

2021  
KATALOĐU  
CATALOGUE

*konusulan  
the spoken kalite...  
quality...  
qualitt ber die  
man spricht...*



[www.akko.com.tr](http://www.akko.com.tr)

 **AKKO**<sup>®</sup>

Kesici U ve Bađlama Sistemleri  
Cutting Inserts and Connection Systems  
Trgerwerkzeuge fr Wendeschneidplatten

*konusulan*  
*the spoken* kalite...  
*quality...*











TS EN ISO 9001:2015







1986 yılında Abdullah KARAKUŞ tarafından kurulan AKKO Oto. Mak. Hırd. San. Tic. Ltd. Şti. Tornalama Takımları, Diş ve Kanal Açma Takımları, Delik Delme Takımları, Frezeleme Takımları ve Özel Takımları üretmektedir. Şu an 8000 m<sup>2</sup> ye yakın bir alanda Türkiye, Japonya, Almanya, İsviçre gibi ülkelerin ürettikleri son teknoloji tezgah ve ekipmanlarıyla yıllık 500.000 adet üretim kapasitesiyle, standart 8000 çeşit takım üretimi yapmaktadır. Avrupa, Asya, Afrika, Güney Amerika ve Orta Doğu'da şimdilik 75 ülkeye ürün sevkiyatına devam etmekte olup 300.000 adet civarında üretilmiş ürün stoklarında mevcuttur. Firmaya, özel üretilen çelik hammadde işleme girer ve bütün üretim süreci bünyesinde gerçekleşir. Çeliğin işlenmesi, ısıl işlemi, üzerindeki kaplama ve her türlü üretim süreci bir entegre tesis olan AKKO'da gerçekleşir.

We as AKKO Oto. Mak. Hırd. San. Tic. Ltd. Şti, which has been founded by Abdullah KARAKUŞ in 1986, produce Turning Tool Holders, Threading and Grooving Tool Holders, U-Drills, Milling Tool Holders and Precision Tool Holders ( OEM Tool Holders ). We produce standard 8000 kinds of tool holders with production capacity of 500.000 pieces per annum in an area about 8000 square meter. We are going on exporting 75 countries including European, Asian, African, South American Countries and Middle East Countries. We keep ready about 300.000 pieces produced products in our stock. Steel Raw materials that we make produced especially for us are delivered our factory and all production process are made in our factory. All kind of process from machining of steel to heat treatment and coating on our tools are made in our integrated factory AKKO.



*Die Fa. Akko wurde 1986 von Abdullah Karakuş gegründet und produziert Dreh-, Gewinde- und Stechwerkzeuge für Wendeschneidplatten. Ebenso gehören Wendeplattenbohrer, Wendeplattenfräser und Sonderwerkzeuge für Wendeplatten zum Lieferprogramm. Alle Werkzeuge sind auch als OEM-Version lieferbar. Wir fertigen 8000 verschiedene Standardartikel auf einer Fläche von 8000 Quadratmetern. Unsere jährliche Produktionsmenge beträgt ca. 500000 Stück. Wir exportieren in 75 verschiedene Länder in Europa, Asien, Afrika, Südamerika und Mittlerer Osten. Unsere Lagerkapazität beträgt ca. 300000 Stück. Das eingesetzte Rohmaterial wird speziell für unsere Firma produziert. Alle weiteren Produktionsschritte wie z.B. mechanische Bearbeitung, Wärmebehandlung und Beschichtung unserer Werkzeuge erfolgen auf unseren eigenen Maschinenanlagen.*



<b>KESİCİ UÇLAR ve TAKIMLARI</b>	
S11-S14	POLY-V KANAL AÇMA UÇLARI ve TAKIMLARI
S15-S16	KANAL AÇMA, KOŞE BOŞALTMA UÇLARI ve TAKIMLARI
S17-S21	BROŞ ÇEKME UÇLARI ve TAKIMLARI
S22-S25	SUPAP YUVASI İŞLEME UÇLARI ve TAKIMLARI
S26-S29	WHIRLING UÇLARI ve TAKIMLARI

<b>DIŞ TORNA TAKIMLARI</b>	
S33	DIŞ TORNA KATERLERİ KODLAMA SİSTEMİ
S34-S47	T-SİSTEM DIŞ TORNA KATERLERİ
S48-S50	M-SİSTEM DIŞ TORNA KATERLERİ
S51-S62	P-SİSTEM DIŞ TORNA KATERLERİ
S63-S69	C-SİSTEM DIŞ TORNA KATERLERİ
S70-S83	S-SİSTEM DIŞ TORNA KATERLERİ
S83-S87	S-SİSTEM İSVİÇRE TİPİ KAYAR OTOMAT MAKİNA TAKIMLARI
S87-S90	SWISS EASY CHANGE - SEC TOOLS

<b>DELİK TORNA TAKIMLARI</b>	
S92	DELİK TORNA KATERLERİ KODLAMA SİSTEMİ
S93-S98	T&C SİSTEM DELİK TORNA KATERLERİ
S99-S103	M-SİSTEM DELİK TORNA KATERLERİ
S104-S110	P-SİSTEM DELİK TORNA KATERLERİ
S111-S128	S-SİSTEM DELİK TORNA KATERLERİ

<b>TIRLAMAZ TAKIMLAR-ANTI VIBRATION TOOLS</b>	
S130	TIRLAMAZ TAKIMLARIN KODLAMA SİSTEMİ
S131-S136	TIRLAMAZ TAKIMLAR

<b>KARTUŞLAR</b>	
S138	KARTUŞLARIN KODLAMA SİSTEMİ
S139-S141	S-TİP REKTEFİYE KARTUŞLARI
S141-S144	S-SİSTEM KARTUŞLAR
S144-S147	P-SİSTEM KARTUŞLAR VE BORU PAHLAMA TAKIMLARI

<b>DIŞ AÇMA TAKIMLARI</b>	
S149	DIŞ AÇMA KATERLERİ KODLAMA SİSTEMİ
S150-S155	DIŞ AÇMA KATERLERİ ve TEKNİK BİLGİ

<b>KANAL AÇMA TAKIMLARI</b>	
S157	KANAL KATERLERİ KODLAMA SİSTEMİ
S158-S172	DIŞ ÇAP KANAL AÇMA TAKIMLARI
S173-S175	DIŞ ÇAP KANAL AÇMA İSVEÇ TİPİ KAYAR OTOMAT MAKİNA TAKIMLARI
S177-S179	DIŞ ÇAP ALIN KANAL AÇMA TAKIMLARI
S180	L TİP ALIN KANAL AÇMA TAKIMLARI
S180-S182	KESME VE DERİN KANAL AÇMA LAMALARI
S182	KESME VE DERİN KANAL AÇMA LAMA BLOĞU
S184-S186	İÇTEN SOĞUTMA KANALLI KANAL AÇMA TAKIMLARI
S187-S198	DELİK İÇİ KANAL KATERLERİ

<b>DELİK DELME ve İŞLEME TAKIMLARI</b>	
S199-S227	TAKMA UÇLU MATKAPLAR ve KODLAMA SİSTEMİ
S228-S229	DELİK PAHLAMA TAKIMI VE MONTAJ ŞEKLİ
S230	EKSANTRİK TAKMA UÇLU MATKAP ADAPTÖRÜ
S231	ÖZEL DELİK DELME ve İŞLEME TAKIMI SİPARİŞ FORMU
S232-S234	EKONOMİK KESİCİLER ve KODLAMA SİSTEMİ
S235-S240	AYARLI DELİK İŞLEME BARALARI ve KODLAMA SİSTEMİ

<b>FREZELEME TAKIMLARI</b>	
S242	FREZELEME TAKIMLARI KODLAMA SİSTEMİ
S243-S244	S-SİSTEM PAH FREZELER
S244	HELİS PAH FREZELEME TAKIMLARI
S245	SİLİNDİRİK ALYAN BAŞLI VİDA (DIN 974-1) HAVŞALARINI AÇMA FREZELERİ
S246-S271	S-SİSTEM YÜZEY PARMAK FREZELER
S271-S274	S-SİSTEM YÜZEY ve KOPYA PARMAK FREZELER
S274-S285	S-SİSTEM HIZLI İLERLEMELİ PARMAK FREZELER
S285-S295	S-SİSTEM MODÜLER PARMAK FREZELER
S295-S303	S-SİSTEM HIZLI İLERLEMELİ MODÜLER PARMAK FREZELER
S304-S305	KÜRE UÇLU PARMAK FREZELER
S306-S307	MODÜLER KÜRE UÇLU PARMAK FREZELER
S308	VİDALI TAKIM TUTUCULARI
S308-S309	DIŞ AÇMA FREZELEME TAKIMLARI
S310	S-SİSTEM HELİS FREZELER
S312-S346	YÜZEY FREZELER
S347-S350	YÜZEY ve KOPYA FREZELER
S351-S353	C-SİSTEM YÜZEY FREZELER
S354-S361	HIZLI İLERLEMELİ FREZELER
S362-S363	T KANAL FREZELER
S364-S365	DİSK FREZELER
S366-S370	FREZELEME TAKIMLARI MONTAJ ÖLÇÜLERİ ve TEKNİK BİLGİLER

<b>YEDEK PARÇALAR</b>	
S372-S385	YEDEK PARÇALAR
S386-S390	ÜRÜN GURUPLARINA GÖRE İÇİNDEKİLER

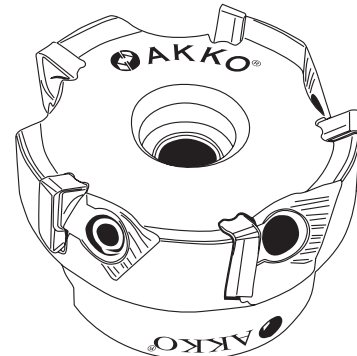
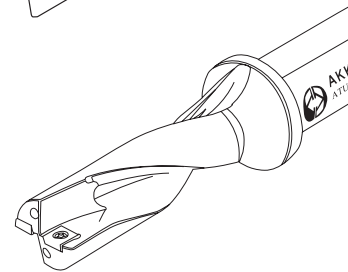
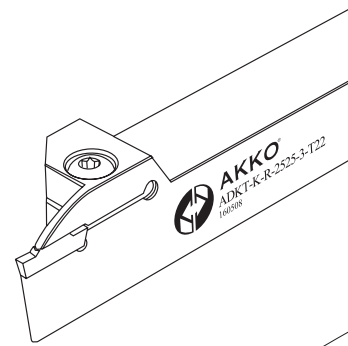
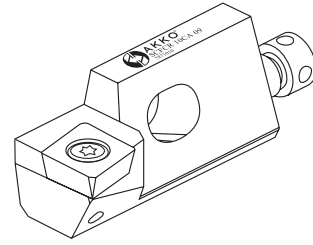
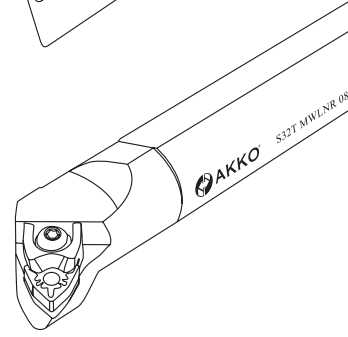
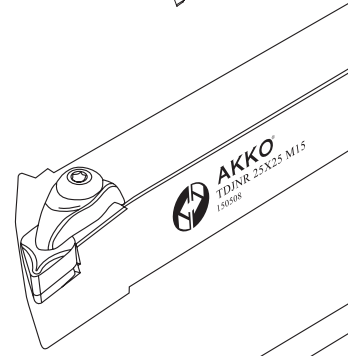
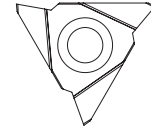

**İÇİNDEKİLER**



# CONTENTS

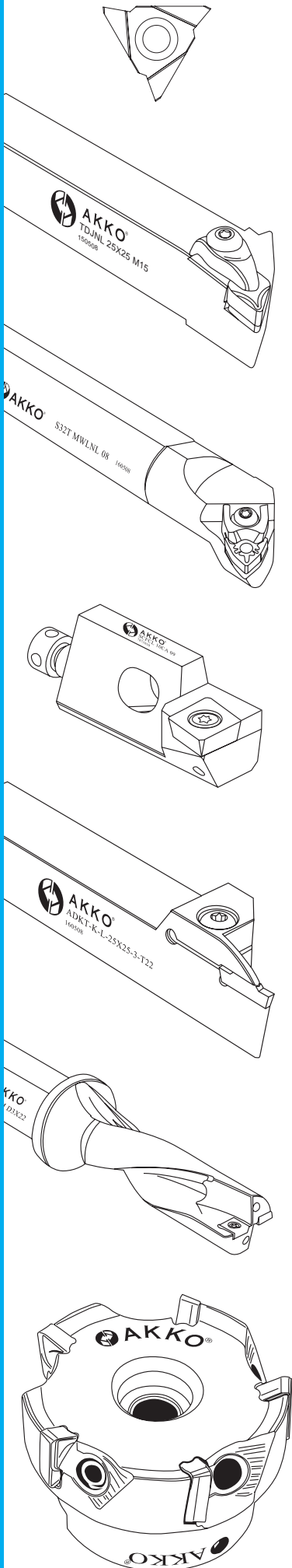

## CUTTING INSERTS and TOOLHOLDERS

POLY-V GROOVING INSERTS and TOOLHOLDERS  
 INSERTS and TOOLHOLDERS FOR GROOVING CORNER RELIEFS  
 BROACHING INSERTS and TOOLHOLDERS  
 VALVE SEAT INSERTS and TOOLHOLDERS  
 WHIRLING INSERTS and TOOLHOLDERS

P11-P14  
 P15-P16  
 P17-P21  
 P22-P25  
 P26-P29

## EXTERNAL TURNING TOOLHOLDERS

EXTERNAL TURNING TOOLHOLDERS DESIGNATION SYSTEM  
 T-SYSTEM EXTERNAL TURNING TOOLHOLDERS  
 M-SYSTEM EXTERNAL TURNING TOOLHOLDERS  
 P-SYSTEM EXTERNAL TURNING TOOLHOLDERS  
 C-SYSTEM EXTERNAL TURNING TOOLHOLDERS  
 S-SYSTEM EXTERNAL TURNING TOOLHOLDERS  
 S-SYSTEM TOOLS FOR SWISS TYPE SLIDING AUTOMATIC LATHES  
 SEC TOOLS

P33  
 P34-P47  
 P48-P50  
 P51-P62  
 P63-P69  
 P70-P83  
 P83-P87  
 P87-P90

## INTERNAL TURNING TOOLHOLDERS

BORING BARS DESIGNATION SYSTEM  
 T&C SYSTEM BORING BARS  
 M-SYSTEM BORING BARS  
 P-SYSTEM BORING BARS  
 S-SYSTEM BORING BARS

P92  
 P93-P98  
 P99-P103  
 P104-P110  
 P111-P128

## ANTIVIBRATION TOOLS

ANTIVIBRATION TOOL DESIGNATION SYSTEM  
 ANTIVIBRATION TOOLS

P130  
 P131-P136

## CARTRIDGE

CARTRIDGE DESIGNATION SYSTEM  
 S-TYPE ENGINE OVERHAUL CARTRIDGE  
 S-SYSTEM CARTRIDGE  
 P-SYSTEM CARTRIDGE AND PIPE BEVELING and CHAMFERING TOOLS

P138  
 P139-P141  
 P141-P144  
 P144-P147

## THREADING TOOLHOLDERS

THREADING TOOLHOLDERS DESIGNATION SYSTEM  
 THREADING TOOLHOLDERS and TECHNICAL INFORMATION

P149  
 P150-P155

## GROOVING TOOLHOLDERS

GROOVING TOOLHOLDERS DESIGNATION SYSTEM  
 EXTERNAL GROOVING TOOLHOLDERS  
 EXTERNAL GROOVING TOOLHOLDERS FOR SWISS TYPE SLIDING AUTOMATIC LATHES  
 FACE EXTERNAL GROOVING TOOLHOLDERS  
 L TYPE FACE EXTERNAL GROOVING TOOLHOLDERS  
 BLADES FOR PARTING AND DEEP GROOVING  
 BLOCKS FOR PARTING AND DEEP GROOVING BLADES  
 EXTERNAL GROOVING TOOLHOLDERS WITH COOLANT TOOLS  
 INTERNAL GROOVING TOOLHOLDERS

P157  
 P158-P172  
 P173-P175  
 P177-P179  
 P180  
 P180-P182  
 P182  
 P184-P186  
 P187-P198

## DRILLING and HOLEMAKING TOOLS

U-DRILL SYSTEM and DESIGNATION SYSTEM  
 DRILL CHAMFERING RING TOOLS and MOUNTING SYSTEM  
 EXCENTRIC ADAPTOR FOR U-DRILLS  
 SPECIAL DRILL ORDER FORM  
 ECONOMIC CUTTING TOOLS and DESIGNATION SYSTEM  
 ADJUSTABLE BORING HEADS and DESIGNATION SYSTEM

P199-P227  
 P228-P229  
 P230  
 P231  
 P232-P234  
 P235-P240

## MILLING TOOLS

MILLING TOOLS DESIGNATION SYSTEM  
 S-SYSTEM CHAMFERING END MILLS  
 HELIX CHAMFER MILLING TOOLS  
 COUNTERSINK MILLING TOOL FOR CYLINDRICAL ALLEN HEAD SCREWS (DIN 974-1)  
 S-SYSTEM END MILLS  
 S-SYSTEM FACE and COPY END MILLS  
 S-SYSTEM HIGHFEED END MILLS  
 S-SYSTEM MODULAR END MILLS (SCREW TYPE TOOLS)  
 S-SYSTEM MODULAR (SCREW TYPE) HIGHFEED END MILLS  
 BALL NOSE MILLS  
 BALL NOSE MODULAR (SCREW TYPE) END MILLS  
 SCREWED TOOL HOLDERS  
 THREAD MILLING TOOLS  
 S-SYSTEM HELIX END MILL  
 FACE MILLING  
 FACE and COPY MILLING TOOLS  
 C-SYSTEM FACE MILLING  
 HIGH FEED MILLING TOOLS  
 T SLOT MILLING  
 DISC MILLING  
 MOUNTING REFERENCE FOR MILLING CUTTERS and TECHNICAL INFORMATION

P242  
 P243-P244  
 P244  
 P245  
 P246-P271  
 P271-P274  
 P274-P285  
 P285-P295  
 P295-P303  
 P304-P305  
 P306-P307  
 P308  
 P308-P309  
 P310  
 P312-P346  
 P347-P350  
 P351-P353  
 P354-P361  
 P362-P363  
 P364-P365  
 P366-P370

## SPARE PARTS

SPARE PARTS  
 INDEX

P372-P385  
 P386-P390



	<b>WENDESCHNEIDPLATTEN und WERKZEUGE</b>
P11-P14	POLY-V EINSTECHPLATTEN UND WERKZEUGE
P15-P16	WENDESCHNEIDPLATTEN UND WERKZEUGE FÜR AXIAL FREISTICHE
P17-P21	WENDESCHNEIDPLATTEN UND WERKZEUGHALTER FÜR DIE NUTBEARBEITUNG
P22-P25	WENDESCHNEIDPLATTEN UND WERKZEUGE FÜR VENTILSITZE
P26-P29	WENDESCHNEIDPLATTEN UND WERKZEUGHALTER ZUM GEWINDEWIRBELN

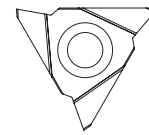

	<b>DREHEN - AUßENDREHHALTER</b>
P33	BEZEICHNUNGSSCHLÜSSEL FÜR DREHALTER AUßENBEARBEITUNG
P34-P47	T-SYSTEM AUSSEN - DREHHALTER
P48-P50	M-SYSTEM AUSSEN - DREHHALTER
P51-P62	P SYSTEM AUSSEN - DREHHALTER
P63-P69	C SYSTEM AUSSEN - DREHHALTER
P70-P83	S SYSTEM AUSSEN - DREHHALTER
P83-P87	S-SYSTEM FÜR LANGDREHAUTOMATEN
P87-P90	SEC TOOLS

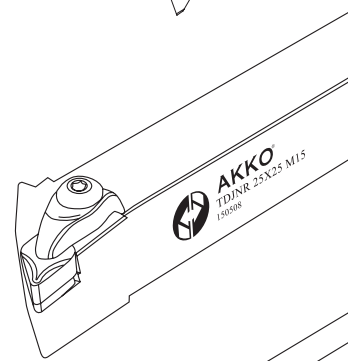

	<b>DREHWERKZEUGE FÜR DIE INNENBEARBEITUNG</b>
P92	BOHRSTANGE BEZEICHNUNGSSYSTEM
P93-P98	T&C SYSTEM BOHRSTANGE
P99-P103	M-SYSTEM BOHRSTANGE
P104-P110	P- SYSTEM BOHRSTANGE
P111-P128	S- SYSTEM BOHRSTANGE

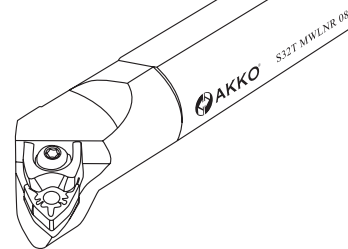

	<b>ANTIVIBRATION TOOLS</b>
P130	ANTIVIBRATION TOOL DESIGNATION SYSTEM
P131-P136	ANTIVIBRATION TOOLS

	<b>KURZDREHHALTER</b>
P138	KURZDREHHALTER BEZEICHNUNGSSYSTEM
P139-P141	S-SYSTEM KURZDREHHALTER FÜR DIE MOTORINSTANDHALTUNG
P141-P144	S-SYSTEM KURZDREHHALTER
P144-P147	S-SYSTEM KURZDREHHALTER

	<b>GEWINDE DREHHALTER</b>
P149	GEWINDE DREHHALTER BEZEICHNUNGSSYSTEM
P150-P155	AUSSEN-GEWINDEDREHHALTER

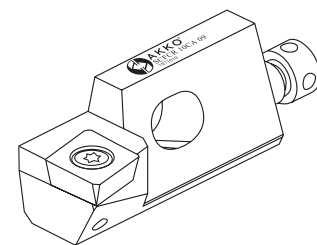

	<b>STECHHALTER</b>
P157	STECHHALTER BEZEICHNUNGSSYSTEM
P158-P172	AUßEN-STECHHALTER
P173-P175	WERKZEUGE ZUR STECHBEARBEITUNG AUF LANGDREHAUTOMATEN
P177-P179	AXIAL-STECHHALTER
P180	AXIAL STECHHALTER L-TYPE
P180-P182	STECHSCHWERT FÜR ABSTECHEN UND TIEFE EINSTICHE
P182	SPANNBLOCK FÜR STECHSCHWERT
P184-P186	EXTERNE NUTWERKZEUGHALTER MIT KÜHLWERKZEUG
P187-P198	INNEN-STECHHALTER

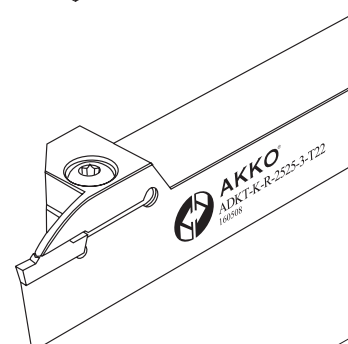

	<b>BOHRWERKZEUGE</b>
P199-P227	VOLLBOHRER / BEZEICHNUNGSSYSTEM FÜR VOLLBOHRER
P228-P229	FASRING FÜR VOLLBOHRER
P230	EXENTRISCHER ADAPTER FÜR WENDEPLATTENBOHRER
P231	BESTELLFORMULAR FÜR SONDERBOHRER
P232-P234	BEZEICHNUNGSSYSTEM FÜR MULTIFUNKTIONALES DREH-UND BOHRWERKZEUG / BOHREN, INNEN-UND AUßENDREHEN
P235-P240	BEZEICHNUNGSSYSTEM FÜR EINSTELLBBARE SPINDELKÖPFE / EINSTELLBARE SPINDELKÖPFE

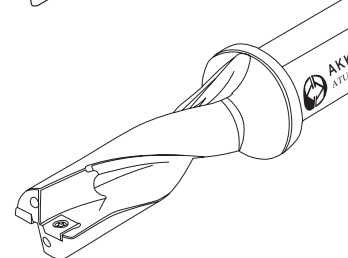

	<b>FRÄSWERKZEUGE</b>
P242	BEZEICHNUNGSSYSTEM FÜR FRÄSER
P243-P244	S-SYSTEM FASFRÄSER
P244	HELIX-FASFRÄSER
P245	SENKWERKZEUG FÜR ZYLINDERKOPFSCHRAUBEN (DIN 974-1)
P246-P271	S-SYSTEM SCHAFTFRÄSER
P271-P274	S-SYSTEM KOPIER- UND SCHAFTFRÄSER
P274-P285	S-SYSTEM HOCHVORSCHUB- SCHAFTFRÄSER
P285-P295	S-SYSTEM EINSCHRAUBFRÄSER
P295-P303	S-SYSTEM HOCHVORSCHUB-EINSCHRAUBFRÄSER
P304-P305	KUGELKOPIERFRÄSER
P306-P307	MODULARE EINSCHRAUB-KUGELFRÄSER
P308	AUFNAHME FÜR EINSCHRAUBFRÄSER
P308-P309	GEWINDEFÄSERWERKZEUGE
P310	S-SYSTEM WENDELSCHAFTFRÄSER
P312-P346	PLAN UND ECKMESSERKÖPFE
P347-P350	MESSERKÖPFE FÜR RUNDE WENDESCHNEIDPLATTEN
P351-P353	PLAN UND ECKMESSERKÖPFE
P354-P361	HOCHVORSCHUBFRASER
P362-P363	T-NUTENFRASER
P364-P365	SCHEIBENFRASER
P366-P370	ABMESSUNGEN DER AUFNAHMEBOHRUNGEN FÜR MESSERKÖPFE

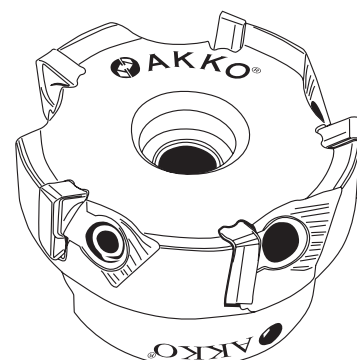

	<b>ERSATZTEILE</b>
P372-P385	ERSATZTEILE
P386-P390	INDEX



***konusulan***  
***the spoken kalite...***  
***quality...***





**KESİCİ UÇLAR ve TAKIMLARI**

*CUTTING INSERTS and TOOLHOLDERS*

*WENDESCHNEIDPLATTEN und WERKZEUGE*

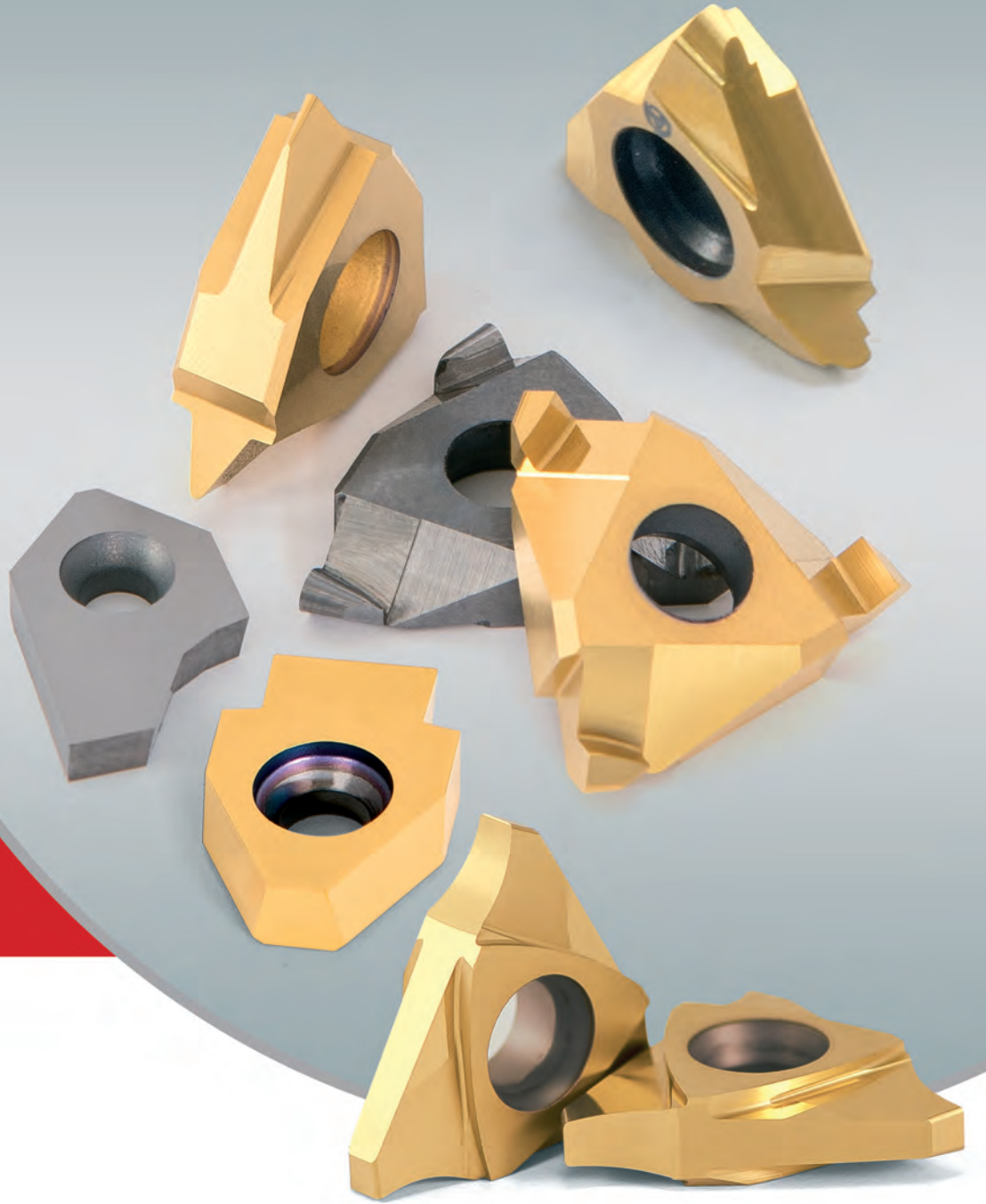



# POLY-V

**POLY-V KANAL AÇMA UÇLARI ve TAKIMLARI**  
*POLY-V GROOVING INSERTS and TOOLHOLDERS*  
*POLY-V EINSTECHPLATTEN UND WERKZEUGE*

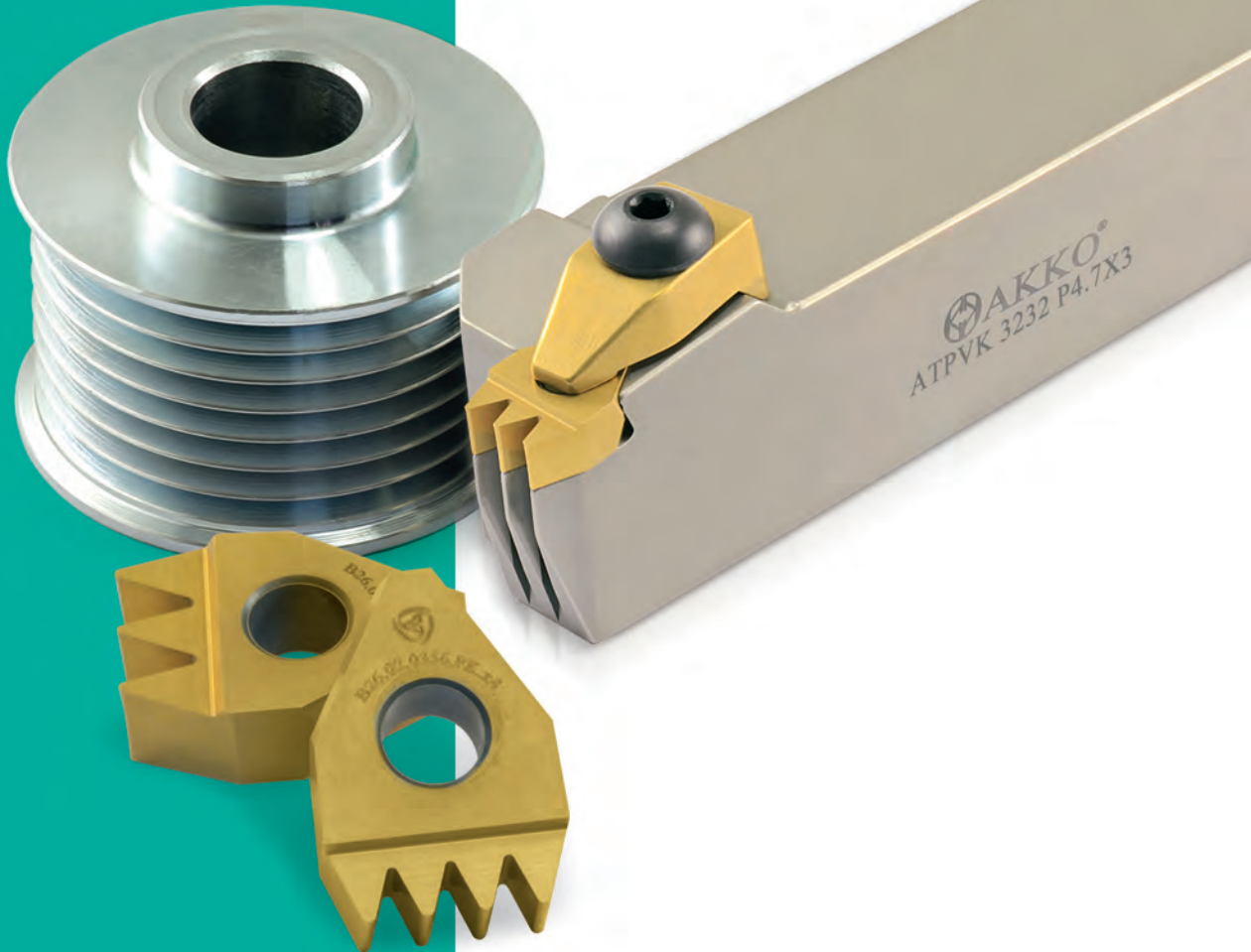

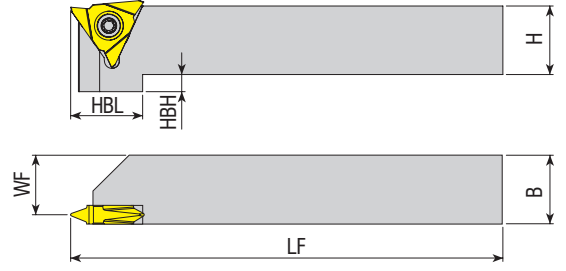

Takım Kodu Ordering Code Bestell-Bezeichnung	Stok Stock Lager		Takım Ölçüleri (mm) Dimension (mm) Abmessung (mm)					Kesici Uç Insert Wendeschneidplatte	Yedek Parçaları / Spare Parts / Ersatzteile		
	R	L	H	B	WF	LF	HBL		HBH	Sıkma Vidası Screw Schraube	Tork Anahtar Torx Key Torx-Schlüssel
ADKT-T12P-R/L-1616-T5	●	●	16	16	13.50	125	21	5			
ADKT-T12P-R/L-2020-T5	●	●	20	20	17.50	125	21	5			
ADKT-T12P-R/L-2525-T5	●	●	25	25	22.50	150	-	-			
ADKT-T12P-R/L-3232-T5	●	●	32	32	29.50	170	-	-			

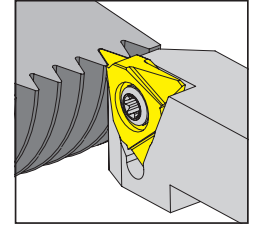
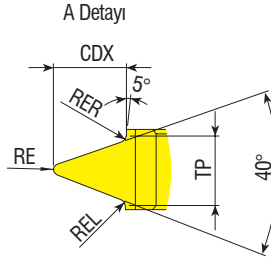
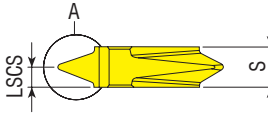
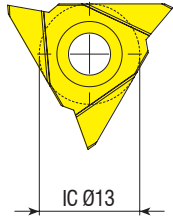
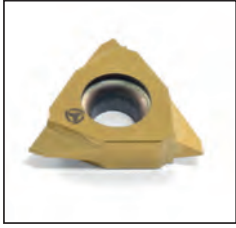

Uç Kodu Insert Code Wendeplatten-Bezeichnung	Stok Stock Lager		Uç Ölçüleri (mm) Insert Dimension (mm) Abmessung (mm)						Kalite Grade Sorte
	R	L	TP	S	RE	RER / REL	LSCS	CDX	
T12.10.0234.PJ.R	●	●	2.34	5.20	0.36	0.24	2.60	2.08	VK20F01
T12.10.0356.PK.R	●	●	3.56	5.20	0.44	0.35	2.60	3.40	VK20F01
T12.10.0470.PL.R	●	●	4.70	5.20	0.36	0.45	2.60	4.90	VK20F01

R: Sağ / Right / Rechts L: Sol/Left/Links

● Stokta / In Stock / Auf Lager ○ Stokta Yok / Non Stock Item / Kein Lagerartikel, Lieferzeit auf Anfrage

ADKT-T12P...Tipi katerler ile kullanınız. / Use with ADKT-T12P... Type toolholder. / Einsatz mit ADKT-T12P...-Werkzeughalter  
İndekslenliğinde boy  $\pm 0,02$ mm / Indexability length  $\pm 0,02$ mm | Wiederholgenauigkeit Länge  $\pm 0,02$  mm

Diğer ölçü talepleriniz için müşteri temsilciniz ile irtibata geçiniz. / For other dimension request, contact with customer representative. / Für weitere Abmessungen kontaktieren Sie bitte den Vertrieb.

Sipariş Örneği/Ordering Example/Bestellbeispiel

1 ad./pcs./stück ADKT-T12P-R-1616-T5



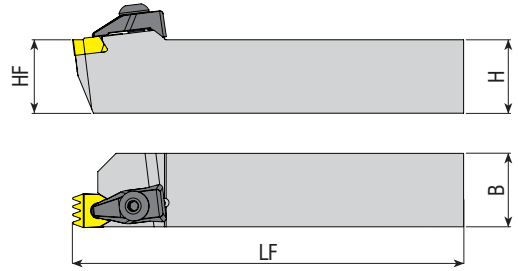

Takım Kodu Ordering Code Bestell-Bezeichnung	Stok Stock Lager		Takım Ölçüleri (mm) Dimension (mm) Abmessung (mm)			Kesici Uç Insert Wendeschneidplatte	Baskı Pabucu Wedge Clamp Spannpratze	Pabuç Vidası Clamp Screw Klemmschraube	Anahtar Allen Key Innensechskantschlüssel
	R	L	HF=H	B	LF				
ATPVK 2020 K2.34X4	○	○	20	20	125	B26.07.0234PJ.x4	ATK-04	AKV-19-M7X25	AAL-05-4
ATPVK 2525 M2.34X4	○	○	25	25	150				
ATPVK 3232 P2.34X4	●	○	32	32	170				
ATPVK 2020 K3.56X4	○	○	20	20	125				
ATPVK 2525 M3.56X4	○	○	25	25	150	B26.07.0356PK.x4	ATK-04	AKV-19-M7X25	AAL-05-4
ATPVK 3232 P3.56X4	●	○	32	32	170				
ATPVK 2020 K4.7X3	○	○	20	20	125	B26.07.0470PL.x3	ATK-04	AKV-19-M7X25	AAL-05-4
ATPVK 2525 M4.7X3	○	○	25	25	150				
ATPVK 3232 P4.7X3	●	○	32	32	170				

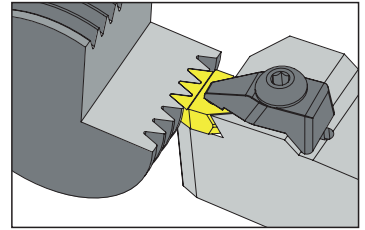
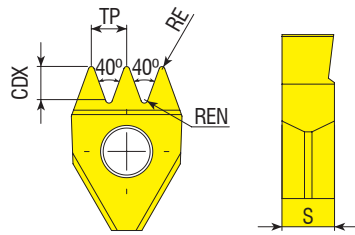

Uç Kodu Insert Code Wendepplatten-Bezeichnung	Stok Stock Lager	Uç Ölçüleri (mm) Insert Dimension (mm) Abmessung (mm)					Kalite Grade Sorte
		TP	S	RE	REN	CDX	
B26.07.0234.PJx4	●	2.34	7	0.36	0.24	2.08	VK10F01
B26.07.0356.PKx4	●	3.56	7	0.45	0.35	3.35	VK10F01
B26.07.0470.PLx3	●	4.70	7	0.38	0.45	4.85	VK10F01

R: Sağ / Right / Rechts L: Sol/Left/Links  
● Stokta / In Stock / Auf Lager ○ Stokta Yok / Non Stock Item / Kein Lagerartikel, Lieferzeit auf Anfrage

Sipariş Örneği/Ordering Example/Bestellbeispiel  
1 ad./pcs./stück ATPVK 2020 K2.34X4

**konusulan**  
**the spoken kalite...**  
**quality...**





# KANAL AÇMA

**KANAL AÇMA, KÖŞE BOŞALTMA UÇLARI ve TAKIMLARI**  
*INSERTS and TOOLHOLDERS FOR GROOVING CORNER RELIEFS*  
*WENDESCHEIDPLATTEN UND WERKZEUGE FÜR*  
*AXIAL FREISTICHE*



**AKKO®**  
AAUT-T20-R-25



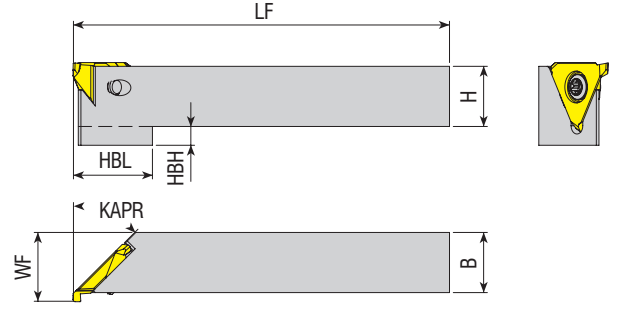

Takım Kodu Ordering Code Bestell-Bezeichnung	Stok Stock Lager		Takım Ölçüleri (mm) Dimension (mm) Abmessung (mm)						Kesici Uç Insert Wendeschneidplatte	Sıkma Vidası Screw Schraube	Tork Anahtar Torx Key Torx-Schlüssel	
	R	L	H	B	WF	LF	HBL	HBH	KAPR			
AAUT-T20-R/L-1616-45	●	●	16	16	18.3	125	21	5	45°			
AAUT-T20-R/L-2020-45	●	●	20	20	22.3	125	21	5	45°	T20...	1020-M5x7.5	80-T20
AAUT-T20-R/L-2525-45	●	●	25	25	27.3	150	-	-	45°			

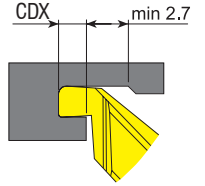
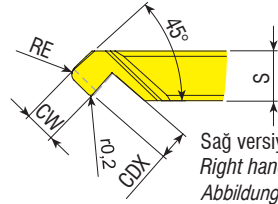
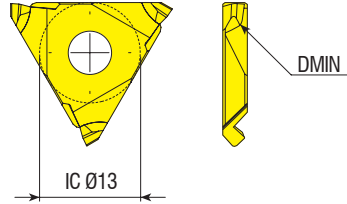

Sağ versiyon gösterilmiştir  
 Right hand version shown  
 Abbildung zeigt rechte Ausführung

Uç Kodu Insert Code Wendeplatten-Bezeichnung	Stok Stock Lager		Uç Ölçüleri (mm) Insert Dimension (mm) Abmessung (mm)				Kalite Grade Sorte	Minimum Çap Ø Minimum Diameter Ø Kleinsten Durchmesser a	Kanal Derinliği Depth of Groove Up to Stechtiefe bis zu	Kanal Genişliği Width of Groove Stechbreite	
	R	L	CW	S	RE	CDX					DMIN
T20.00.0815.45.04R/L	●	●	1.5	3.25	0.4	1.6	8	VK20F01	8	1.6	1.5
T20.00.1220.45.05R/L	●	●	2.0	3.25	0.5	1.8	12	VK20F01	12	1.8	2.0
T20.00.2024.45.06R/L	●	●	2.4	3.25	0.6	2.0	20	VK20F01	20	2.0	2.4

AAUT.. Tipi katerlerle kullanınız. / Use with AAUT type toolholder. / Einsatz mit AAUT-Werkzeughalter  
 Kullanım öncesinde dip boşluk işlenmiş olmalıdır. / The undercut must be placed before axial machining. / Der Freistich muss vor der Axialbearbeitung gefertigt werden  
 İndekslenişinde boy ±0.02mm / Indexability length ±0.02mm / Wiederholgenauigkeit Länge ± 0,02 mm

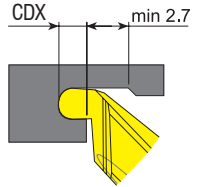
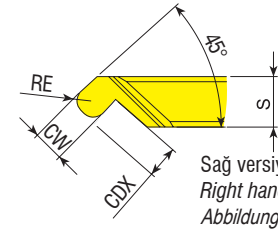
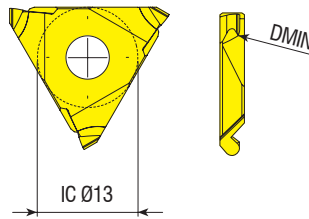
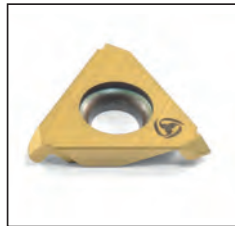

Sağ versiyon gösterilmiştir  
 Right hand version shown  
 Abbildung zeigt rechte Ausführung

Uç Kodu Insert Code Wendeplatten-Bezeichnung	Stok Stock Lager		Uç Ölçüleri (mm) Insert Dimension (mm) Abmessung (mm)				Kalite Grade Sorte	Minimum Çap Ø Minimum Diameter Ø Kleinsten Durchmesser a	Kanal Derinliği Depth of Groove Up to Stechtiefe bis zu	Kanal Genişliği Width of Groove Stechbreite	
	R	L	CW	S	RE	CDX					DMIN
T20.00.1220.45.10R/L	●	●	2.0	3.25	1.0	1.8	12	VK20F01	12	1.8	2

AAUT.. Tipi katerlerle kullanınız. / Use with AAUT type toolholder. / Einsatz mit AAUT-Werkzeughalter  
 Kullanım öncesinde dip boşluk işlenmiş olmalıdır. / The undercut must be placed before axial machining. / Der Freistich muss vor der Axialbearbeitung gefertigt werden  
 İndekslenişinde boy ±0.02mm / Indexability length ±0.02mm / Wiederholgenauigkeit Länge ± 0,02 mm

R: Sağ / Right / Rechts L: Sol/Left/Links  
 ● Stokta / In Stock / Auf Lager ○ Stokta Yok / Non Stock Item / Kein Lagerartikel, Lieferzeit auf Anfrage

Sipariş Örneği/Ordering Example/Bestellbeispiel  
 1 ad./pcs./stück AAUT-T20-R-1616-45



# BROŞ

**BROŞ ÇEKME UÇLARI ve TAKIMLARI**

*BROACHING INSERTS and TOOLHOLDERS*

*WENDESCHNEIDPLATTEN UND WERKZEUGHALTER FÜR  
DIE NUTBEARBEITUNG*

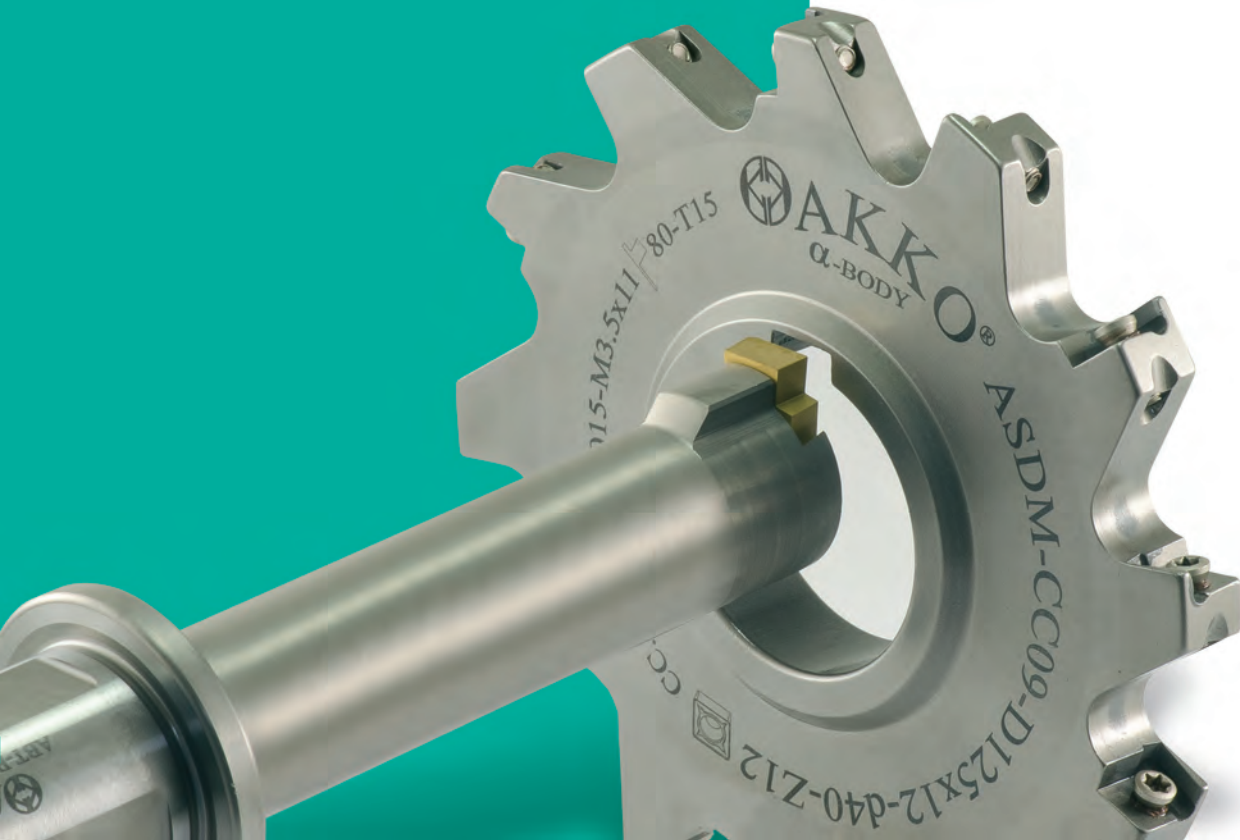
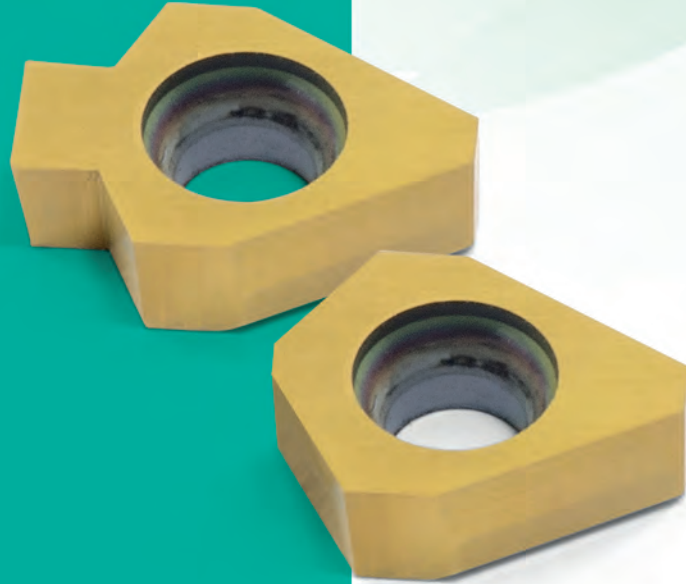

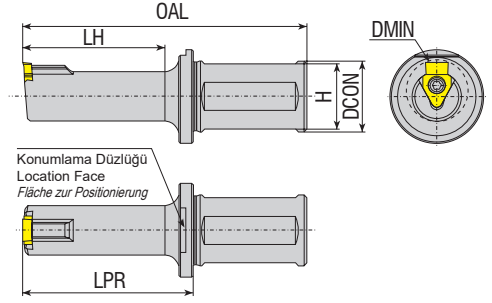

Takım Kodu Ordering Code Bestell-Bezeichnung	Stok Stock Lager	Takım Ölçüleri (mm) Dimension (mm) Abmessung (mm)						Kesici Uç Insert Wendeschneidplatte	Yedek Parçaları / Spare Parts / Ersatzteile	
		DMIN	LH	DCON	OAL	LPR	H		Sıkma Vidası Screw Schraube	Tork Anahtar Torx Key Torx-Schlüssel
ABT-B41-D17-Y25-L90-I040	●	17	40	25	90	50	23	B41...	4015-M4x11	80-T15
ABT-B41-D17-Y25-L105-I065	●	17	65	25	105	75	23			
ABT-B41-D22-Y25-L100-I050	●	22	50	25	100	60	23			
ABT-B41-D22-Y25-L125-I070	●	22	70	25	125	80	23			
ABT-B42-D30-Y32-L100-I050	●	30	50	32	100	60	30	B42...	1020-M5x14	80-T20
ABT-B42-D30-Y32-L125-I075	●	30	75	32	125	85	30			
ABT-B42-D30-Y32-L170-I110	●	30	110	32	170	120	30			
ABT-B42-D38-Y32-L100-I050	●	38	50	32	100	60	30			
ABT-B42-D38-Y32-L125-I075	●	38	75	32	125	85	30			
ABT-B42-D40-Y32-L100-I050	●	40	50	32	100	60	30			
ABT-B42-D40-Y32-L125-I075	●	40	75	32	125	85	30			

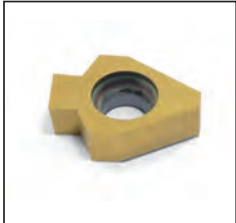

DIN138 (Tolerans C11) torna ve freze tezgahlarında broş çekme uçları.  
DIN138 (Tolerance C11) inserts for keyway broaching on lathe and milling machines.  
DIN 138 (Toleranz C11) Wendepplatten für Keilnutenfertigung auf Dreh- und Fräsmaschinen

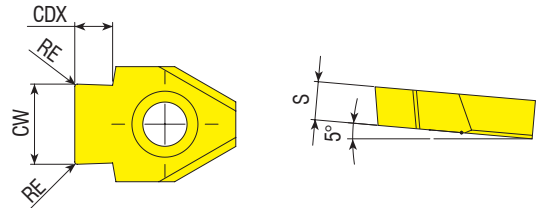

Uç Kodu Insert Code Wendepplatten-Bezeichnung	Stok Stock Lager	Uç Ölçüleri (mm) Insert Dimension (mm) Abmessung (mm)				
		CW	RE	CDX	S	DMIN
B41.00.0612.085.VP3001	●	6.12	0.85	2.6	4.0	22
B41.00.0713.085.VP3001	●	7.13	0.85	3.3	4.0	22
B41.00.0813.105.VP3001	●	8.13	1.05	3.4	4.0	22
B42.00.1013.105.VP3001	●	10.13	1.05	4.2	6.0	30
B42.00.1215.135.VP3001	●	12.15	1.35	5.1	6.0	38
B42.00.1215.175.VP3001	●	12.15	1.75	6.6	6.0	38
B42.00.1215.225.VP3001	●	12.15	2.25	8.5	6.0	38

Tipik kesme şartları / Typical cutting conditions / Standard-Schneidbedingungen: İlerleme (Vf): 3000-8000 mm/dak (min) / Paso (ap): 0.02-0.08 mm / Vorschub (Vf): 3000-8000 mm/min

R: Sağ / Right / Rechts L: Sol/Left/Links

● Stokta / In Stock / Auf Lager ○ Stokta Yok / Non Stock Item / Kein Lagerartikel, Lieferzeit auf Anfrage

Sipariş Örneği/Ordering Example/Bestellbeispiel  
1 ad./pcs./stück ABT-B41-D17-Y25-L90-I040



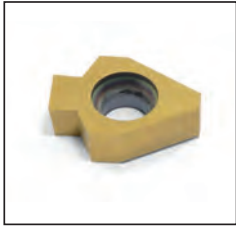

DIN6885 (Tolerans P9) torna ve freze tezgahlarında broş çekme uçları.  
DIN6885 (Tolerance P9) inserts for keyway broaching on lathe and milling machines.  
DIN6885 (Toleranz P9) Wendeplatten für Keilnutenfertigung auf Dreh- und Fräsmaschinen

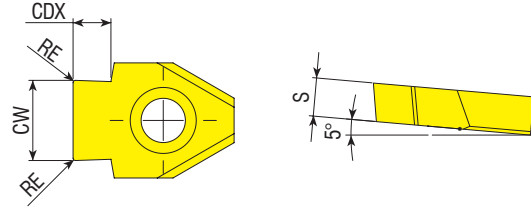

Uç Kodu Insert Code Wendeplatten-Bezeichnung	Stok Stock Lager	Uç Ölçüleri (mm) Insert Dimension (mm) Abmessung (mm)				
		CW	RE	CDX	S	DMIN
B41.00.0498.020.VP3001	●	4.98	0.20	2.7	4.0	17
B41.00.0598.020.VP3001	●	5.98	0.20	3.4	4.0	17
B41.00.0798.020.VP3001	●	7.98	0.20	4.1	4.0	22
B42.00.0998.030.VP3001	●	9.98	0.30	4.2	6.0	30
B42.00.1197.030.VP3001	●	11.97	0.30	5.7	6.0	38
B42.00.1397.030.VP3001	●	13.97	0.30	6.8	6.0	40

Tipik kesme şartları / Typical cutting conditions / Standard-Schneidbedingungen: İlerleme (Vf): 3000-8000 mm/dak (min) / Paso (ap): 0.02-0.08 mm / Vorschub (Vf): 3000-8000 mm/min



DIN6885 (Tolerans JS9) torna ve freze tezgahlarında broş çekme uçları.  
DIN6885 (Tolerance JS9) inserts for keyway broaching on lathe and milling machines.  
DIN6885 (Toleranz JS9) Wendeplatten für Keilnutenfertigung auf Dreh- und Fräsmaschinen

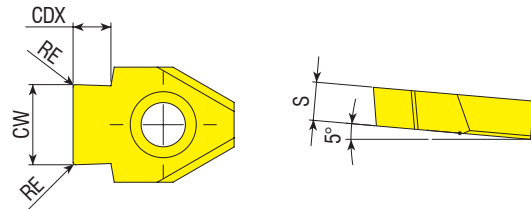

Uç Kodu Insert Code Wendeplatten-Bezeichnung	Stok Stock Lager	Uç Ölçüleri (mm) Insert Dimension (mm) Abmessung (mm)				
		CW	RE	CDX	S	DMIN
B41.00.0501.020.VP3001	●	5.01	0.20	2.7	4.0	17
B41.00.0601.020.VP3001	●	6.01	0.20	3.4	4.0	17
B41.00.0801.020.VP3001	●	8.01	0.20	4.1	4.0	22
B42.00.1001.030.VP3001	●	10.01	0.30	4.2	6.0	30
B42.00.1200.050.VP3001	●	12.00	0.50	8.5	6.0	38
B42.00.1201.030.VP3001	●	12.01	0.30	5.7	6.0	38
B42.00.1401.030.VP3001	●	14.01	0.30	6.8	6.0	40

Tipik kesme şartları / Typical cutting conditions / Standard-Schneidbedingungen: İlerleme (Vf): 3000-8000 mm/dak (min) / Paso (ap): 0.02-0.08 mm / Vorschub (Vf): 3000-8000 mm/min

R: Sağ / Right / Rechts L: Sol/Left/Links

● Stokta / In Stock / Auf Lager ○ Stokta Yok / Non Stock Item / Kein Lagerartikel, Lieferzeit auf Anfrage

Sipariş Örneği/Ordering Example/Bestellbeispiel  
1 ad./pcs./stück B41.00.0498.020.VP3001

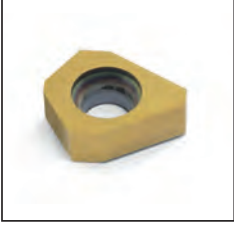

Torna ve freze tezgahlarında kama kanalı pah kırma uçları.  
Inserts for keyway chamfering on lathe and milling machines.  
Wendeschneidplatten zum Anfasen von Keilnuten auf Dreh- und Fräsmaschinen

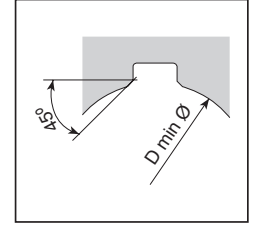
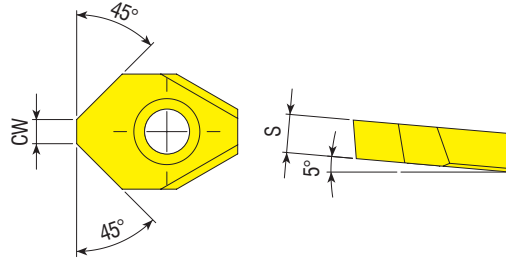

## Uç Kodu

## Insert Code

## Wendepplatten-Bezeichnung

Stok  
Stock  
LagerUç Ölçüleri (mm)  
Insert Dimension (mm)  
Abmessung (mm)

B41.00.0150.CH.VP3001  
B41.00.0300.CH.VP3001  
B42.00.0600.CH.VP3001

●  
●  
●

D<sub>MIN</sub>

CW

S

17

1.5

4.0

22

3.0

4.0

30

6.0

6.0

Tipik kesme şartları / Typical cutting conditions / Standard-Schneidbedingungen: İlerleme (Vf): 3000-8000 mm/dak (min) / Paso (ap): 0.02-0.08 mm / Vorschub (Vf): 3000-8000 mm/min

R: Sağ / Right / Rechts L: Sol/Left/Links

● Stokta / In Stock / Auf Lager ○ Stokta Yok / Non Stock Item / Kein Lagerartikel, Lieferzeit auf Anfrage

Sipariş Örneği/Ordering Example/Bestellbeispiel

1 ad./pcs./stück B41.00.0150.CH.VP3001

PROFİL VERİLMİŞ UÇLAR / PROFILED INSERTS / PROFIL-WENDESCHNEIDPLATTEN  
ÖRNEK PROFİLLER / EXAMPLES OF PROFILES / BEISPIELE FÜR PROFILE

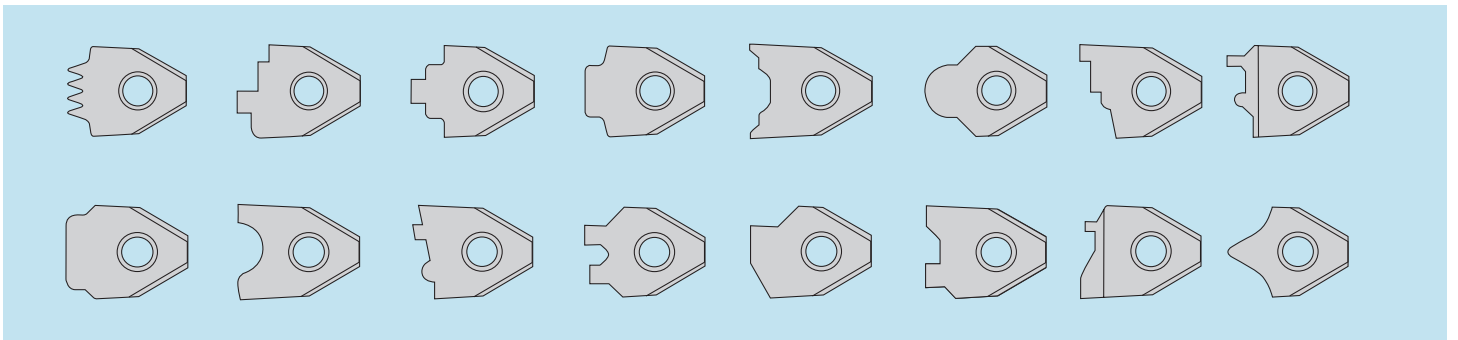

Profil uçlar müşterilerimizin özel taleplerine göre üretilmektedir.  
Profiled inserts are manufactured according to customer special requirements.  
Die Profil-Wendeschneidplatten werden nach Kundenwunsch gefertigt.



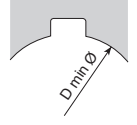
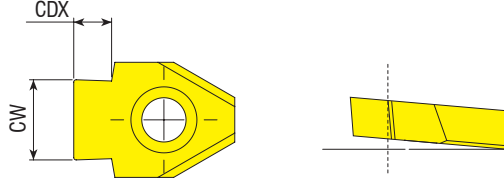

Kanal Geniřliđi Slot With Stechbreite	Tolerans Tolerance Toleranz	Uç Ölçüsü Insert Size mm Abmessung (mm)	W	t <sub>max</sub>	Uçlar Inserts Wendeschneidplatten	Uygulanabilir takım ve uç bağlantısı ile Dmin tablosu Applicable Dmin for toolholders and inserts table Entsprechender dmin für Werkzeuge und Wendeschneidplatten				
						ABT-B41-D17...	ABT-B41-D22...	ABT-B42-D30...	ABT-B42-D38...	ABT-B42-D40...
6	C11	6	6.12	2.6	B41.00.0612.085.VP3001		22	X	X	X
7		7	7.13	3.3	B41.00.0713.085.VP3001		22	X	X	X
8		8	8.13	3.4	B41.00.0813.105.VP3001		22	X	X	X
10		10	10.13	4.2	B42.00.1013.105.VP3001	X	X	30	X	X
12		12		5.1	B42.00.1215.135.VP3001	X	X	X	38	
16		12	12.15	6.6	B42.00.1215.175.VP3001	X	X	X	38	
24		12		8.5	B42.00.1215.225.VP3001	X	X	X	38	
5	P9	5	4.98	2.7	B41.00.0498.020.VP3001	17		X	X	X
6		6	5.98	3.4	B41.00.0598.020.VP3001	17		X	X	X
8		8	7.98	4.1	B41.00.0798.020.VP3001		22	X	X	X
10		10	9.98	4.2	B42.00.0998.030.VP3001	X	X	30		
12		12	11.97	5.7	B42.00.1197.030.VP3001	X	X		38	
14		14	13.97	6.8	B42.00.1397.030.VP3001	X	X			40
5	JS9	5	5.01	2.7	B41.00.0501.020.VP3001	17		X	X	X
6		6	6.01	3.4	B41.00.0601.020.VP3001	17		X	X	X
8		8	8.01	4.1	B41.00.0801.020.VP3001		22	X	X	X
10		10	10.01	4.2	B42.00.1001.030.VP3001	X	X	30		
12		12	12.00	8.5	B42.00.1200.050.VP3001	X	X		38	
12		12	12.01	5.7	B42.00.1201.030.VP3001	X	X		38	
14		14	14.01	6.8	B42.00.1401.030.VP3001	X	X			40

### BROŞ UCU BİLGİ ALMA FORMU

BROACHING INSERT INFORMATION FORM

INFORMATIONSBLETT FÜR DIE WENDESCHNEIDPLATTE DER NUTBEARBEITUNG

Broş ve Delik Ölçüleri / Dimension of Bore / Maße von Bohrungsdurchmesser und Nuten

<b>b</b>		
<b>t</b>		
<b>r</b>		
<b>d/min*</b>		
<b>İş Parçası Malzemesi</b> Work Material Werkstückmaterial		
<b>Tolerans Grubu / Tolerane Group / Toleranzgruppe</b>		
<b>C11</b>	<b>P9</b>	<b>JS9</b>
		<b>CUSTOM</b>

# SUPAP

**SUPAP YUVASI İŞLEME UÇLARI ve TAKIMLARI**  
*VALVE SEAT INSERTS and TOOLHOLDERS*  
*WENDESCHNEIDPLATTEN UND WERKZEUGE FÜR*  
*VENTILSITZBEARBEITUNG*





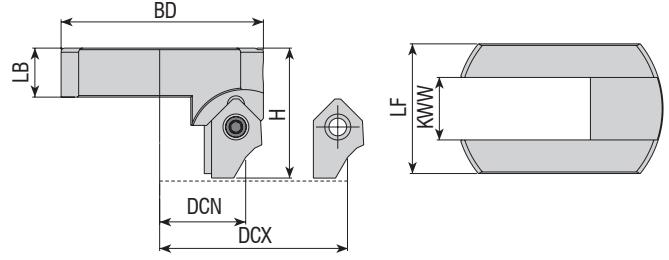

Takım Kodu Ordering Code Bestell-Bezeichnung	Stok Stock Lager	Takım Ölçüleri (mm) Dimension (mm) Abmessung (mm)						Kesici Uç Insert Wendeschneidplatte	Yedek Parçaları / Spare Parts / Ersatzteile				
		DCN DCX	BD	LB	H	KWW	LF		Sıkma Vidası Screw Schraube	Tork Anahtar Torx Key Torx-Schlüssel	Ayar Vidası Adjustable Einstellschraube	Anahtar Allen Key Innensechskantschlüssel	
VST-B11-2842	●	28-42	29	9.5	28.5	12	25.0						
VST-B11-4058	●	40-58	39	9.5	25.0	12	25.0	<b>B11...</b>	3008-M3x8	80-T08	2702-M4x10	AAL-01-02	

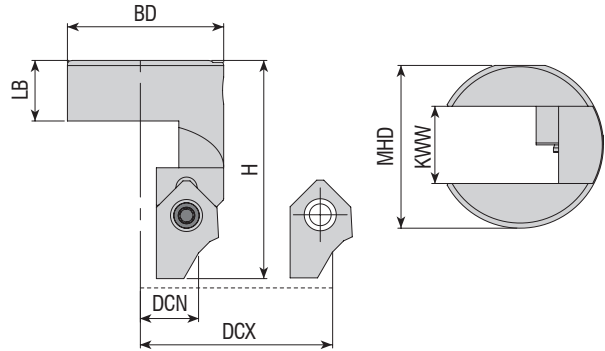

Takım Kodu Ordering Code Bestell-Bezeichnung	Stok Stock Lager	Takım Ölçüleri (mm) Dimension (mm) Abmessung (mm)						Kesici Uç Insert Wendeschneidplatte	Yedek Parçaları / Spare Parts / Ersatzteile				
		DCN DCX	BD	LB	H	KWW	MHD		Sıkma Vidası Screw Schraube	Tork Anahtar Torx Key Torx-Schlüssel	Ayar Vidası Adjustable Einstellschraube	Anahtar Allen Key Innensechskantschlüssel	
VST-B11-1830	●	18-30	24	9.5	34.0	12	25.3						

R: Sağ / Right / Rechts L: Sol/Left/Links

● Stokta / In Stock / Auf Lager ○ Stokta Yok / Non Stock Item / Kein Lagerartikel, Lieferzeit auf Anfrage

Sipariş Örneği/Ordering Example/Bestellbeispiel

1 ad./pcs./stück VST-B11-2842

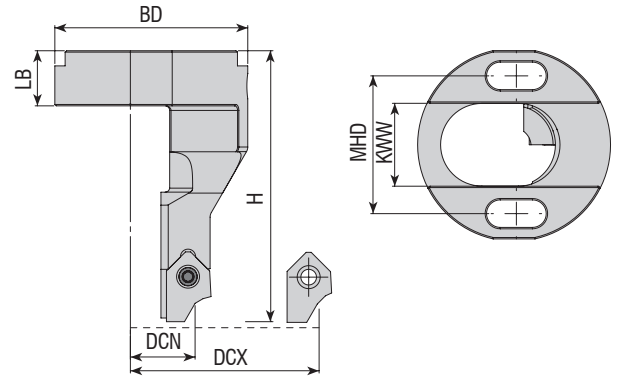

Takım Kodu Ordering Code Bestell-Bezeichnung	Stok Stock Lager	Takım Ölçüleri (mm) Dimension (mm) Abmessung (mm)						Yedek Parçaları / Spare Parts / Ersatzteile				
		DCN DCX	BD	LB	H	KWW	MHD	Kesici Uç Insert Wendeschneidplatte	Sıkma Vidası Screw Schraube	Tork Anahtar Torx Key Torx-Schlüssel	Ayar Vidası Adjustable Einstellschraube	Anahtar Allen Key Innensechskantschlüssel
VST-B11-2032	●	20-32	42	12	59	18	30	B11...	3008-M3x8	80-T08	2702-M4x10	AAL-01-02
VST-B11-2434	●	24-34	26	14	40	11	18.1					

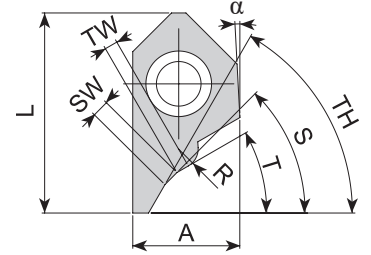
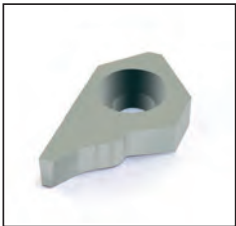

Uç Kodu Insert Code Wendeplatten-Bezeichnung	Stok Stock Lager	Uç Ölçüleri (mm) Insert Dimension (mm) Abmessung (mm)								
		S°	SW	T°	TW	TH°	A	L	α	R
B11013	●	45°	1.3	30°	1	60°	8.15	15.10	3°	1.50

R: Sağ / Right / Rechts L: Sol/Left/Links

● Stokta / In Stock / Auf Lager ○ Stokta Yok / Non Stock Item / Kein Lagerartikel, Lieferzeit auf Anfrage

Sipariş Örneği/Ordering Example/Bestellbeispiel

1 ad./pcs./stück VST-B11-2032



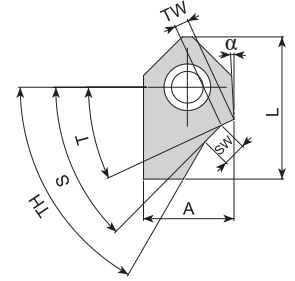
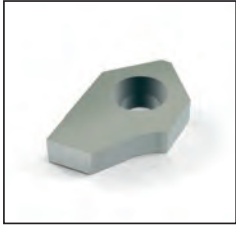

Uç Kodu Insert Code Wendepplatten-Bezeichnung	Stok Stock Lager	Uç Ölçüleri (mm) Insert Dimension (mm) Abmessung (mm)							
		S <sup>0</sup>	SW	T <sup>0</sup>	TW	TH <sup>0</sup>	A	L	α
B11003	●	45°	1.3	25°	1.1	52°	9.7	15.25	3°
B11004	●	45°	1.6	25°	1.3	52°	9.7	15.25	3°
B11005	●	45°	2	25°	1.3	52°	9.7	15.25	3°
B11006	●	45°	2.5	25°	1.5	52°	9.7	15.25	3°
B11007	●	45°	1.5	30°	1.5	60°	9.7	15.25	3°
B11008	●	45°	1.3	25°	1.1	60°	9.7	15.25	3°
B11009	●	45°	1.6	25°	1.3	60°	9.7	15.25	3°
B11010	●	45°	2	25°	1.3	60°	9.7	15.25	3°
B11011	●	30°	2	15°	1.8	60°	9.7	15.25	3°
B11012	●	36°	2	15°	1.6	60°	9.7	15.25	3°
B11014	●	45°	2.5	25°	1.5	60°	9.7	15.25	3°
B11016	●	30°	1.5	15°	1.3	60°	9.7	15.25	3°
B11017	●	30°	2.5	15°	1.8	60°	9.7	15.25	3°
B11018	●	36°	2.5	15°	1.6	60°	9.7	15.25	3°
B11019	●	20°	2.5	10°	2	75°	9.7	15.25	3°
B11020	●	45°	1.3	25°	1.1	52°	7.7	15.25	3°
B11021	●	30°	3	15°	1.8	60°	9.7	15.25	3°
B11022	●	45°	3	30°	1.8	60°	9.7	15.25	3°
B11029	●	40°	2.5	25°	1.5	60°	9.7	15.25	3°
B11030	●	20°	2	10°	1.3	60°	9.7	15.25	3°
B11031	●	45°	1.8	30°	1.3	60°	9.7	15.25	3°
B11032	●	45°	1.5	30°	1	52°	9.7	15.25	3°
B11033	●	45°	2	30°	1.1	52°	9.7	15.25	3°
B11034	●	45°	2.5	30°	1.3	52°	9.7	15.25	3°
B11035	●	30°	1.5	15°	1	45°	9.7	15.25	3°
B11036	●	30°	2	15°	1.1	45°	9.7	15.25	3°
B11037	●	30°	2.5	15°	1.3	45°	9.7	15.25	3°

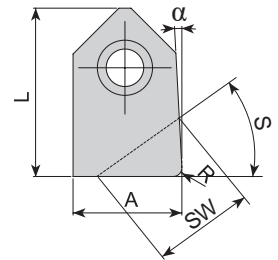
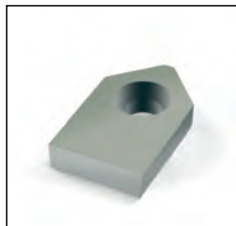

Uç Kodu Insert Code Wendepplatten-Bezeichnung	Stok Stock Lager	Uç Ölçüleri (mm) Insert Dimension (mm) Abmessung (mm)					
		S <sup>0</sup>	SW	A	L	α	R
B11015	●	0°	9.85	9.85	15.10	3°	0.80
B11023	●	0°	7.7	7.7	15.10	3°	0.80
B11024	●	20°	8.2	9.75	15.10	3°	-
B11025	●	25°	10	9.65	15.10	3°	-
B11026	●	30°	9	9.65	15.10	3°	-
B11027	●	35°	10	9.60	15.10	3°	-
B11028	●	45°	8.9	9.55	15.10	3°	-

R: Sağ / Right / Rechts L: Sol/Left/Links

● Stokta / In Stock / Auf Lager ○ Stokta Yok / Non Stock Item / Kein Lagerartikel, Lieferzeit auf Anfrage

Sipariş Örneği/Ordering Example/Bestellbeispiel

1 ad./pcs./stück B11003

# WHIRLING

WHIRLING UÇLARI ve TAKIMLARI



WHIRLING INSERTS and TOOLHOLDERS

WENDESCHNEIDPLATTEN UND WERKZEUGHALTER ZUM

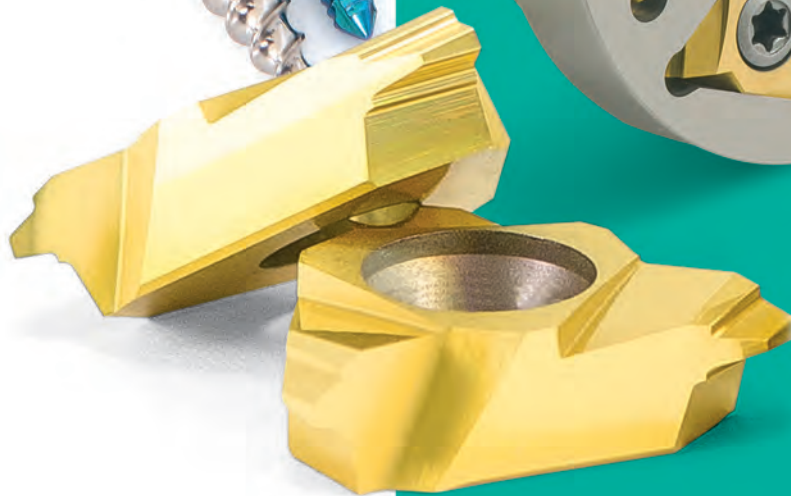
GEWINDEWIRBELN

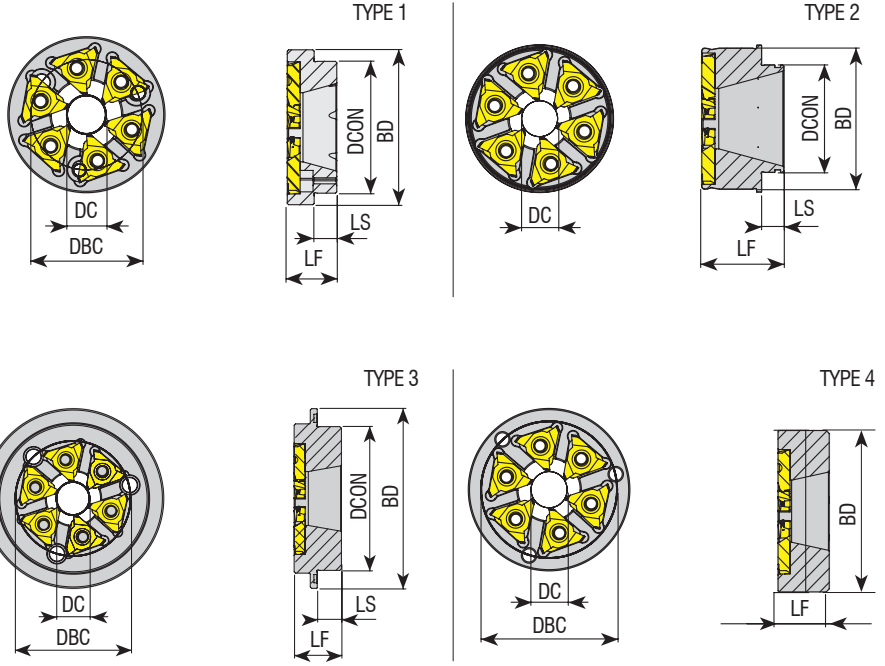



Makine Machine Maschine	Tahrikli Whirling Ünitesi Aggregate Whirling Unit Wirbelspindel	Whirling Ring Kodu Whirling Ring Code Wirbelring	Stok Stock Lager	Takım Ölçüleri (mm) Dimension (mm) Abmessung (mm)								Kesici Uç Insert Wendeschneidplatte	Yedek Parçaları / Spare Parts / Ersatzteile				
				ZEFP	DC	DCON	DBC	BD	LS	LF	TYPE		Sıkma Vidası Screw Schraube	Tork Anahtar Torx Key Torx-Schlüssel			
STAR	5914 72 00/68172	ATW-301-T09-D1240-Z06	●	6	12	40	33	47	7	15	1						
CITIZEN	BTW1000	ATW-302-T09-D1233-Z06	○	6	12	33	40	47	4	18.5	-						
	GSW101	ATW-303-T09-D0620-Z06	○	6	6	20	26	35	3.2	15	1						
	MWS101/KSW101	ATW-304-T09-D1240-Z06	○	6	12	40	32.5	46	2.5	15.5	1						
	LSW101/BSW215/ LSW215315																
	LSW424														ATW-305-T09-D1245-Z06	○	6
TORNOS	306101/307087	ATW-306-T09-D1240-Z06	●	6	12	40	31	57	3.5	15	-				T09....	4015 M4x11	80-T15
	417617	ATW-307-T09-D1250-Z06	○	6	12	50	40	67	3.5	15.4	-						
WTO	TN762004	ATW-308-T09-D1142-Z06	●	6	11	31.97	-	42	6.7	24.7	2						
	TN762006	ATW-309-T09-D2054-Z08	○	8	20	56.5	-	54	1.5	13.8	2						
TSUGAMI	3234 Y342	ATW-310-T09-D1252-Z06	●	6	12	52	42	65	8.7	17	3						
	3268 Y452	ATW-311-T09-D1252-Z06	○	6	12	52	44	52	10	10	3						
	3268 Y271	ATW-312-T09-D1252-Z06	○	6	12	52	38	54	6	19	3						
	3214 Y342	ATW-313-T09-D1650-Z06	○	6	16	50	40	62	8.5	20	3						
	3234 Y342	ATW-314-T09-D2052-Z06	○	6	20	52	42	65	8.7	17	3						
	3281-Y451	ATW-316-T09-D1252-Z06	●	6	12	52	44	52	-	17	4						
HANWHA	MADAULA	ATW-315-T09-D1245-Z06	○	6	12	45	-	56	8.5	15	1						

R: Sağ / Right / Rechts L: Sol/Left/Links

● Stokta / In Stock / Auf Lager ○ Stokta Yok / Non Stock Item / Kein Lagerartikel, Lieferzeit auf Anfrage

Sipariş Örneği/Ordering Example/Bestellbeispiel

1 ad./pcs./stück ATW-301-T09-D1240-Z06



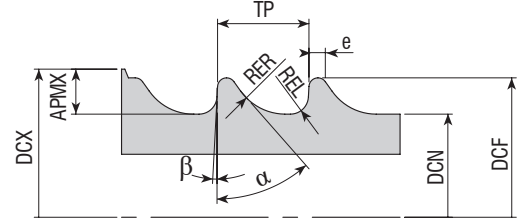
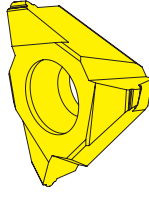
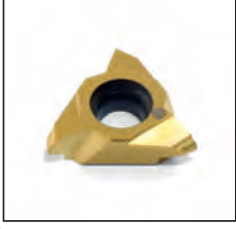

**Uç Kodu**  
**Insert Code**  
Wendeplatten-Bezeichnung

Kalite Grade Sorte	Standart ISO5835

**Uç Ölçüleri (mm)**  
Insert Dimension (mm)  
Abmessung (mm)

TP	e	DCF	DCN	RER	REL	$\alpha$	$\beta$	APMX	DCX			
T09.HA150.D12	● ●	HA1.5	0.5	0.1	1.35 to 1.5	1.0 to 1.1	0.30	0.1	35°	3°	4	9
T09.HA200.D12	● ●	HA2.0	0.6	0.1	1.85 to 2.0	1.2 to 1.3	0.40	0.1	35°	3°	4	9
T09.HA270.D12	● ●	HA2.7	1	0.1	2.55 to 2.7	1.75 to 1.9	0.60	0.2	35°	3°	4	9.5
T09.HA350.D12	● ●	HA3.5	1.25	0.1	3.35 to 3.5	2.25 to 2.4	0.80	0.2	35°	3°	4	10
T09.HA400.D12	● ●	HA4.0	1.5	0.1	3.85 to 4.0	2.75 to 2.9	0.80	0.2	35°	3°	4	10.5
T09.HA450.D12	● ●	HA4.5	1.75	0.1	4.35 to 4.5	2.85 to 3.0	1.00	0.3	35°	3°	4	11
T09.HA500.D12	● ●	HA5.0	1.75	0.1	4.85 to 5.0	3.35 to 3.5	1.00	0.3	35°	3°	4	11
T09.HB400.D12	● ●	HB4.0	1.75	0.1	3.85 to 4.0	1.75 to 1.9	0.80	0.3	25°	5°	4	9.5
T09.HB650.D12	● ●	HB6.5	2.75	0.2	6.35 to 6.5	2.85 to 3.0	1.20	0.8	25°	5°	4	11

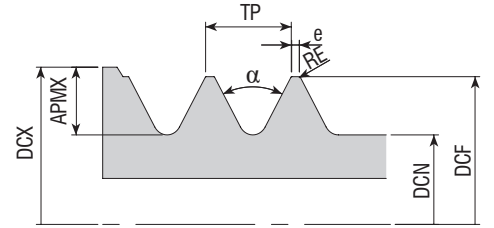
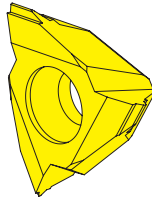
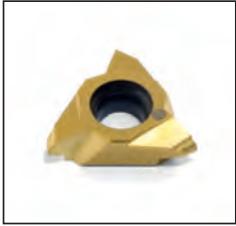

**Uç Kodu**  
**Insert Code**  
Wendeplatten-Bezeichnung

Kalite Grade Sorte	Standart ISO9268

**Uç Ölçüleri (mm)**  
Insert Dimension (mm)  
Abmessung (mm)

TP	e	DCF	DCN	$\alpha$	RE	APMX	DCX			
T09.HC290.D12	○ ○	HC2.9	1.06	0.1	2.79 to 2.90	2.03 to 2.18	60°	0.01	4	10.5
T09.HC350.D12	○ ○	HC3.5	1.27	0.1	3.43 to 3.53	2.51 to 2.64	60°	0.01	4	11
T09.HC390.D12	○ ○	HC3.9	1.27	0.1	3.78 to 3.91	2.77 to 2.92	60°	0.01	4	11.5
T09.HC420.D12	○ ○	HC4.2	1.27	0.1	4.09 to 4.22	2.95 to 3.25	60°	0.01	4	12

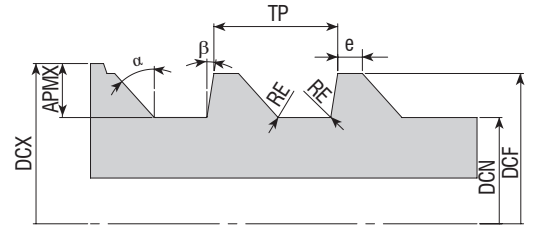
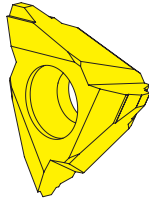
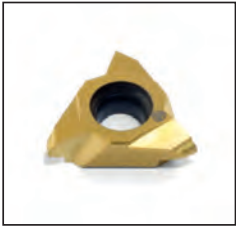

**Uç Kodu**  
**Insert Code**  
Wendeplatten-Bezeichnung

Kalite Grade Sorte	Standart ISO9268

**Uç Ölçüleri (mm)**  
Insert Dimension (mm)  
Abmessung (mm)

TP	e	DCF	DCN	RE	$\alpha$	$\beta$	APMX	DCX			
T09.HD400.D12	○ ○	HD4.0	1.59	0.1	3.97 to 4.03	2.89 to 2.95	0.01	45°	10°	4	11.5
T09.HD450.D12	○ ○	HD4.5	2.18	0.1	4.47 to 4.53	2.89 to 2.95	0.01	45°	10°	4	12

R: Sağ / Right / Rechts L: Sol/Left/Links  
● Stokta / In Stock / Auf Lager ○ Stokta Yok / Non Stock Item / Kein Lagerartikel, Lieferzeit auf Anfrage

Sipariş Örneği/Ordering Example/Bestellbeispiel  
1 ad./pcs./stück T09.HA150.D12

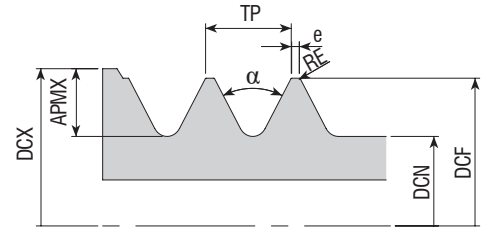
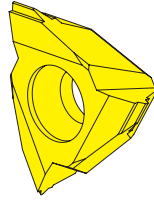
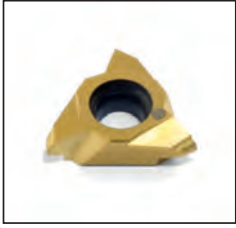

Uç Kodu Insert Code Wendepplatten-Bezeichnung	Kalite Grade Sorte		Standart DIN13	Uç Ölçüleri (mm) Insert Dimension (mm) Abmessung (mm)						
	VK15U	VK15U01		TP	DCF	DCN	a	RE	APMX	DCX
T09.M200.D12	●	●	M2	0.4	2	1.509	60	0.048	4	9
T09.M250.D12	●	●	M2.5	0.45	2.5	1.928	60	0.055	4	9.5
T09.M300.D12	●	●	M3	0.5	3	2.387	60	0.062	4	10
T09.M350.D12	●	●	M3.5	0.6	3.5	2.744	60	0.077	4	8.5
T09.M400.D12	●	●	M4.0	0.7	4	3.141	60	0.091	4	11
T09.M500.D12	●	●	M5.0	0.8	5	4.019	60	0.105	4	11.5
T09.M600.D12	●	●	M6.0	1	6	4.773	60	0.134	4	12.5
T09.M700.D12	●	●	M7.0	1	7	5.753	60	0.134	4	13.5
T09.M800.D12	●	●	M8.0	1.25	8	6.446	60	0.17	4	14

Kesme başlangıç pozisyonu  
Cutting Start Position  
Startposition Schneidvorgang

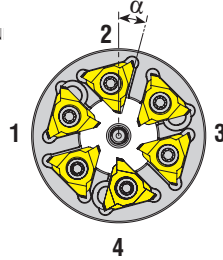

Y Eksen  
Y Axis  
Y-Achse

İş parçası dönüş yönü  
Turning Direction of Workpiece  
Drehrichtung Werkstück



Whirling ünitesi dönüş yönü  
Turning Direction of Whirling unit  
Drehrichtung Gewindewirbel  
Werkzeug

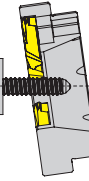

Makine Özellikleri Machine Specifications Angaben zur Maschine		Malzeme Özellikleri Material Specifications Material Besonderheiten	
<b>Makine Üreticisi</b> Machine Manufacturer Maschinenhersteller		<b>Malzeme (DIN, AISI v.b.)</b> Material (DIN, AISI etc.) Material DIN, AISI etc.	
<b>Makine Modeli</b> Machine Model Maschinenbezeichnung		<b>Ham Malzeme Çapı</b> Raw Material Diameter Rohmaterial Durchmesser	
<b>Tahrikli Whirling Ünitesi Üreticisi</b> Live Tool Manufacturer Hersteller angetriebene Werkzeuge		<b>Diş Profili</b> Thread Profile Gewindeprofil	
<b>Tahrikli Whirling Ünitesi</b> Aggregate Whirling Unit Wirbelspindel		<b>Profil Teknik Resmi</b> Profile Technical Drawing Profilzeichnung	
<b>Y - Eksen</b> Y - Axis Y - Achse	<b>Var</b> Exist Ja <input type="checkbox"/>	<b>Yok</b> None Nein <input type="checkbox"/>	<b>Hatve</b> Pitch Steigung
<b>Yüksek Basınçlı Soğutma</b> High Pressure Coolant Hochdruckkühlung	<b>Var</b> Exist Ja <input type="checkbox"/>	<b>Yok</b> None Nein <input type="checkbox"/>	<b>Tek Ağız</b> One Start Eingängig
<b>Kesme Başlangıç Pozisyonu</b> Cutting Start Position Startposition Schneidvorgang	1 <input type="checkbox"/> 2 <input type="checkbox"/> 3 <input type="checkbox"/> 4 <input type="checkbox"/>		<b>İki Ağız</b> Two Starts Zweigängig
<b>Whirling Ünitesi Dönüş Yönü</b> Turning Direction of Whirling Unit Drehrichtung Gewindewirbel-Werkzeug	5 <input type="checkbox"/> 6 <input type="checkbox"/>		<b>Müşteri Adı / Customer Name / Kundenname:</b>
<b>İş Parçası Dönüş Yönü</b> Turning Direction of Workpiece Drehrichtung Werkstück	7 <input type="checkbox"/> 8 <input type="checkbox"/>		<b>Yetkili / Responsible Person / Ansprechpartner :</b>
<b>α Açısı</b> α Angle α Winkel	<b>Not: Bu açı ürün performansına etki ettiğinden bildirilmesi gerekmektedir. Aksi halinde ring tarafımıza gönderilmelidir.</b> Note: This angle effects the performance of inserts. If doesn't known, tool body should be send to AKKO. Hinweis: Dieser Winkel beeinflusst die Leistung der Wendeschneidplatte. Sollte dieser Winkel unbekannt sein, können Sie das Werkzeug zur Fa. AKKO schicken.		
<b>Not / Note / Notizen :</b>			

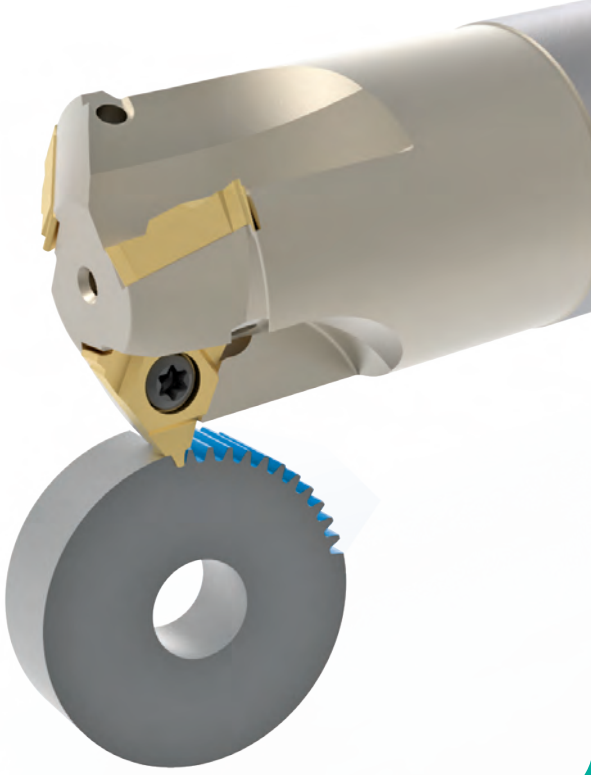



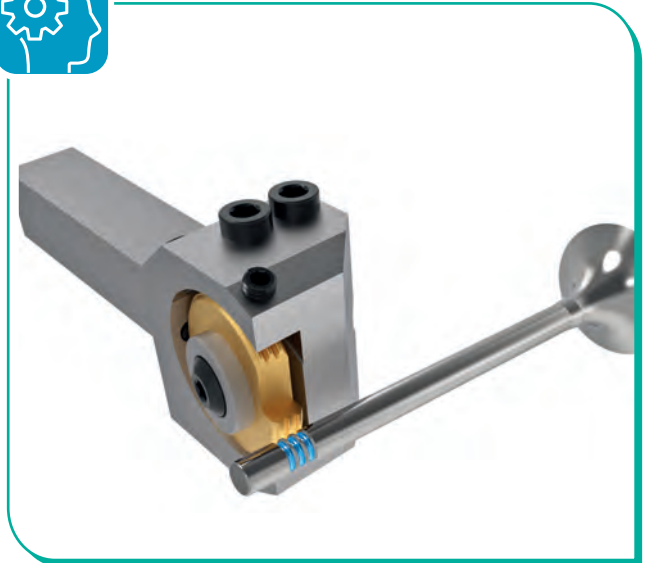
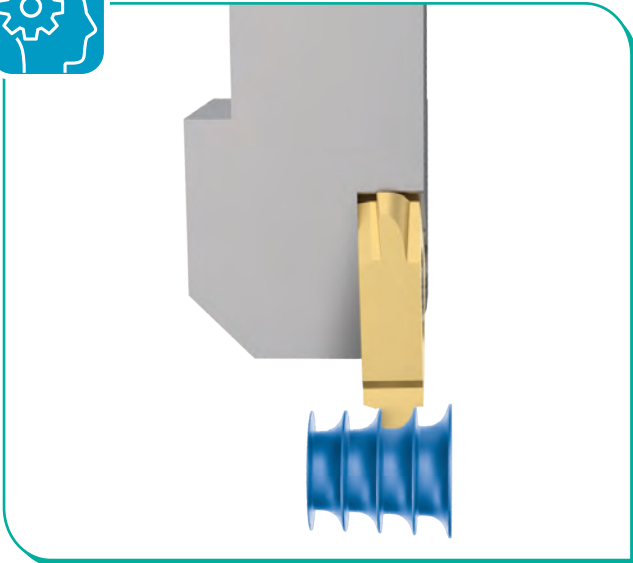
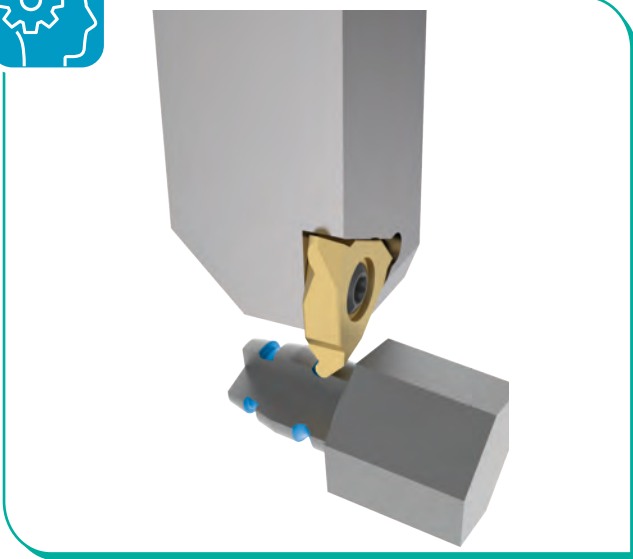
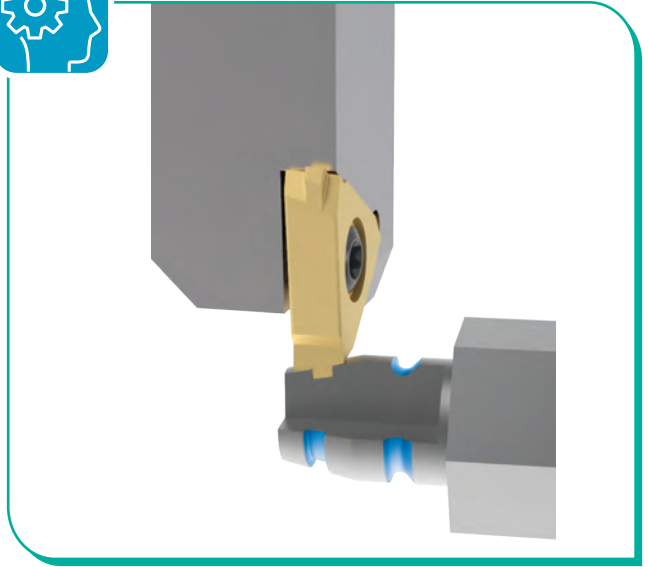
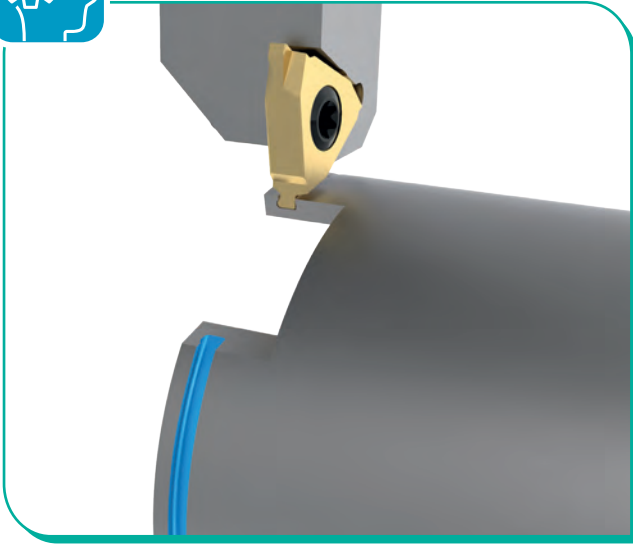



**DIŞ TORNA TAKIMLARI**  
*EXTERNAL TURNING TOOLHOLDERS*  
*DREHEN - AUßENDREHHALTER*





**P** **S** **K** **N** **R**

1 2 3 4 5

**1** Sıkma Tipi / Method of Mounting of Insert / Klemmsystem

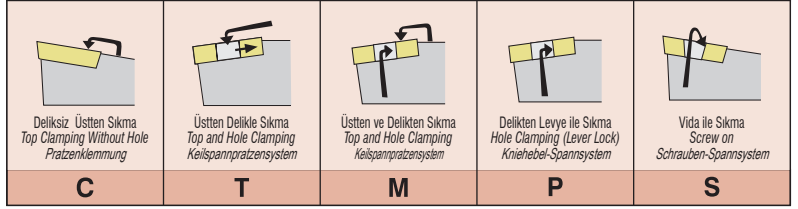

**2** Uç Tipi / Type of Insert / Plattenform

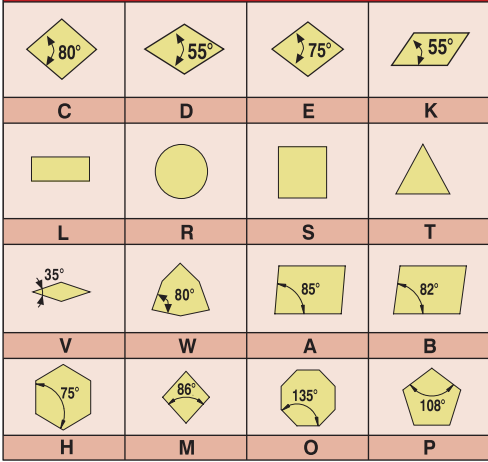

**3** Yanaşma Açısı / Tool Holder Shape Bar Geometry / Anstellwinkel

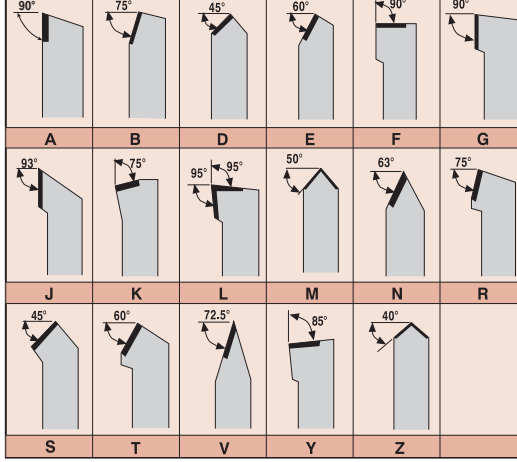

**4** Serbest Uç Açısı / Insert Clearance Angle / Freiwinkel / Freiwinkel

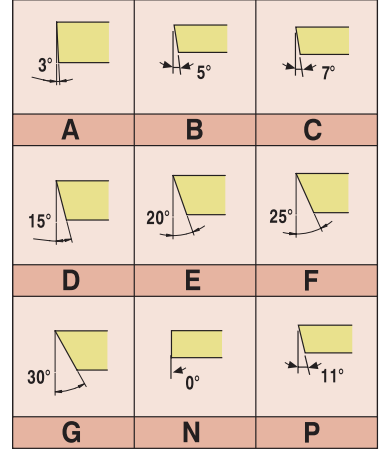

**25** **25 -** **M** **12** **C**

6 7 8 9 10

**5** Kesme Yönü / Cutting Direction / Halterausführung

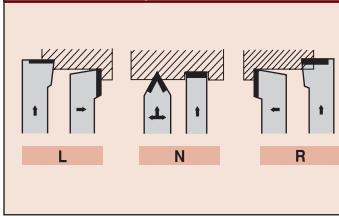

**6** Kesme Kenar Yüksekliği / Cutting Edge Height / Schaffhöhe

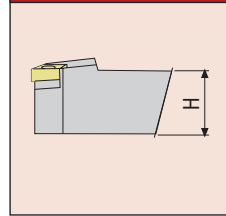

**7** Şaft Geniştirliği / Shank Width / Schaffbreite

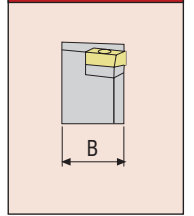

**8** Şaft Boyu / Shank Length / Schaftlänge

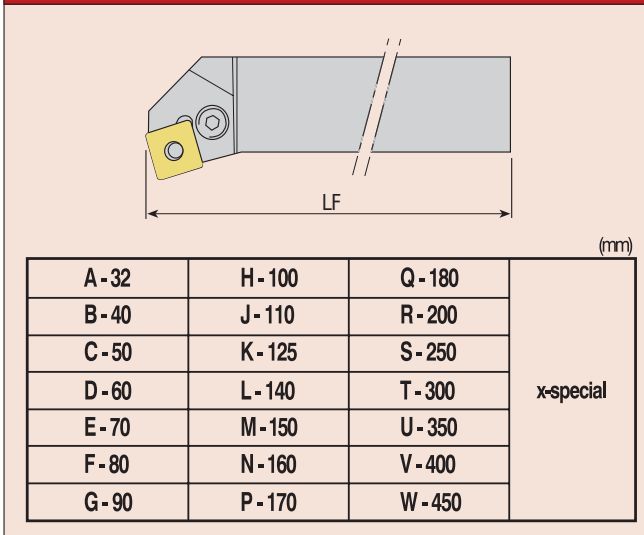

**9** Kesme Kenar Uzunluğu / Cutting Edge Length / Schneidkantenlänge

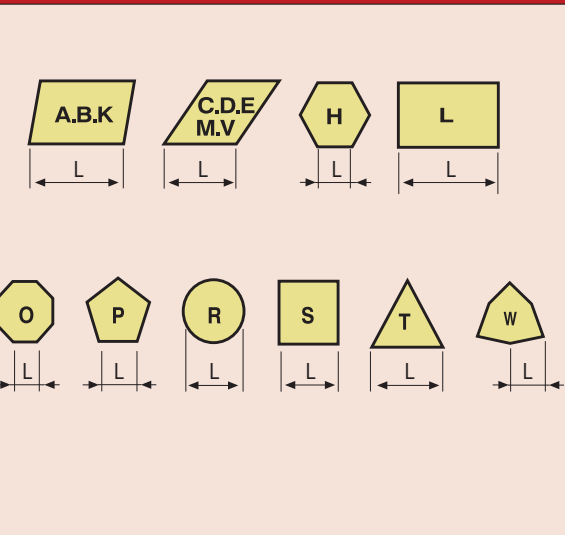

**10** Baskı Pabucu / Wedge Clamp / Spannpratze

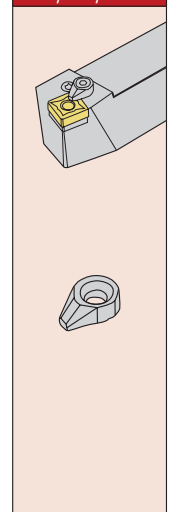





*konusulan  
the spoken kalite...  
quality...*

## T-SİSTEM

**T-SİSTEM DIŞ TORNA KATERLERİ**  
T-SYSTEM EXTERNAL TURNING TOOLHOLDERS  
T-SYSTEM AUSSEN - DREHHALTER MIT INNENKÜHLUNG



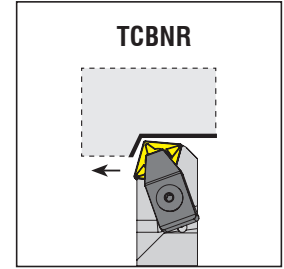
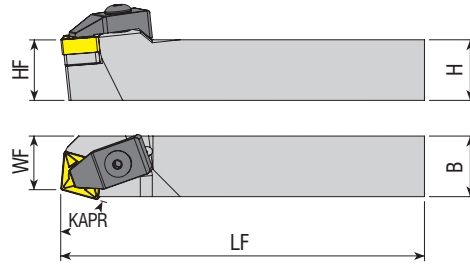

Takım Kodu Ordering Code Bestell-Bezeichnung	Stok Stock Lager		Takım Ölçüleri (mm) Dimension (mm) Abmessung (mm)				Kesici Uç Insert Wendescheidplatte	Baskı Pabuçu Wedge Clamp Spannpratze	Pabuç Vidası Clamp Screw Klemmschraube	Altlık Shim Unterlage	Altlık Vidası Shim Screw Schraube für Unterlage	Sekman Ring Feder	Pul Stamp Ring	Anahtar Allen Key Innerschlüsselschlüssel
	R	L	HF=H	B	LF	WF								
	Yedek Parçaları / Spare Parts / Ersatzteile													
<b>TCBNR/L 2525 M16</b>	●	●	25	25	150	22	<b>CNM. 1606..</b>	ATK-04	AKV-19-M7x25	AACN-3-0002	AAV-05-M6x15	AS-02	ABPL-02	AAL-05-4

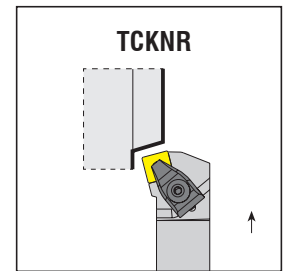
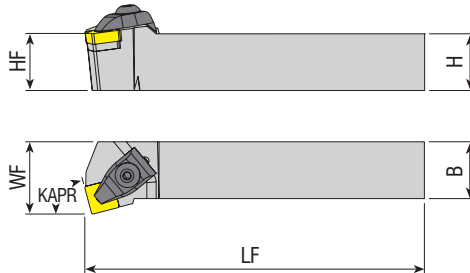
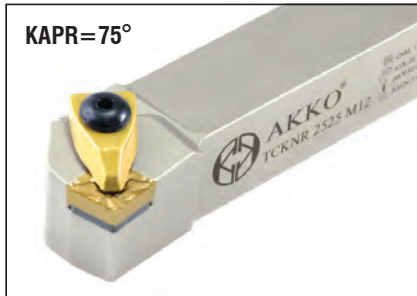

Takım Kodu Ordering Code Bestell-Bezeichnung	Stok Stock Lager		Takım Ölçüleri (mm) Dimension (mm) Abmessung (mm)				Kesici Uç Insert Wendescheidplatte	Baskı Pabuçu Wedge Clamp Spannpratze	Pabuç Vidası Clamp Screw Klemmschraube	Altlık Shim Unterlage	Altlık Vidası Shim Screw Schraube für Unterlage	Sekman Ring Feder	Pul Stamp Ring	Anahtar Allen Key Innerschlüsselschlüssel
	R	L	HF=H	B	LF	WF								
	Yedek Parçaları / Spare Parts / Ersatzteile													
<b>TCKNR/L 2020 K12</b>	●	●	20	20	125	25	<b>CNM. 1204..</b>	ATK-02	AKV-30-M6x22	AACN-3-0001	AAV-02-M5x12	AS-01	ABPL-01	AAL-03-3
<b>2525 M12</b>	●	●	25	25	150	32								
<b>3232 P12</b>	●	●	32	32	170	40								
<b>2525 M16</b>	●	●	25	25	150	32	<b>CNM. 1606..</b>	ATK-04	AKV-19-M7x25	AACN-3-0002	AAV-05-M6x15	AS-02	ABPL-02	AAL-05-4
<b>3232 P16</b>	●	●	32	32	170	40								

R: Sağ / Right / Rechts L: Sol/Left/Links

● Stokta / In Stock / Auf Lager ○ Stokta Yok / Non Stock Item / Kein Lagerartikel, Lieferzeit auf Anfrage

Sipariş Örneği/Ordering Example/Bestellbeispiel

1 ad./pcs./stück TCBNR 2525 M16

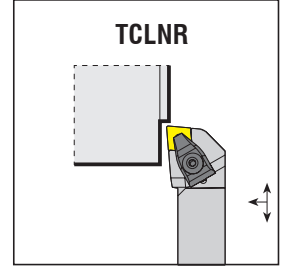
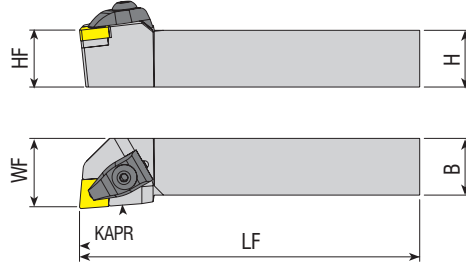

Takım Kodu Ordering Code Bestell-Bezeichnung	Stok Stock Lager		Takım Ölçüleri (mm) Dimension (mm) Abmessung (mm)				Kesici Uç Insert Wendeschneidplatte	Yedek Parçaları / Spare Parts / Ersatzteile						
	R	L	HF=H	B	LF	WF		Baskı Pabucu Wedge Clamp Spannpratze	Pabuç Vidası Clamp Screw Klemmschraube	Altlık Shim Unterlage	Altlık Vidası Shim Screw Schraube für Unterlage	Sekman Ring Feder	Pul Stamp Ring	Anahtar Allen Key Immerschlüsselschlüssel
<b>TCLNR/L 2020 K12</b>	●	●	20	20	125	25	<b>CNM. 1204..</b>							
<b>2525 M12</b>	●	●	25	25	150	32								
<b>3232 P12</b>	●	●	32	32	170	40								
<b>4040 S12</b>	●	●	40	40	250	50								
<b>5050 S12</b>	●	●	50	50	250	63	<b>CNM. 1606..</b>							
<b>2525 M16</b>	●	●	25	25	150	32								
<b>3232 P16</b>	●	●	32	32	170	40								

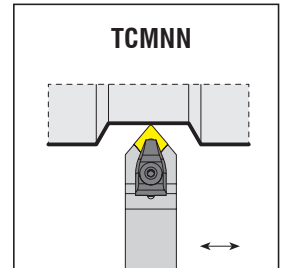
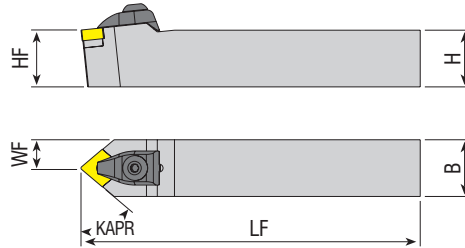

Takım Kodu Ordering Code Bestell-Bezeichnung	Stok Stock Lager		Takım Ölçüleri (mm) Dimension (mm) Abmessung (mm)				Kesici Uç Insert Wendeschneidplatte	Yedek Parçaları / Spare Parts / Ersatzteile						
	R	L	HF=H	B	LF	WF		Baskı Pabucu Wedge Clamp Spannpratze	Pabuç Vidası Clamp Screw Klemmschraube	Altlık Shim Unterlage	Altlık Vidası Shim Screw Schraube für Unterlage	Sekman Ring Feder	Pul Stamp Ring	Anahtar Allen Key Immerschlüsselschlüssel
<b>TCMNN 1616 H12</b>	●		16	16	100	8	<b>CNM. 1204..</b>							
<b>2020 K12</b>	●		20	20	125	10								
<b>2525 M12</b>	●		25	25	150	12.5								
<b>3232 P12</b>	●		32	32	170	16								
<b>2525 M16</b>	●		25	25	150	12.5	<b>CNM. 1606..</b>							
<b>3232 P16</b>	●		32	32	170	16								
<b>4040 S16</b>	○		40	40	250	20								

R: Sağ / Right / Rechts L: Sol/Left/Links

● Stokta / In Stock / Auf Lager ○ Stokta Yok / Non Stock Item / Kein Lagerartikel, Lieferzeit auf Anfrage

Sipariş Örneği/Ordering Example/Bestellbeispiel

1 ad./pcs./stück TCLNR 2020 K12



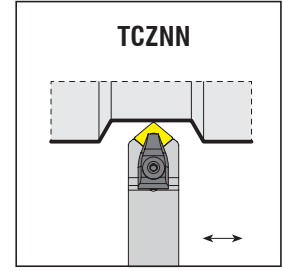
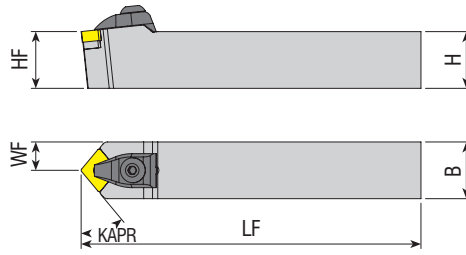
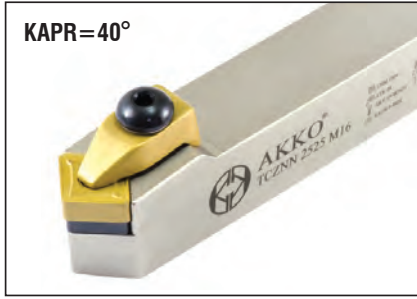

Takım Kodu Ordering Code Bestell-Bezeichnung	Stok Stock Lager		Takım Ölçüleri (mm) Dimension (mm) Abmessung (mm)				Kesici Uç Insert Wendeschneidplatte	Yedek Parçaları / Spare Parts / Ersatzteile														
	R	L	HF=H	B	LF	WF		Baskı Pabucu Wedge Clamp Spannpratze	Pabuç Vidası Clamp Screw Klemmschraube	Altlık Shim Unterlage	Altlık Vidası Shim Screw Schraube für Unterlage	Sekman Ring Feder	Pul Stamp Ring	Anahtar Allen Key Innensechskantschlüssel								
<b>TCZNN 2020 K12</b>	●		20	20	125	10																
<b>2525 M12</b>	●		25	25	150	12.5									<b>CNM. 1204..</b>	ATK-02	AKV-30-M6x22	AACN-3-0001	AAV-02-M5x12	AS-01	ABPL-01	AAL-03-3
<b>3232 P12</b>	●		32	32	170	16																
<b>2525 M16</b>	●		25	25	150	12.5	<b>CNM. 1606..</b>	ATK-04	AKV-19-M7x25	AACN-3-0002	AAV-05-M6x15	AS-02	ABPL-02	AAL-05-4								
<b>3232 P16</b>	●		32	32	170	16																

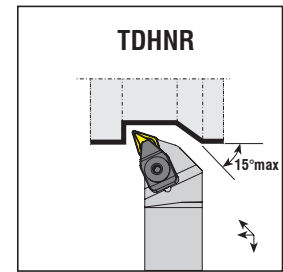
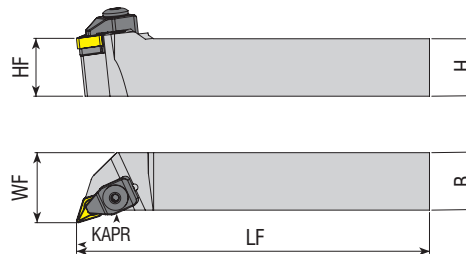

Takım Kodu Ordering Code Bestell-Bezeichnung	Stok Stock Lager		Takım Ölçüleri (mm) Dimension (mm) Abmessung (mm)				Kesici Uç Insert Wendeschneidplatte	Yedek Parçaları / Spare Parts / Ersatzteile								
	R	L	HF=H	B	LF	WF		Baskı Pabucu Wedge Clamp Spannpratze	Pabuç Vidası Clamp Screw Klemmschraube	Altlık Shim Unterlage	Altlık Vidası Shim Screw Schraube für Unterlage	Sekman Ring Feder	Pul Stamp Ring	Anahtar Allen Key Innensechskantschlüssel		
<b>TDHNR/L 2525 M11</b>	○	●	25	25	150	31										
<b>2020 K15</b>	●	●	20	20	125	25									<b>DNM. 1104..</b>	vATK-01
<b>2525 M15</b>	●	●	25	25	150	32	<b>DNM. 1506..</b>	ATK-02	AKV-30-M6x22	AADN-3-0001	AAV-02-M5x12	AS-01	ABPL-01	AAL-03-3		
<b>3232 P15</b>	●	●	32	32	170	40										

R: Sağ / Right / Rechts L: Sol/Left/Links

● Stokta / In Stock / Auf Lager ○ Stokta Yok / Non Stock Item / Kein Lagerartikel, Lieferzeit auf Anfrage

Sipariş Örneği/Ordering Example/Bestellbeispiel

1 ad./pcs./stück TCZNN 2020 K12

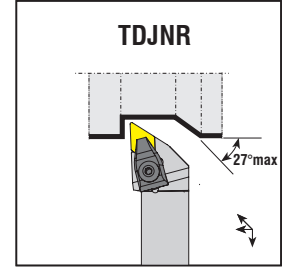
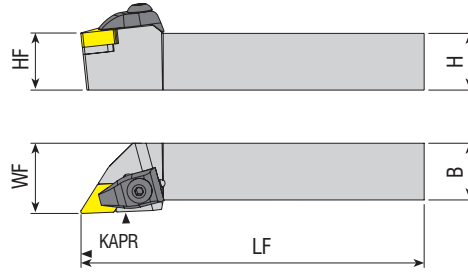

Takım Kodu Ordering Code Bestell-Bezeichnung	Stok Stock Lager		Takım Ölçüleri (mm) Dimension (mm) Abmessung (mm)				Kesici Uç Insert Wendeschneidplatte	Yedek Parçaları / Spare Parts / Ersatzteile						
	R	L	HF=H	B	LF	WF		Baskı Pabuçu Wedge Clamp Spannpratze	Pabuç Vidası Clamp Screw Klemmschraube	Altlık Shim Unterlage	Altlık Vidası Shim Screw Schraube für Unterlage	Sekman Ring Feder	Pul Stamp Ring	Anahtar Allen Key Innerschlüsselschlüssel
	●	○												
<b>TDJNR/L 1616 H11</b>	●	●	16	16	100	20	<b>DNM. 1104..</b>	ATK-01	AKV-01-M5x22	AADN-2-0001	AAV-04-M5x12	-	ABPL-01	AAL-03-3
<b>2020 K11</b>	●	●	20	20	125	25								
<b>2525 M11</b>	●	●	25	25	150	32								
<b>2020 K15</b>	●	●	20	20	125	25	<b>DNM. 1506..</b>	ATK-02	AKV-30-M6x22	AADN-3-0001	AAV-02-M5x12	AS-01	ABPL-01	AAL-03-3
<b>2525 M15</b>	●	●	25	25	150	32								
<b>3232 P15</b>	●	●	32	32	170	40								
<b>4040 S15</b>	●	●	40	40	250	50								
<b>5050 S15</b>	○	○	50	50	250	63	<b>DNM. 1504..</b>	ATK-02	AKV-30-M6x22	AADN-2-0003	AAV-02-M5x12	AS-01	ABPL-01	AAL-03-3
<b>2020 K1504</b>	●	●	20	20	125	25								
<b>2525 M1504</b>	●	●	25	25	150	32								
<b>3232 P1504</b>	●	●	32	32	170	40								
<b>4040 S1504</b>	●	●	40	40	250	50								

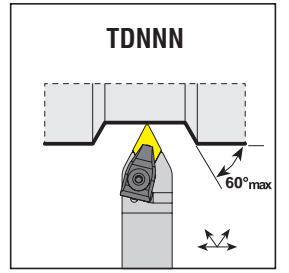
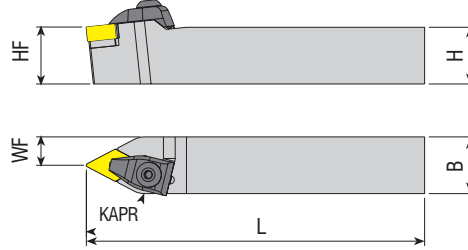
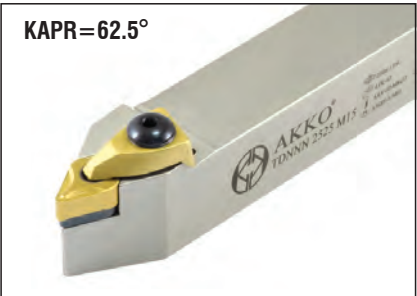

Takım Kodu Ordering Code Bestell-Bezeichnung	Stok Stock Lager		Takım Ölçüleri (mm) Dimension (mm) Abmessung (mm)				Kesici Uç Insert Wendeschneidplatte	Yedek Parçaları / Spare Parts / Ersatzteile						
	R	L	HF=H	B	LF	WF		Baskı Pabuçu Wedge Clamp Spannpratze	Pabuç Vidası Clamp Screw Klemmschraube	Altlık Shim Unterlage	Altlık Vidası Shim Screw Schraube für Unterlage	Sekman Ring Feder	Pul Stamp Ring	Anahtar Allen Key Innerschlüsselschlüssel
	●	○												
<b>TDNNN 1616 H11</b>	●	●	16	16	100	8	<b>DNM. 1104..</b>	ATK-01	AKV-01-M5x22	AADN-2-0001	AAV-04-M5x12	-	ABPL-01	AAL-03-3
<b>2020 K11</b>	●	●	20	20	125	10								
<b>2525 M11</b>	●	●	25	25	150	12.5								
<b>2020 K15</b>	●	●	20	20	125	10	<b>DNM. 1506..</b>	ATK-02	AKV-30-M6x22	AADN-3-0001	AAV-02-M5x12	AS-01	ABPL-01	AAL-03-3
<b>2525 M15</b>	●	●	25	25	150	12.5								
<b>3232 P15</b>	●	●	32	32	170	16								
<b>4040 S15</b>	○	○	40	40	250	20								
<b>5050 S15</b>	○	○	50	50	250	25								

R: Sağ / Right / Rechts L: Sol/Left/Links

● Stokta / In Stock / Auf Lager ○ Stokta Yok / Non Stock Item / Kein Lagerartikel, Lieferzeit auf Anfrage

Sipariş Örneği/Ordering Example/Bestellbeispiel

1 ad./pcs./stück TDJNR 1616 H11

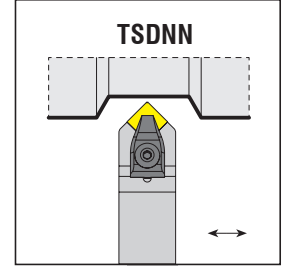
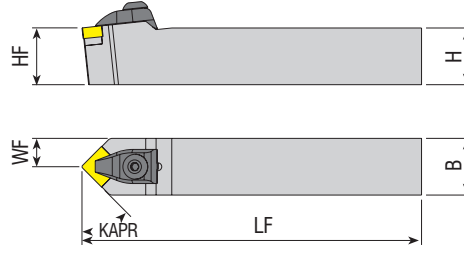

Takım Kodu Ordering Code Bestell-Bezeichnung	Stok Stock Lager		Takım Ölçüleri (mm) Dimension (mm) Abmessung (mm)				Kesici Uç Insert Wendescheidplatte	Yedek Parçaları / Spare Parts / Ersatzteile								
	R	L	HF=H	B	LF	WF		Baskı Pabucu Wedge Clamp Spannpratze	Pabuç Vidası Clamp Screw Klemmschraube	Altlık Shim Unterlage	Altlık Vidası Shim Screw Schraube für Unterlage	Sekman Ring Feder	Pul Stamp Ring	Anahtar Allen Key Innensechskantschlüssel		
<b>TSDNN 1616 H12</b>	●		16	16	100	8	<b>SNM. 1204..</b>									
<b>2020 K12</b>	●		20	20	125	10										
<b>2525 M12</b>	●		25	25	150	12.5										
<b>3232 P12</b>	●		32	32	170	16										
<b>2525 M15</b>	○		25	25	150	12.5	<b>SNM. 1506..</b>									
<b>3232 P15</b>	●		32	32	170	16										
<b>4040 S15</b>	○		40	40	250	20										

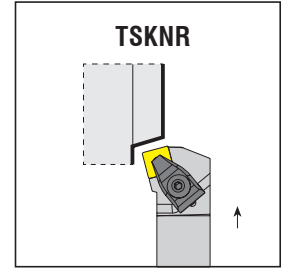
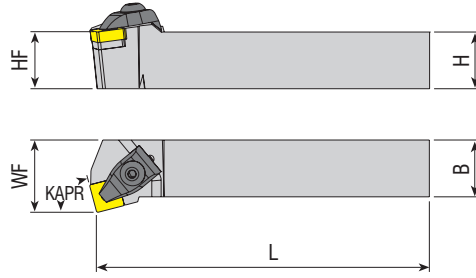

Takım Kodu Ordering Code Bestell-Bezeichnung	Stok Stock Lager		Takım Ölçüleri (mm) Dimension (mm) Abmessung (mm)				Kesici Uç Insert Wendescheidplatte	Yedek Parçaları / Spare Parts / Ersatzteile								
	R	L	HF=H	B	LF	WF		Baskı Pabucu Wedge Clamp Spannpratze	Pabuç Vidası Clamp Screw Klemmschraube	Altlık Shim Unterlage	Altlık Vidası Shim Screw Schraube für Unterlage	Sekman Ring Feder	Pul Stamp Ring	Anahtar Allen Key Innensechskantschlüssel		
<b>TSKNR/L 2020 K12</b>	●	●	20	20	125	25	<b>SNM. 1204..</b>									
<b>2525 M12</b>	●	●	25	25	150	32										
<b>3232 P12</b>	●	●	32	32	170	40										
<b>3232 P15</b>	●	●	32	32	170	40	<b>SNM. 1506..</b>									

R: Sağ / Right / Rechts L: Sol/Left/Links

● Stokta / In Stock / Auf Lager ○ Stokta Yok / Non Stock Item / Kein Lagerartikel, Lieferzeit auf Anfrage

Sipariş Örneği/Ordering Example/Bestellbeispiel

1 ad./pcs./stück TSDNN 1616 H12



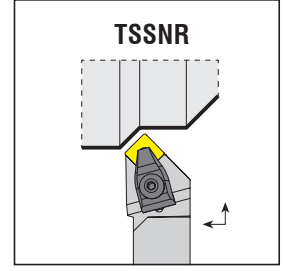
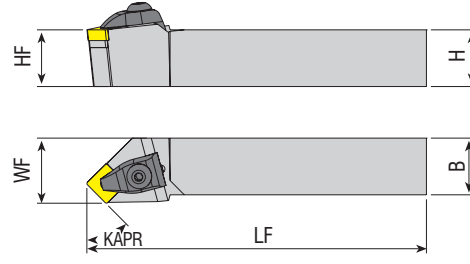

Takım Kodu Ordering Code Bestell-Bezeichnung	Stok Stock Lager		Takım Ölçüleri (mm) Dimension (mm) Abmessung (mm)				Kesici Uç Insert Wendeschneidplatte	Yedek Parçaları / Spare Parts / Ersatzteile						
	R	L	HF=H	B	LF	WF		Baskı Pabucu Wedge Clamp Spannpratze	Pabuç Vidası Clamp Screw Klemmschraube	Altlık Shim Unterlage	Altlık Vidası Shim Screw Schraube für Unterlage	Sekman Ring Feder	Pul Stamp Ring	Anahtar Allen Key Innerschloßschlüssel
<b>TSSNR/L 2020 K12</b>	●	●	20	20	125	25	SNM. 1204..	ATK-02	AKV-30-M6x22	AASN-3-0004	AAV-02-M5x12	AS-01	ABPL-01	AAL-03-3
<b>2525 M12</b>	●	●	25	25	150	32								
<b>3232 P12</b>	●	●	32	32	170	40								
<b>2525 M15</b>	●	●	25	25	150	32	SNM. 1506..	ATK-04	AKV-19-M7x25	AASN-3-0023	AAV-05-M6x15	AS-02	ABPL-02	AAL-05-4
<b>3232 P15</b>	●	●	32	32	170	40								

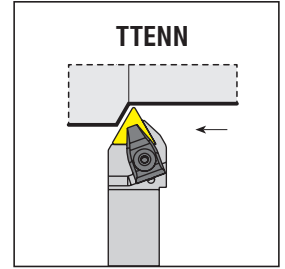
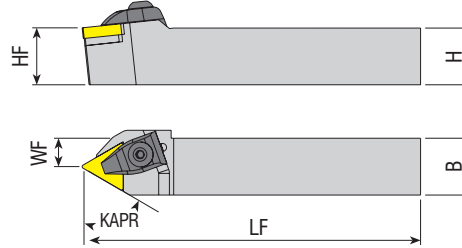

Takım Kodu Ordering Code Bestell-Bezeichnung	Stok Stock Lager		Takım Ölçüleri (mm) Dimension (mm) Abmessung (mm)				Kesici Uç Insert Wendeschneidplatte	Yedek Parçaları / Spare Parts / Ersatzteile						
			HF=H	B	LF	WF		Baskı Pabucu Wedge Clamp Spannpratze	Pabuç Vidası Clamp Screw Klemmschraube	Altlık Shim Unterlage	Altlık Vidası Shim Screw Schraube für Unterlage	Sekman Ring Feder	Pul Stamp Ring	Anahtar Allen Key Innerschloßschlüssel
<b>TTENN 2020 K16</b>	●		20	20	125	10	TNM. 1604..	ATK-01	AKV-01-M5x22	AATN-2-0002	AAV-03-M5x12	-	ABPL-01	AAL-03-3
<b>2525 M16</b>	●		25	25	150	12.5								
<b>3232 P16</b>	●		32	32	170	16								
<b>2525 M22</b>	●		25	25	150	12.5	TNM. 2204..	ATK-02	AKV-30-M6x22	AATN-3-0015	AAV-02-M5x12	AS-01		
<b>3232 P22</b>	●		32	32	170	16								
<b>4040 S22</b>	○		40	40	250	20								

R: Sağ / Right / Rechts L: Sol/Left/Links  
● Stokta / In Stock / Auf Lager ○ Stokta Yok / Non Stock Item / Kein Lagerartikel, Lieferzeit auf Anfrage

Sipariş Örneği/Ordering Example/Bestellbeispiel  
1 ad./pcs./stück TSSNR 2020 K12

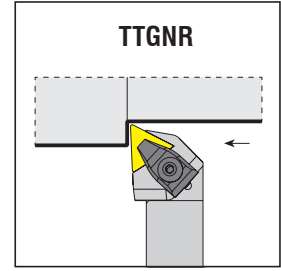
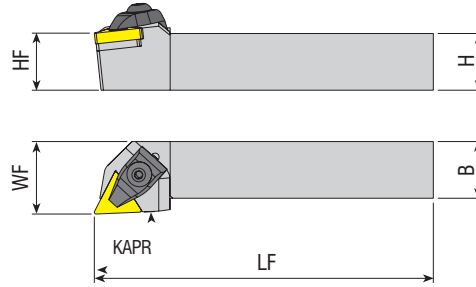
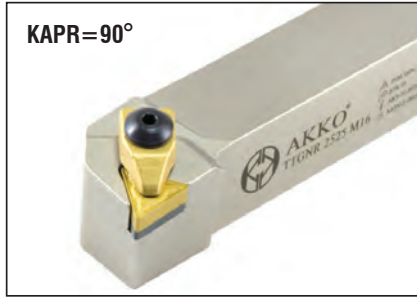

Takım Kodu Ordering Code Bestell-Bezeichnung	Stok Stock Lager		Takım Ölçüleri (mm) Dimension (mm) Abmessung (mm)				Kesici Uç Insert Wendeschneidplatte	Baskı Pabucu Wedge Clamp Spannpratze	Pabuç Vidası Clamp Screw Klemmschraube	Altlık Shim Unterlage	Altlık Vidası Shim Screw Schraube für Unterlage	Sekman Ring Feder	Pul Stamp Ring	Anahtar Allen Key Innerschlüssel
	R	L	HF=H	B	LF	WF								
<b>TTGNR/L 2020 K16</b>	●	●	20	20	125	25	<b>TNM. 1604..</b>	ATK-01	AKV-01-M5x22	AATN-2-0002	AAV-03-M5x12	-	ABPL-01	AAL-03-3
<b>2525 M16</b>	●	●	25	25	150	32								
<b>3232 P16</b>	●	●	32	32	170	40								
<b>2525 M22</b>	●	●	25	25	150	32	<b>TNM. 2204..</b>	ATK-02	AKV-30-M6x22	AATN-3-0015	AAV-02-M5x12	AS-01		
<b>3232 P22</b>	●	●	32	32	170	40								
<b>4040 S22</b>	○	○	40	40	250	50								

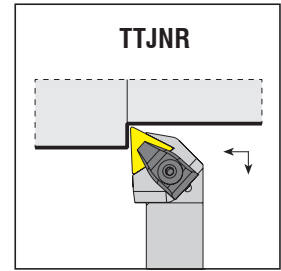
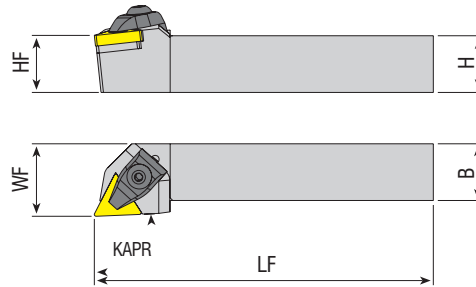
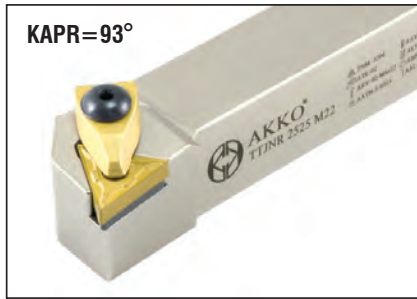

Takım Kodu Ordering Code Bestell-Bezeichnung	Stok Stock Lager		Takım Ölçüleri (mm) Dimension (mm) Abmessung (mm)				Kesici Uç Insert Wendeschneidplatte	Baskı Pabucu Wedge Clamp Spannpratze	Pabuç Vidası Clamp Screw Klemmschraube	Altlık Shim Unterlage	Altlık Vidası Shim Screw Schraube für Unterlage	Sekman Ring Feder	Pul Stamp Ring	Anahtar Allen Key Innerschlüssel
	R	L	HF=H	B	LF	WF								
<b>TTJNR/L 2020 K16</b>	●	●	20	20	125	25	<b>TNM. 1604..</b>	ATK-01	AKV-01-M5x22	AATN-2-0002	AAV-03-M5x12	-	ABPL-01	AAL-03-3
<b>2525 M16</b>	●	●	25	25	150	32								
<b>3232 P16</b>	●	●	32	32	170	40								
<b>2525 M22</b>	●	●	25	25	150	32	<b>TNM. 2204..</b>	ATK-02	AKV-30-M6x22	AATN-3-0015	AAV-02-M5x12	AS-01		
<b>3232 P22</b>	●	●	32	32	170	40								
<b>4040 S22</b>	○	○	40	40	250	50								

R: Sağ / Right / Rechts L: Sol/Left/Links

● Stokta / In Stock / Auf Lager ○ Stokta Yok / Non Stock Item / Kein Lagerartikel, Lieferzeit auf Anfrage

Sipariş Örneği/Ordering Example/Bestellbeispiel

1 ad./pcs./stück TTGNR 2020 K16

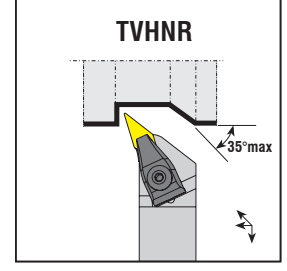
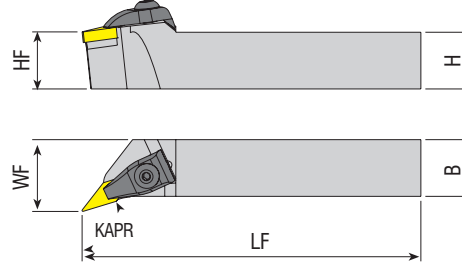

Takım Kodu Ordering Code Bestell-Bezeichnung	Stok Stock Lager		Takım Ölçüleri (mm) Dimension (mm) Abmessung (mm)				Kesici Uç Insert Wendeschneidplatte	Yedek Parçaları / Spare Parts / Ersatzteile						
	R	L	HF=H	B	LF	WF		Baskı Pabucu Wedge Clamp Spannpratze	Pabuç Vidası Clamp Screw Klemmschraube	Altlık Shim Unterlage	Altlık Vidası Shim Screw Schraube für Unterlage	Sekman Ring Feder	Pul Stamp Ring	Anahtar Allen Key Immereschlantschlüssel
TVHNR/L 2020 K16	●	●	20	20	125	25	VNM. 1604..	ATK-03	AKV-30-M6x22	AAVN-2-0002	AAV-04-M5x12	AS-01	ABPL-01	AAL-03-3
2525 M16	●	●	25	25	150	32								
3232 P16	●	●	32	32	170	40								

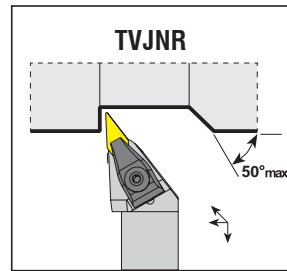
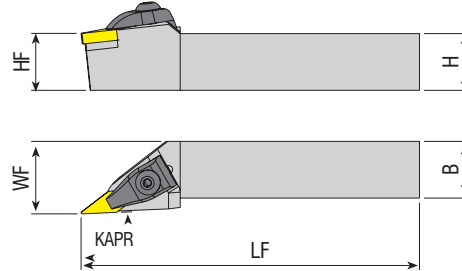

Takım Kodu Ordering Code Bestell-Bezeichnung	Stok Stock Lager		Takım Ölçüleri (mm) Dimension (mm) Abmessung (mm)				Kesici Uç Insert Wendeschneidplatte	Yedek Parçaları / Spare Parts / Ersatzteile						
	R	L	HF=H	B	LF	WF		Baskı Pabucu Wedge Clamp Spannpratze	Pabuç Vidası Clamp Screw Klemmschraube	Altlık Shim Unterlage	Altlık Vidası Shim Screw Schraube für Unterlage	Sekman Ring Feder	Pul Stamp Ring	Anahtar Allen Key Immereschlantschlüssel
TVJNR/L 2020 K16	●	●	20	20	125	25	VNM. 1604..	ATK-03	AKV-30-M6x22	AAVN-2-0002	AAV-04-M5x12	AS-01	ABPL-01	AAL-03-3
2525 M16	●	●	25	25	150	32								
3232 P16	●	●	32	32	170	40								

R: Sağ / Right / Rechts L: Sol/Left/Links

● Stokta / In Stock / Auf Lager ○ Stokta Yok / Non Stock Item / Kein Lagerartikel, Lieferzeit auf Anfrage

Sipariş Örneği/Ordering Example/Bestellbeispiel

1 ad./pcs./stück TVHNR 2020 K16



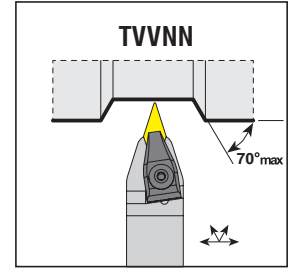
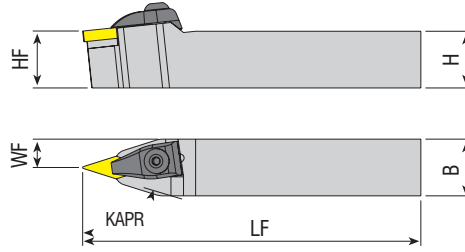

Takım Kodu Ordering Code Bestell-Bezeichnung	Stok Stock Lager		Takım Ölçüleri (mm) Dimension (mm) Abmessung (mm)				Kesici Uç Insert Wendeschneidplatte	Yedek Parçaları / Spare Parts / Ersatzteile						
	R	L	HF=H	B	LF	WF		Baskı Pabucu Wedge Clamp Spannpratze	Pabuç Vidası Clamp Screw Klemmschraube	Altılık Shim Unterlage	Altılık Vidası Shim Screw Schraube für Unterlage	Sekman Ring Feder	Pul Stamp Ring	Anahtar Allen Key Innensechskantschlüssel
TVVNN 2020 K16	●		20	20	125	10	VNM. 1604..	ATK-03	AKV-30-M6x22	AAVN-2-0002	AAV-04-M5x12	AS-01	ABPL-01	AAL-03-3
2525 M16	●		25	25	150	12.5								
3232 P16	●		32	32	170	16								

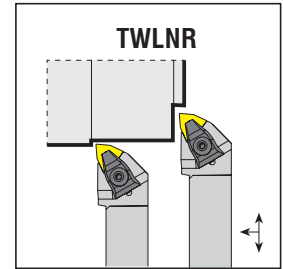
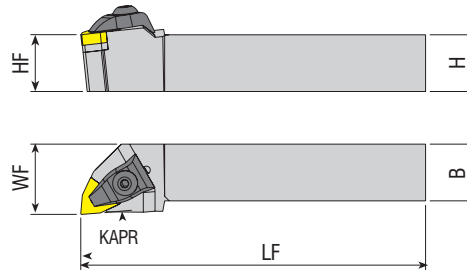

Takım Kodu Ordering Code Bestell-Bezeichnung	Stok Stock Lager		Takım Ölçüleri (mm) Dimension (mm) Abmessung (mm)				Kesici Uç Insert Wendeschneidplatte	Yedek Parçaları / Spare Parts / Ersatzteile						
	R	L	HF=H	B	LF	WF		Baskı Pabucu Wedge Clamp Spannpratze	Pabuç Vidası Clamp Screw Klemmschraube	Altılık Shim Unterlage	Altılık Vidası Shim Screw Schraube für Unterlage	Sekman Ring Feder	Pul Stamp Ring	Anahtar Allen Key Innensechskantschlüssel
TWLNR/L 1616 H06	●	●	16	16	100	20	WNM. 0604..	ATK-01	AKV-01-M5x22	AAWN-SW317	AAV-01-M3x10	-	ABPL-01	AAL-03-3
2020 K06	●	●	20	20	125	25								
2525 M06	●	●	25	25	150	32								
2020 K08	●	●	20	20	125	25	WNM. 0804..	ATK-02	AKV-30-M6x22	AAWN-3-0001	AAV-02-M5x12	AS-01	ABPL-01	AAL-03-3
2525 M08	●	●	25	25	150	32								
3232 P08	●	●	32	32	170	40								
4040 S08	●	●	40	40	250	50								
5050 S08	○	○	50	50	250	63								

R: Sağ / Right / Rechts L: Sol/Left/Links

● Stokta / In Stock / Auf Lager ○ Stokta Yok / Non Stock Item / Kein Lagerartikel, Lieferzeit auf Anfrage

Sipariş Örneği/Ordering Example/Bestellbeispiel

1 ad./pcs./stück TVVNN 2020 K16



*konusulan  
the spoken kalite...  
quality...*

# T-SİSTEM

**T-SİSTEM İÇTEN SOĞUTMA KANALLI DIŞ TORNA KATERLERİ**  
T-SYSTEM EXTERNAL TURNING TOOLHOLDERS WITH COOLANT TOOLS  
T-SYSTEM AUSSEN - DREHHALTER MIT INNENKÜHLUNG



**DETAYLI BİLGİ İÇİN BARKODU OKUTUNUZ**  
SCAN ME FOR MORE DETAILS  
SCANNEN SIE MICH NACH WEITEREN DETAILS



KAPR=95°

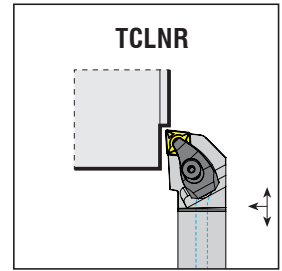
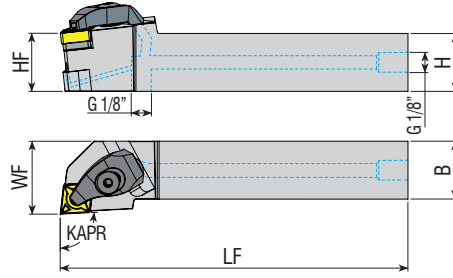
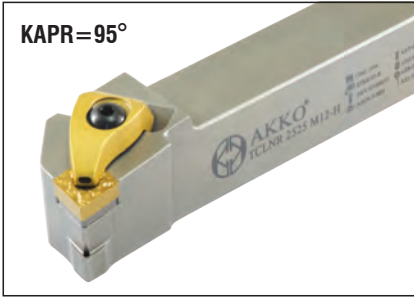

**Takım Kodu**  
**Ordering Code**  
**Bestell-Bezeichnung**

Stok Stock Lager		Takım Ölçüleri (mm) Dimension (mm) Abmessung (mm)			
R	L	HF=H	B	LF	WF

Kesici Uç  
Insert  
Wendeschneidplatte



Baskı Pabucu  
Wedge Clamp  
Spannpratze



Pabuç Vidası  
Clamp Screw  
Klemmschraube



Altlık  
Shim  
Unterlage



Altlık Vidası  
Shim Screw  
Schraube für Unterlage



Yay  
Spring  
Feder



Oring  
Ring  
Feder



Sızdırmaz Vida  
Threaded Pin  
Gewindestift



Anahtar  
Allen Key  
Innensechskantschlüssel



**TCLNR/L 2020 K12-H**  
**2525 M12-H**  
**3232 P12-H**

●	●	20	20	125	25
●	●	25	25	150	32
●	●	32	32	170	40

**CNM. 1204..**

ATKH-01-R  
ATKH-02-L

AKV-33-M6x22

AACN-3-0001

AAV-02-M5x12

AKY-01

AXR-01

2705-G1/8x5.5

AAL-03-3



KAPR=93°

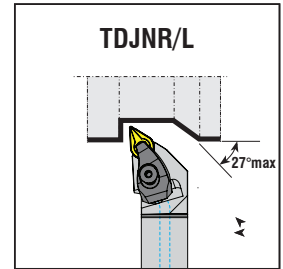
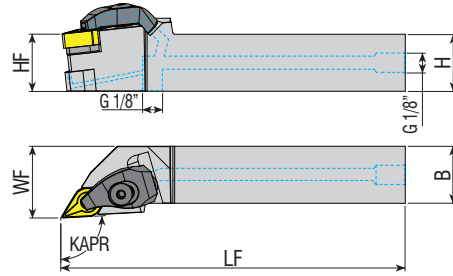

**Takım Kodu**  
**Ordering Code**  
**Bestell-Bezeichnung**

Stok Stock Lager		Takım Ölçüleri (mm) Dimension (mm) Abmessung (mm)			
R	L	HF=H	B	LF	WF

Kesici Uç  
Insert  
Wendeschneidplatte



Baskı Pabucu  
Wedge Clamp  
Spannpratze



Pabuç Vidası  
Clamp Screw  
Klemmschraube



Altlık  
Shim  
Unterlage



Altlık Vidası  
Shim Screw  
Schraube für Unterlage



Yay  
Spring  
Feder



Oring  
Ring  
Feder



Sızdırmaz Vida  
Threaded Pin  
Gewindestift



Anahtar  
Allen Key  
Innensechskantschlüssel



**TDJNR/L 2020 K15-H**  
**2525 M15-H**  
**3232 P15-H**

●	●	20	20	125	25
●	●	25	25	150	32
●	●	32	32	170	40

**DNM. 1506..**

ATKH-01-R  
ATKH-01-L

AKV-33-M6x22

AADN-3-0001

AAV-02-M5x12

AKY-01

AXR-01

2705-G1/8x5.5

AAL-03-3

R: Sağ / Right / Rechts L: Sol/Left/Links

● Stokta / In Stock / Auf Lager ○ Stokta Yok / Non Stock Item / Kein Lagerartikel, Lieferzeit auf Anfrage

Sipariş Örneği/Ordering Example/Bestellbeispiel

1 ad./pcs./stück TCLNR 2020 K12-H



T-SİSTEM İÇTEN SOĞUTMA KANALLI DIŞ TORNA KATERLERİ  
T-SYSTEM EXTERNAL TURNING TOOLHOLDERS WITH COOLANT TOOLS  
T-SYSTEM AUSSEN - DREHHALTER MIT INNENKÜHLUNG

new

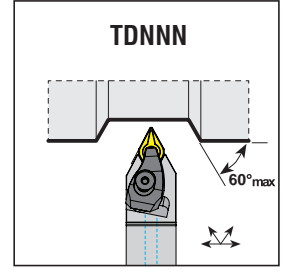
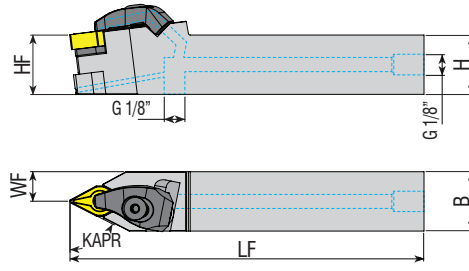

Takım Kodu Ordering Code Bestell-Bezeichnung	Stok Stock Lager		Takım Ölçüleri (mm) Dimension (mm) Abmessung (mm)				Kesici Uç Insert Wendeschneidplatte	Yedek Parçaları / Spare Parts / Ersatzteile								
	HF=H	B	LF	WF	Baskı Pabucu Wedge Clamp Spannpratze	Pabuç Vidası Clamp Screw Klemmschraube		Altlık Shim Unterlage	Altlık Vidası Shim Screw Schraube für Unterlage	Yay Spring Feder	Oring Ring Feder	Sızdırmaz Vidası Threaded Pin Gewindestift	Anahtar Allen Key Innerschraubenschlüssel			
<b>TDNNN 2525 M15-H</b>	●		25	25	150	32										

new

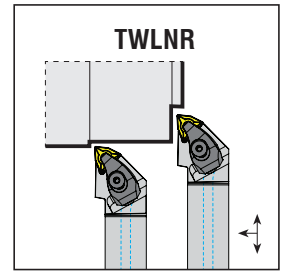
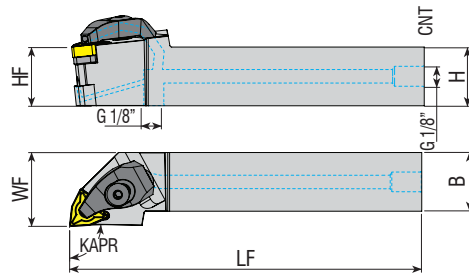

Takım Kodu Ordering Code Bestell-Bezeichnung	Stok Stock Lager		Takım Ölçüleri (mm) Dimension (mm) Abmessung (mm)				Kesici Uç Insert Wendeschneidplatte	Yedek Parçaları / Spare Parts / Ersatzteile								
	R	L	HF=H	B	LF	WF		Baskı Pabucu Wedge Clamp Spannpratze	Pabuç Vidası Clamp Screw Klemmschraube	Altlık Shim Unterlage	Altlık Vidası Shim Screw Schraube für Unterlage	Yay Spring Feder	Oring Ring Feder	Sızdırmaz Vidası Threaded Pin Gewindestift	Anahtar Allen Key Innerschraubenschlüssel	
<b>TWLNR/L 2020 K08-H</b>	●	●	20	20	125	25										
<b>2525 M08-H</b>	●	●	25	25	150	32										
<b>3232 P08-H</b>	●	●	32	32	170	40										

R: Sağ / Right / Rechts L: Sol/Left/Links

● Stokta / In Stock / Auf Lager ○ Stokta Yok / Non Stock Item / Kein Lagerartikel, Lieferzeit auf Anfrage

Sipariş Örneği/Ordering Example/Bestellbeispiel

1 ad./pcs./stück TDNNN 2525 M15-H

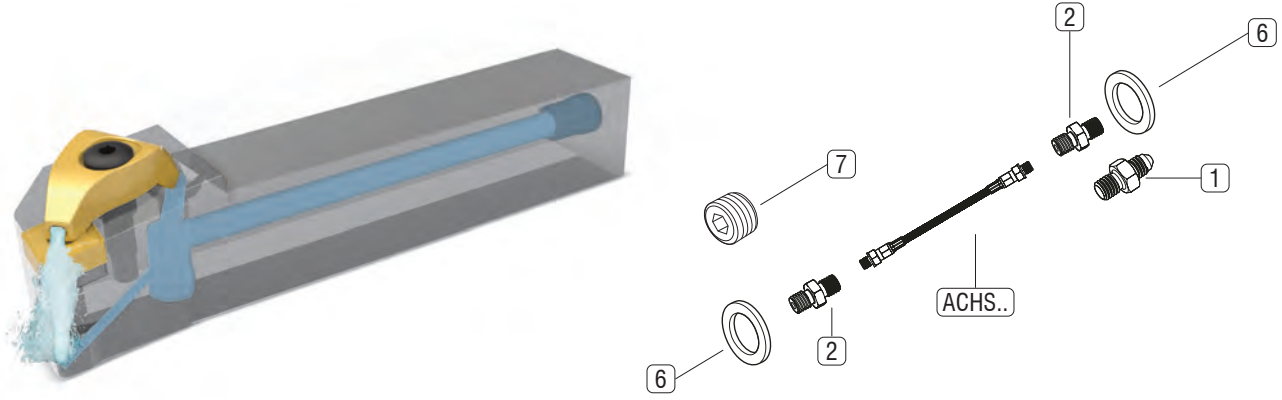

Not: İçten soğutmalı tüm torna katerlerinde kullanılacak 3 tip soğutma hortum setleri tasarlanmıştır. Takımların kullanılmasından önce, kullanılmayan bağlantıların set içindeki vida ile kapatılarak sızdırmazlığın sağlanmasına dikkat edilmelidir. Torna katerlerine yönelik soğutma hortum setleri, ACHS... 10 bar ile maksimum 275 bar basınç aralığında kullanılabilir.

Note: 3 types of cooling hose sets are designed that can be used in all internally cooled lathes. Before using the tools, care should be taken to ensure that the unused connections are closed with the screw in the set and that sealing is ensured. Cooling hose sets for lathe tools can be used in the pressure range of ACHS ... 10 bar to max 275 bar.

Notiz: Es wurden 3 Arten von Kühlschlauch-Sets entwickelt, die in allen intern gekühlten Drehmaschinen verwendet werden können. Vor der Verwendung der Werkzeuge sollte darauf geachtet werden, dass die nicht verwendeten Verbindungen mit der Schraube im Satz geschlossen werden und die Abdichtung gewährleistet ist. Kühlschlauchsätze für Drehmaschinen können im Druckbereich von ACHS ... 10 bar bis max. 275 bar eingesetzt werden.

Set içindeki Parçalar Parts In The Set Teile im Set				Uzunluk / Length Code / Länge		
Resim Picture Bild	Takım Kodu Set Code Code Einstellen	Ürün Açıklaması Product Description Artikelbeschreibung	Set Kodu: Set Code: Code Einstellen:	Set Kodu: Set Code: Code Einstellen:	Set Kodu: Set Code: Code Einstellen:	
			ACHS-1-250	ACHS-2-250	ACHS-3-250	
1	AMP-01	M10 Bağlantı Elemanı M10 Fastener M10 Verschluss	1x	-	-	
2	AMP-02	G 1/8" Çift Bağlantı Elemanı G 1/8" Double Fastener G 1/8" Doppelverschluss	2x	1x	-	
3	AMP-03	G 1/8" Açılı Bağlantısı G 1/8" Angle Connection G 1/8" Winkelverbindung	-	1x	2x	
4	AMP-04	M10" Açılı Bağlantısı M10" Angle Connection M10" Winkelverbindung	-	1x	1x	
5	AMP-05	G1/4"-G1/8" Kılcalma Parçası G1 / 4"-G1/8" Capillary Piece G1 / 4"-G1/8" Kapillarstück	-	1x	1x	
6	AG-01	Bakır Conta Copper Gasket Kupferdichtung	2x	3x	4x	
7	2705-G1/8-5.5	G1/8" Sızdırmaz Civata G1/8" Sealing Bolt G1/8" Dichtungsschraube	1x	1x	1x	
8	AH-1-250	Hortum Hose Schlauch	1x	-	-	
9	AH-2-250	Hortum Hose Schlauch	-	1x	-	
10	AH-3-250	Hortum Hose Schlauch	-	-	1x	



*konusulan  
the spoken kalite...  
quality...*

# M-SİSTEM

**M-SİSTEM DIŞ TORNA KATERLERİ**  
M-SYSTEM EXTERNAL TURNING TOOLHOLDERS  
M-SYSTEM AUSSEN - DREHHALTER





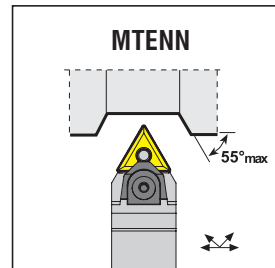
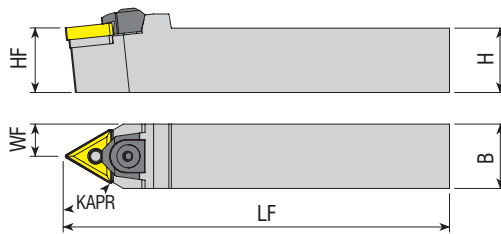

Takım Kodu Ordering Code Bestell-Bezeichnung	Stok Stock Lager	Takım Ölçüleri (mm) Dimension (mm) Abmessung (mm)				Kesici Uç Insert Wendeschneidplatte	Yedek Parçaları / Spare Parts / Ersatzteile						
		HF=H	B	LF	WF		Baskı Pabucu Wedge Clamp Spannpratze	Pabuç Vidası Clamp Screw Klemmschraube	Altlık Shim Unterlage	Pim Pin Stift	Sekman Ring Feder	Pul Stamp Ring	Anahtar Allen Key Innerschlüsselschlüssel
<b>MTENN 2020 K16</b>	●	20	20	125	10	TNM. 1604..	AMK-04	AKV-30-M6x22	AATN-2-0002	APM-01	AS-01	ABPL-01	AAL-03-3
<b>2525 M16</b>	●	25	25	150	12.5								
<b>3232 P16</b>	●	32	32	170	16								
<b>2525 M22</b>	●	25	25	150	12.5	TNM. 2204..	AMK-08	AKV-30-M6x22	AATN-3-0015	APM-02	AS-01	ABPL-01	AAL-03-3
<b>3232 P22</b>	●	32	32	170	16								
<b>4040 S22</b>	●	40	40	250	20								

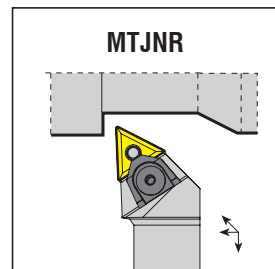
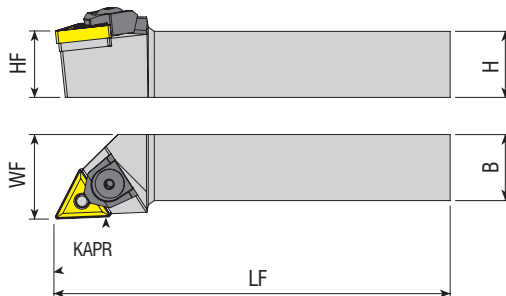
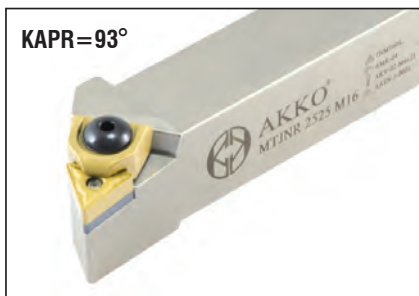

Takım Kodu Ordering Code Bestell-Bezeichnung	Stok Stock Lager		Takım Ölçüleri (mm) Dimension (mm) Abmessung (mm)				Kesici Uç Insert Wendeschneidplatte	Yedek Parçaları / Spare Parts / Ersatzteile						
	R	L	HF=H	B	LF	WF		Baskı Pabucu Wedge Clamp Spannpratze	Pabuç Vidası Clamp Screw Klemmschraube	Altlık Shim Unterlage	Pim Pin Stift	Sekman Ring Feder	Pul Stamp Ring	Anahtar Allen Key Innerschlüsselschlüssel
<b>MTJNR/L 2020 K16</b>	●	●	20	20	125	25	TNM. 1604..	AMK-04	AKV-30-M6x22	AATN-2-0002	APM-01	AS-01	ABPL-01	AAL-03-3
<b>2525 M16</b>	●	●	25	25	150	32								
<b>3232 P16</b>	●	●	32	32	170	40								
<b>2525 M22</b>	●	●	25	25	150	32	TNM. 2204..	AMK-08	AKV-30-M6x22	AATN-3-0015	APM-02	AS-01	ABPL-01	AAL-03-3
<b>3232 P22</b>	●	●	32	32	170	40								
<b>4040 S22</b>	●	●	40	40	250	50								

R: Sağ / Right / Rechts L: Sol/Left/Links

● Stokta / In Stock / Auf Lager ○ Stokta Yok / Non Stock Item / Kein Lagerartikel, Lieferzeit auf Anfrage

Sipariş Örneği/Ordering Example/Bestellbeispiel

1 ad./pcs./stück MTENN 2020 K16

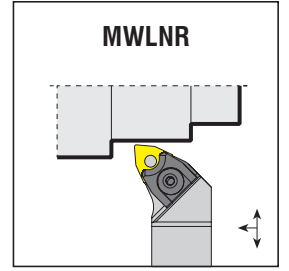
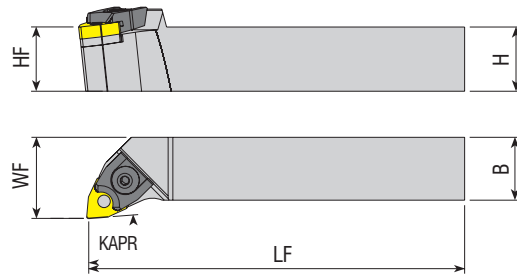

Takım Kodu Ordering Code Bestell-Bezeichnung	Stok Stock Lager		Takım Ölçüleri (mm) Dimension (mm) Abmessung (mm)				Kesici Uç Insert Wendeschneidplatte	Yedek Parçaları / Spare Parts / Ersatzteile							
	R	L	HF=H	B	LF	WF		Baskı Pabuçu Wedge Clamp Spannpratze	Pabuç Vidası Clamp Screw Klemmschraube	Altlık Shim Unterlage	Pim Pin Stift	Sekman Ring Feder	Pul Stamp Ring	Anahtar Allen Key Innensechskantschlüssel	
<b>MWLNR/L 1616 H06</b>	●	●	16	16	100	20	<b>WNM. 0604..</b>	AMK-01	AKV-04-M5x17	-	APM-08	-	-	AAL-03-3	
<b>2020 K06</b>	●	●	20	20	125	25									
<b>2525 M06</b>	●	●	25	25	150	32									
<b>2020 K08</b>	●	●	20	20	125	25	<b>WNM. 0804..</b>	AMK-05	AKV-03-M6x22	AAWN-3-0001	APM-02	AS-01	ABPL-01	AAL-03-3	
<b>2525 M08</b>	●	●	25	25	150	32									
<b>3232 P08</b>	●	●	32	32	170	40									

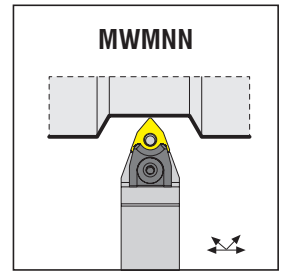
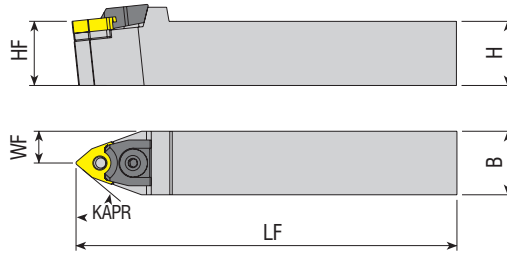

Takım Kodu Ordering Code Bestell-Bezeichnung	Stok Stock Lager		Takım Ölçüleri (mm) Dimension (mm) Abmessung (mm)				Kesici Uç Insert Wendeschneidplatte	Yedek Parçaları / Spare Parts / Ersatzteile							
	R	L	HF=H	B	LF	WF		Baskı Pabuçu Wedge Clamp Spannpratze	Pabuç Vidası Clamp Screw Klemmschraube	Altlık Shim Unterlage	Pim Pin Stift	Sekman Ring Feder	Pul Stamp Ring	Anahtar Allen Key Innensechskantschlüssel	
<b>MWMNN 1616 H06</b>	●	●	16	16	100	8	<b>WNM. 0604..</b>	AMK-01	AKV-04-M5x17	-	APM-08	-	-	AAL-03-3	
<b>2020 K06</b>	●	●	20	20	125	10									
<b>2525 M06</b>	●	●	25	25	150	12.5									
<b>2020 K08</b>	●	●	20	20	125	10	<b>WNM. 0804..</b>	AMK-05	AKV-03-M6x22	AAWN-3-0001	APM-02	AS-01	ABPL-01	AAL-03-3	
<b>2525 M08</b>	●	●	25	25	150	12.5									
<b>3232 P08</b>	●	●	32	32	170	16									

R: Sağ / Right / Rechts L: Sol/Left/Links

● Stokta / In Stock / Auf Lager ○ Stokta Yok / Non Stock Item / Kein Lagerartikel, Lieferzeit auf Anfrage

Sipariş Örneği/Ordering Example/Bestellbeispiel

1 ad./pcs./stück MWLNR 1616 H06

# P-SİSTEM

P-SİSTEM DIŞ TORNA KATERLERİ  
P-SYSTEM EXTERNAL TURNING TOOLHOLDERS  
P-SYSTEM AUSSEN - DREHHALTER

*konusulan  
the spoken kalite...  
quality...*



KAPR=75°

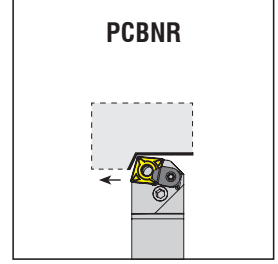
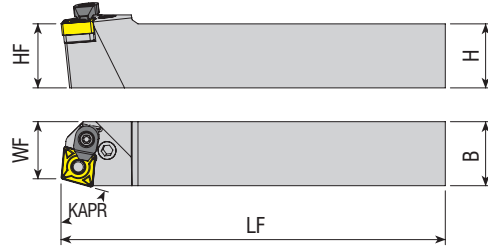
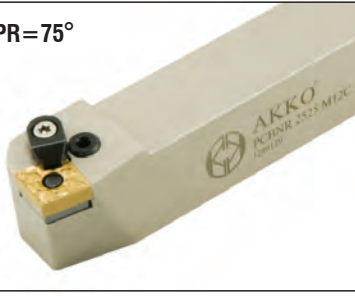

Takım Kodu  
Ordering Code  
Bestell-Bezeichnung

Stok Stock Lager	Takım Ölçüleri (mm) Dimension (mm) Abmessung (mm)						Kesici Uç Insert Wendeschneidplatte	Yedek Parçaları / Spare Parts / Ersatzteile							
	R	L	HF=H	B	LF	WF		Levyeye Lever Kniehebel	Levyeye Vidası Lever Screw Kniehebelschraube	Altılık Shim Unterlage	Altılık Yay Shim Spring Feder für Unterlage	Baskı Parçası Wedge Clamp Spannpratze	Baskı Vidası Clamp Screw Klemmschraube	Anahtar Allen Key Innerschraubenschlüssel	
PCBNR/L 2020 K12C	●	●	20	20	125	17.5	CNM. 1204..	APL-02	ALV-03-M8x19	AACN-3-0001	AAY-02	ACK-05	4015-M4x11	AAL-03-3	
2525 M12C	●	●	25	25	150	22.5									
3232 P12C	●	●	32	32	170	29.5									
2525 M16C	●	●	25	25	150	22	CNM. 1606..	APL-04	ALV-04-M8x22	AACN-3-0002	AAY-03	ACK-09	AAV-05-M6x15	AAL-05-4	
3232 P16C	●	●	32	32	170	27									
3232 P19C	●	●	32	32	170	27	CNM. 1906..	APL-05	ALV-05-M10x27	AACN-3-0003	AAY-04	ACK-09	AAV-05-M6x15	AAL-05-4	
4040 S19C	●	●	40	40	250	37									
4040 S25C	●	●	40	40	250	37	CNM. 2509..	APL-06	ALV-06-M12x36	AACN-3-0008	AAY-05	ACK-04	AKV-16-M6x16	AAL-07-5	
5050 S25C	○	○	50	50	250	47									

KAPR=95°

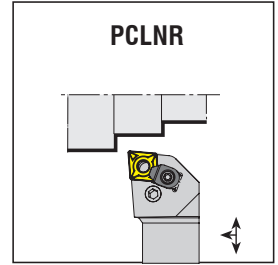
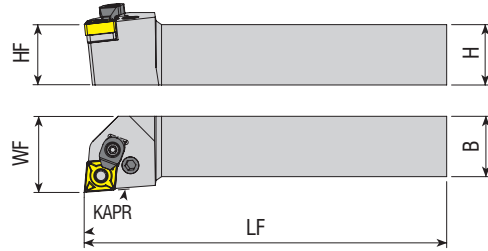
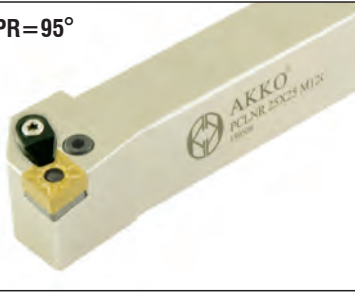

Takım Kodu  
Ordering Code  
Bestell-Bezeichnung

Stok Stock Lager	Takım Ölçüleri (mm) Dimension (mm) Abmessung (mm)						Kesici Uç Insert Wendeschneidplatte	Yedek Parçaları / Spare Parts / Ersatzteile							
	R	L	HF=H	B	LF	WF		Levyeye Lever Kniehebel	Levyeye Vidası Lever Screw Kniehebelschraube	Altılık Shim Unterlage	Altılık Yay Shim Spring Feder für Unterlage	Baskı Parçası Wedge Clamp Spannpratze	Baskı Vidası Clamp Screw Klemmschraube	Anahtar Allen Key Innerschraubenschlüssel	
PCLNR/L 1616 H09	●	●	16	16	100	20	CNM. 0903..	APL-01	ALV-02-M6x17	AACN-2-0002	AAY-01	-	-	AAL-02-2.5	
2020 K09	●	●	20	20	125	25									
2525 M09	●	●	25	25	150	32									
1616 H12	●	●	16	16	100	20	CNM. 1204..	APL-02	ALV-03-M8x19	AACN-3-0001	AAY-02	ACK-05	4015-M4x11	AAL-03-3	
2020 K12C	●	●	20	20	125	25									
2525 M12C	●	●	25	25	150	32									
3232 P12C	●	●	32	32	170	40	CNM. 1606..	APL-04	ALV-04-M8x22	AACN-3-0002	AAY-03	ACK-09	AAV-05-M6x15	AAL-05-4	
2525 M16C	●	●	25	25	150	32									
3232 P16C	●	●	32	32	170	40	CNM. 1906..	APL-05	ALV-05-M10x27	AACN-3-0003	AAY-04	ACK-09	AAV-05-M6x15	AAL-05-4	
2525 M19C	●	●	25	25	150	32									
3232 P19C	●	●	32	32	170	40	CNM. 2509..	APL-06	ALV-06-M12x36	AACN-3-0008	AAY-05	ACK-04	AKV-16-M6x16	AAL-07-5	
4040 S19C	●	●	40	40	250	50									
4040 S25C	●	●	40	40	250	50	CNM. 2509..	APL-06	ALV-06-M12x36	AACN-3-0008	AAY-05	ACK-04	AKV-16-M6x16	AAL-07-5	
5050 S25C	●	●	50	50	250	60									

R: Sağ / Right / Rechts L: Sol/Left/Links

● Stokta / In Stock / Auf Lager ○ Stokta Yok / Non Stock Item / Kein Lagerartikel, Lieferzeit auf Anfrage

Sipariş Örneği/Ordering Example/Bestellbeispiel

1 ad./pcs./stück PCBNR 2020 K12C



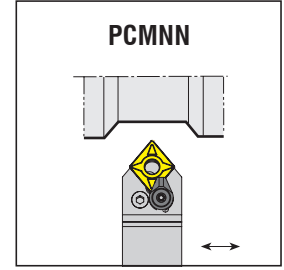
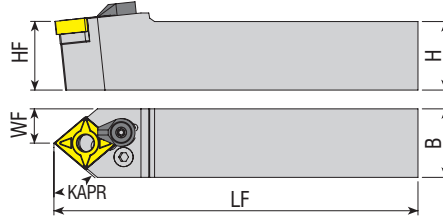

Takım Kodu Ordering Code Bestell-Bezeichnung	Stok Stock Lager	Takım Ölçüleri (mm) Dimension (mm) Abmessung (mm)				Kesici Uç Insert Wendeschneidplatte	Yedek Parçaları / Spare Parts / Ersatzteile						
		HF=H	B	LF	WF		Levyeye Lever Kniehebel	Levyeye Vidası Lever Screw Kniehebelschraube	Altılık Shim Unterlage	Altılık Yay Shim Spring Feder für Unterlage	Baskı Parçası Wedge Clamp Spannpratze	Baskı Vidası Clamp Screw Klemmschraube	Anahtar Allen Key Innerschraubenschlüssel
PCMNN 2020 K12C	●	20	20	125	10	CNM. 1204..	APL-02	ALV-03-M8x19	AACN-3-0001	AAY-02	ACK-05	4015-M4x11	AAL-03-3
2525 M12C	●	25	25	150	12.5								
3232 P12C	○	32	32	170	16	CNM. 1606..	APL-04	ALV-04-M8x22	AACN-3-0002	AAY-03	ACK-09	AAV-05-M6x15	AAL-05-4
2525 M16C	○	25	25	150	12.5								
3232 P16C	○	32	32	170	16	CNM. 1906..	APL-05	ALV-05-M10x27	AACN-3-0003	AAY-04	ACK-04	AKV-16-M6x16	AAL-07-5
3232 P19C	●	32	32	170	16								
4040 S19C	●	40	40	250	20	CNM. 2509..	APL-06	ALV-06-M12x36	AACN-3-0008	AAY-05	ACK-04	AKV-16-M6x16	AAL-07-5
5050 S19C	○	50	50	250	25								
4040 S25C	●	40	40	250	20								

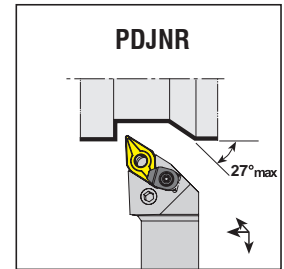
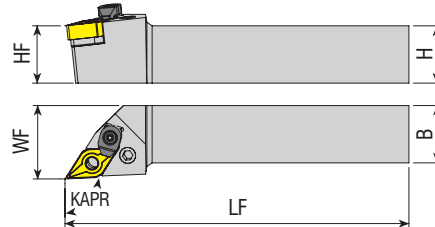

Takım Kodu Ordering Code Bestell-Bezeichnung	Stok Stock Lager		Takım Ölçüleri (mm) Dimension (mm) Abmessung (mm)				Kesici Uç Insert Wendeschneidplatte	Yedek Parçaları / Spare Parts / Ersatzteile						
	R	L	HF=H	B	LF	WF		Levyeye Lever Kniehebel	Levyeye Vidası Lever Screw Kniehebelschraube	Altılık Shim Unterlage	Altılık Yay Shim Spring Feder für Unterlage	Baskı Parçası Wedge Clamp Spannpratze	Baskı Vidası Clamp Screw Klemmschraube	Anahtar Allen Key Innerschraubenschlüssel
PDJNR/L 1616 H11	●	●	16	16	100	20	DNM. 1104..	APL-01	ALV-02-M6x17	AADN-SD317	AAY-01	-	-	AAL-02-2.5
2020 K11	●	●	20	20	125	25								
2525 M11	●	●	25	25	150	32	DNM. 1506..	APL-03	ALV-03-M8x19	AADN-3-0001	AAY-02	ACK-05	4015-M4x11	AAL-03-3
2020 K15C	●	●	20	20	125	25								
2525 M15C	●	●	25	25	150	32								
3232 P15C	●	●	32	32	170	40								
4040 S15C	●	●	40	40	250	50								

R: Sağ / Right / Rechts L: Sol/Left/Links

● Stokta / In Stock / Auf Lager ○ Stokta Yok / Non Stock Item / Kein Lagerartikel, Lieferzeit auf Anfrage

Sipariş Örneği/Ordering Example/Bestellbeispiel

1 ad./pcs./stück PCMN 2020 K12C

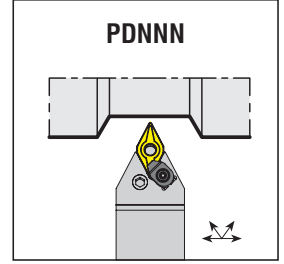
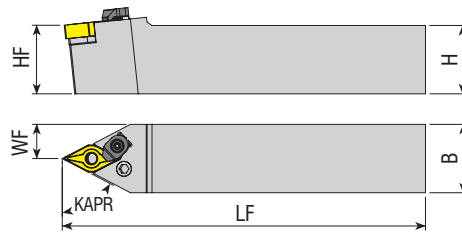

Takım Kodu Ordering Code Bestell-Bezeichnung	Stok Stock Lager		Takım Ölçüleri (mm) Dimension (mm) Abmessung (mm)				Kesici Uç Insert Wendeschneidplatte	Yedek Parçaları / Spare Parts / Ersatzteile						
	R	L	HF=H	B	LF	WF		Levyeye Lever Kniehebel	Levyeye Vidası Lever Screw Kniehebelschraube	Altılık Shim Unterlage	Altılık Yay Shim Spring Feder für Unterlage	Baskı Parçası Wedge Clamp Spannpratze	Baskı Vidası Clamp Screw Klemmschraube	Anahtar Allen Key Innerschlüsselschlüssel
<b>PDNNN 1616 H11</b>	●		16	16	100	8								
<b>2020 K11</b>	●		20	20	125	10	<b>DNM. 1104..</b>	APL-01	ALV-02-M6x17	AADN-SD317	AAY-01	-	-	AAL-02-2.5
<b>2525 M11</b>	●		25	25	150	12.5								
<b>2020 K15C</b>	●		20	20	125	10								
<b>2525 M15C</b>	●		25	25	150	12.5	<b>DNM. 1506..</b>	APL-03	ALV-03-M8x19	AADN-3-0001	AAY-02	ACK-05	4015-M4x11	AAL-03-3
<b>3232 P15C</b>	●		32	32	170	16								

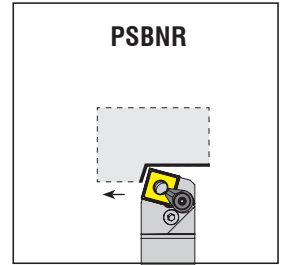
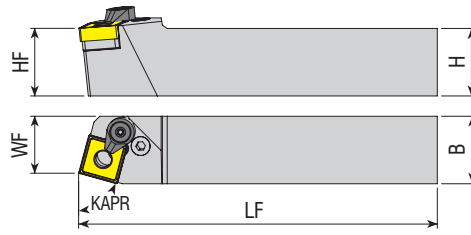
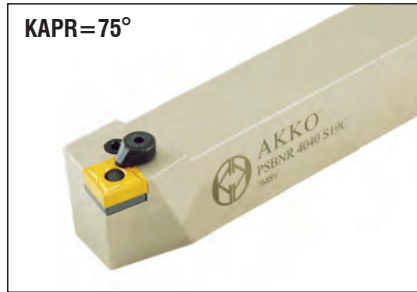

Takım Kodu Ordering Code Bestell-Bezeichnung	Stok Stock Lager		Takım Ölçüleri (mm) Dimension (mm) Abmessung (mm)				Kesici Uç Insert Wendeschneidplatte	Yedek Parçaları / Spare Parts / Ersatzteile						
	R	L	HF=H	B	LF	WF		Levyeye Lever Kniehebel	Levyeye Vidası Lever Screw Kniehebelschraube	Altılık Shim Unterlage	Altılık Yay Shim Spring Feder für Unterlage	Baskı Parçası Wedge Clamp Spannpratze	Baskı Vidası Clamp Screw Klemmschraube	Anahtar Allen Key Innerschlüsselschlüssel
<b>PSBNR/L 1616 H09</b>	●	●	16	16	100	13								
<b>2020 K09</b>	○	○	20	20	125	17	<b>SNM. 0903..</b>	APL-01	ALV-02-M6x17	AASN-2-0002	AAY-01	-	-	AAL-02-2.5
<b>2020 K12</b>	●	●	20	20	125	17								
<b>2525 M12C</b>	●	●	25	25	150	22	<b>SNM. 1204..</b>	APL-02	ALV-03-M8x19	AASN-3-0004	AAY-02	ACK-05	4015-M4x11	AAL-03-3
<b>3232 P12C</b>	●	●	32	32	170	27								
<b>2525 M15</b>	●	●	25	25	150	22	<b>SNM. 1506..</b>	APL-04	ALV-04-M8x22	AASN-3-0023	AAY-03	-	-	
<b>3232 P15C</b>	●	●	32	32	170	27								
<b>3232 P19C</b>	●	●	32	32	170	27	<b>SNM. 1906..</b>	APL-05	ALV-05-M10x27	AASN-3-0005	AAY-04	ACK-09	AAV-05-M6x15	AAL-05-4
<b>4040 S19C</b>	●	●	40	40	250	35								
<b>4040 S25C</b>	●	●	40	40	250	35	<b>SNM. 2509..</b>	APL-06	ALV-06-M12x36	AASN-3-0020	AAY-05	ACK-04	AKV-16-M6x16	AAL-07-5
<b>5050 S25C</b>	●	○	50	50	250	43								

R: Sağ / Right / Rechts L: Sol/Left/Links

● Stokta / In Stock / Auf Lager ○ Stokta Yok / Non Stock Item / Kein Lagerartikel, Lieferzeit auf Anfrage

Sipariş Örneği/Ordering Example/Bestellbeispiel

1 ad./pcs./stück PDNNN 1616 H11

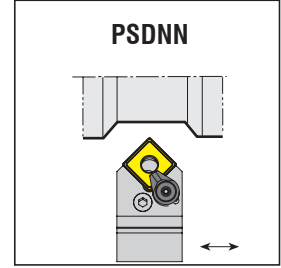
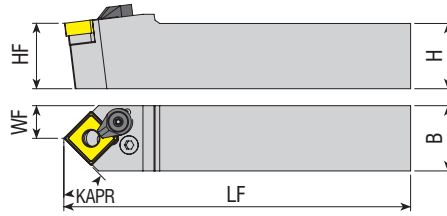

Takım Kodu Ordering Code Bestell-Bezeichnung	Stok Stock Lager	Takım Ölçüleri (mm) Dimension (mm) Abmessung (mm)				Kesici Uç Insert Wendeschneidplatte	Yedek Parçaları / Spare Parts / Ersatzteile						
		HF=H	B	LF	WF		Levye Lever Kniehebel	Levye Vidası Lever Screw Kniehebelschraube	Altlık Shim Unterlage	Altlık Yay Shim Spring Feder für Unterlage	Baskı Parçası Wedge Clamp Spannpratze	Baskı Vidası Clamp Screw Klemmschraube	Anahtar Allen Key Innensechskantschlüssel
PSDNN 1616 H09	●	16	16	100	8	SNM. 0903..	APL-01	ALV-02-M6x17	AASN-2-0002	AAAY-01	-	-	AAL-02-2.5
2020 K12C	●	20	20	125	10	SNM. 1204..	APL-02	ALV-03-M8x19	AASN-3-0004	AAAY-02	ACK-05	4015-M4x11	AAL-03-3
2525 M12C	●	25	25	150	12.5								
3232 P12C	●	32	32	170	16								
2020 K15	○	20	20	125	10	SNM. 1506..	APL-04	ALV-04-M8x22	AASN-3-0023	AAAY-03	-	-	AAL-05-4
2525 M15C	●	25	25	150	12.5								
3232 P19C	●	32	32	170	16								
4040 S19C	○	40	40	250	20	SNM. 1906..	APL-05	ALV-05-M10x27	AASN-3-0005	AAAY-04	ACK-09	AAV-05-M6x15	AAL-05-4
5050 S19C	○	50	50	250	25								
4040 S25C	●	40	40	250	20	SNM. 2509..	APL-06	ALV-06-M12x36	AASN-3-0020	AAAY-05	ACK-04	AKV-16-M6x16	AAL-07-5
5050 S25C	○	50	50	250	25								

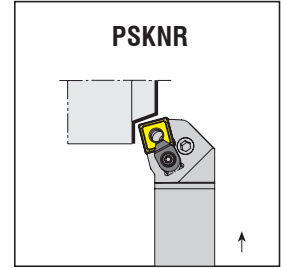
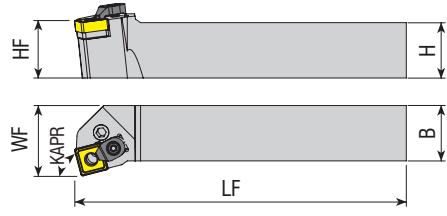

Takım Kodu Ordering Code Bestell-Bezeichnung	Stok Stock Lager		Takım Ölçüleri (mm) Dimension (mm) Abmessung (mm)				Kesici Uç Insert Wendeschneidplatte	Yedek Parçaları / Spare Parts / Ersatzteile						
	R	L	HF=H	B	LF	WF		Levye Lever Kniehebel	Levye Vidası Lever Screw Kniehebelschraube	Altlık Shim Unterlage	Altlık Yay Shim Spring Feder für Unterlage	Baskı Parçası Wedge Clamp Spannpratze	Baskı Vidası Clamp Screw Klemmschraube	Anahtar Allen Key Innensechskantschlüssel
PSKNR/L 2020 K09	●	○	20	20	125	25	SNM. 0903..	APL-01	ALV-02-M6x17	AASN-2-0002	AAAY-01	-	-	AAL-02-2.5
2020 K12C	●	●	20	20	125	25	SNM. 1204..	APL-02	ALV-03-M8x19	AASN-3-0004	AAAY-02	ACK-05	4015-M4x11	AAL-03-3
2525 M12C	●	●	25	25	150	32								
3232 P12C	●	●	32	32	170	40								
2525 M15C	●	●	25	25	150	32	SNM. 1506..	APL-04	ALV-04-M8x22	AASN-3-0023	AAAY-03	-	-	AAL-05-4
3232 P15C	●	●	32	32	170	40								
3232 P19C	●	●	32	32	170	40								
4040 S19C	●	●	40	40	250	50	SNM. 1906..	APL-05	ALV-05-M10x27	AASN-3-0005	AAAY-04	ACK-09	AAV-05-M6x15	AAL-05-4
4040 S25C	●	●	40	40	250	50								
5050 S25C	●	○	50	50	250	60	SNM. 2509..	APL-06	ALV-06-M12x36	AASN-3-0020	AAAY-05	ACK-04	AKV-16-M6x16	AAL-07-5

R: Sağ / Right / Rechts L: Sol/Left/Links

● Stokta / In Stock / Auf Lager ○ Stokta Yok / Non Stock Item / Kein Lagerartikel, Lieferzeit auf Anfrage

Sipariş Örneği/Ordering Example/Bestellbeispiel

1 ad./pcs./stück PSDNN 1616 H09

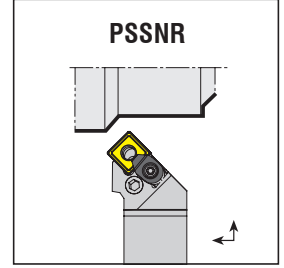
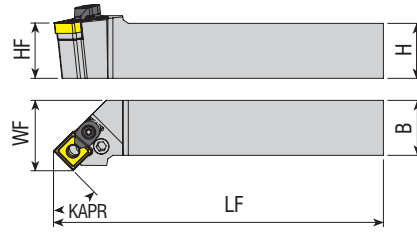

Takım Kodu Ordering Code Bestell-Bezeichnung	Stok Stock Lager		Takım Ölçüleri (mm) Dimension (mm) Abmessung (mm)				Kesici Uç Insert Wendeschneidplatte	Levyeye Lever Kniehebel	Levyeye Vidası Lever Screw Kniehebelschraube	Altılık Shim Unterlage	Altılık Yay Shim Spring Feder für Unterlage	Baskı Parçası Wedge Clamp Spannpratze	Baskı Vidası Clamp Screw Klemmschraube	Anahtar Allen Key Immerchtschlüssel
	R	L	HF=H	B	LF	WF								
<b>PSSNR/L 1616 H09</b>	●	●	16	16	100	20	<b>SNM. 0903..</b>	APL-01	ALV-02-M6x17	AASN-2-0002	AAY-01	-	-	AAL-02-2.5
<b>2020 K09</b>	●	○	20	20	125	25								
<b>2020 K12C</b>	●	●	20	20	125	25	<b>SNM. 1204..</b>	APL-02	ALV-03-M8x19	AASN-3-0004	AAY-02	ACK-05	4015-M4x11	AAL-03-3
<b>2525 M12C</b>	●	●	25	25	150	32								
<b>3232 P12C</b>	●	●	32	32	170	40	<b>SNM. 1506..</b>	APL-04	ALV-04-M8x22	AASN-3-0023	AAY-03			
<b>3232 P15C</b>	●	○	32	32	170	40								
<b>3232 P19C</b>	●	●	32	32	170	40	<b>SNM. 1906..</b>	APL-05	ALV-05-M10x27	AASN-3-0005	AAY-04	ACK-09	AAV-05-M6x15	AAL-05-4
<b>4040 S19C</b>	●	●	40	40	250	50								
<b>4040 S25C</b>	●	●	40	40	250	50	<b>SNM. 2509..</b>	APL-06	ALV-06-M12x36	AASN-3-0020	AAY-05	ACK-04	AKV-16-M6x16	AAL-07-5

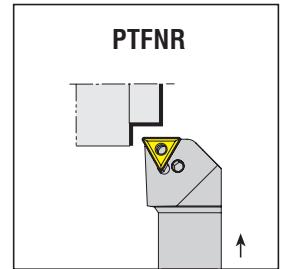
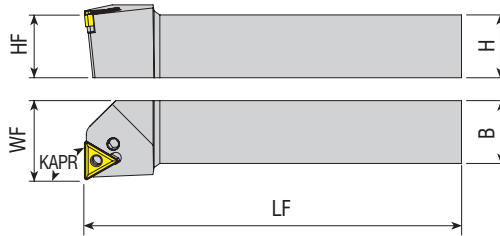

Takım Kodu Ordering Code Bestell-Bezeichnung	Stok Stock Lager		Takım Ölçüleri (mm) Dimension (mm) Abmessung (mm)				Kesici Uç Insert Wendeschneidplatte	Levyeye Lever Kniehebel	Levyeye Vidası Lever Screw Kniehebelschraube	Altılık Shim Unterlage	Altılık Yay Shim Spring Feder für Unterlage	Baskı Parçası Wedge Clamp Spannpratze	Baskı Vidası Clamp Screw Klemmschraube	Anahtar Allen Key Immerchtschlüssel
	R	L	HF=H	B	LF	WF								
<b>PTFNR/L 1616 H16</b>	●	●	16	16	100	20	<b>TNM. 1604..</b>	APL-01	ALV-02-M6x17	AATN-3-0025	AAY-01	-	-	AAL-02-2.5
<b>2020 K16</b>	●	●	20	20	125	25								
<b>2525 M16</b>	●	●	25	25	150	32								
<b>3232 P16</b>	●	●	32	32	170	40	<b>TNM. 2204..</b>	APL-02	ALV-03-M8x19	AATN-3-0015	AAY-02	ACK-05	4015-M4x11	AAL-03-3
<b>2525 M22C</b>	●	●	25	25	150	32								
<b>3232 P22C</b>	●	●	32	32	170	40	<b>TNM. 2706.</b>	APL-05	ALV-05-M10x27	07042701	AAY-04	ACK-09	AAV-05-M6x15	AAL-05-4
<b>4040 S27C</b>	○	○	40	40	250	50								

R: Sağ / Right / Rechts L: Sol/Left/Links

● Stokta / In Stock / Auf Lager ○ Stokta Yok / Non Stock Item / Kein Lagerartikel, Lieferzeit auf Anfrage

Sipariş Örneği/Ordering Example/Bestellbeispiel

1 ad./pcs./stück PSSNR 1616 H09



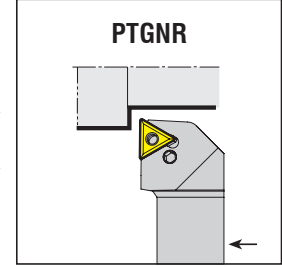
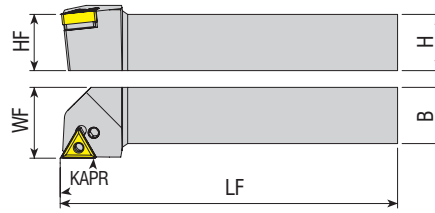

Takım Kodu Ordering Code Bestell-Bezeichnung	Stok Stock Lager		Takım Ölçüleri (mm) Dimension (mm) Abmessung (mm)				Kesici Uç Insert Wendeschneidplatte	Yedek Parçaları / Spare Parts / Ersatzteile						
	R	L	HF=H	B	LF	WF		Levye Lever Kniehebel	Levye Vidası Lever Screw Kniehebelschraube	Altlık Shim Unterlage	Altlık Yayı Shim Spring Feder für Unterlage	Baskı Parçası Wedge Clamp Spannpratze	Baskı Vidası Clamp Screw Klemmschraube	Anahtar Allen Key Innensechskantschlüssel
PTGNR/L 1010 E11	○	○	10	10	70	12	TNM. 1103..	APL-11	ALV-10-M5X10	-	-	-	-	AAL-13-2.5
1212 F11	○	○	12	12	80	16								
1616 H11	○	○	16	16	100	20								
1616 H16	●	●	16	16	100	20	TNM. 1604..	APL-01	ALV-02-M6x17	AATN-3-0025	AAY-01	-	-	AAL-02-2.5
2020 K16	●	●	20	20	125	25								
2525 M16	●	●	25	25	150	32								
3232 P16	○	○	32	32	170	40	TNM. 2204..	APL-02	ALV-03-M8x19	AATN-3-0015	AAY-02	ACK-05	4015-M4x11	AAL-03-3
2525 M22C	●	●	25	25	150	32								
3232 P22C	●	●	32	32	170	40								
4040 S27C	○	○	40	40	250	50	TNM. 2706..	APL-05	ALV-05-M10x27	07042701	AAY-04	ACK-09	AAV-05-M6x15	AAL-05-4

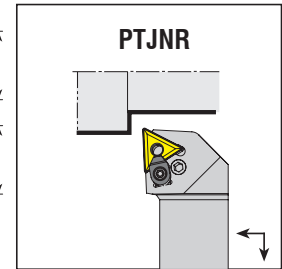
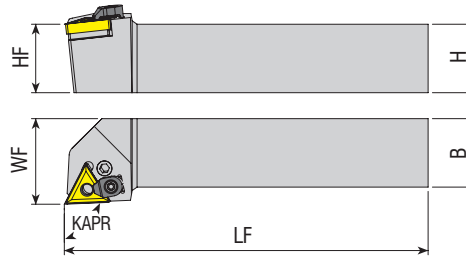

Takım Kodu Ordering Code Bestell-Bezeichnung	Stok Stock Lager		Takım Ölçüleri (mm) Dimension (mm) Abmessung (mm)				Kesici Uç Insert Wendeschneidplatte	Yedek Parçaları / Spare Parts / Ersatzteile						
	R	L	HF=H	B	LF	WF		Levye Lever Kniehebel	Levye Vidası Lever Screw Kniehebelschraube	Altlık Shim Unterlage	Altlık Yayı Shim Spring Feder für Unterlage	Baskı Parçası Wedge Clamp Spannpratze	Baskı Vidası Clamp Screw Klemmschraube	Anahtar Allen Key Innensechskantschlüssel
PTJNR/L 1010 E11	○	○	10	10	70	12	TNM. 1103..	APL-11	ALV-10-M5X10	-	-	-	-	AAL-13-2.5
1212 F11	○	○	12	12	80	16								
1616 H11	○	○	16	16	100	20								
1616 H16	●	●	16	16	100	20	TNM. 1604..	APL-01	ALV-02-M6x17	AATN-3-0025	AAY-01	-	-	AAL-02-2.5
2020 K16	●	●	20	20	125	25								
2525 M16	●	●	25	25	150	32								
3232 P16	●	●	32	32	170	40	TNM. 2204..	APL-02	ALV-03-M8x19	AATN-3-0015	AAY-02	ACK-05	4015-M4x11	AAL-03-3
2525 M22C	●	●	25	25	150	32								
3232 P22C	●	●	32	32	170	40								
4040 S27C	○	○	40	40	250	50	TNM. 2706..	APL-05	ALV-05-M10x27	07042701	AAY-04	ACK-09	AAV-05-M6x15	AAL-05-4

R: Sağ / Right / Rechts L: Sol/Left/Links

● Stokta / In Stock / Auf Lager ○ Stokta Yok / Non Stock Item / Kein Lagerartikel, Lieferzeit auf Anfrage

Sipariş Örneği/Ordering Example/Bestellbeispiel

1 ad./pcs./stück PTGNR 1010 E11

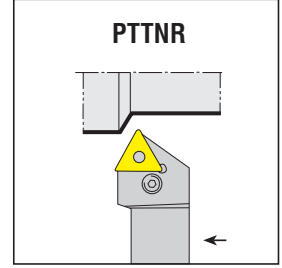
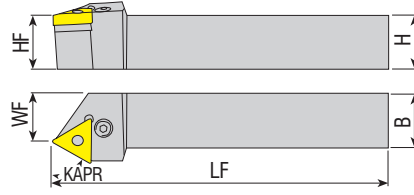
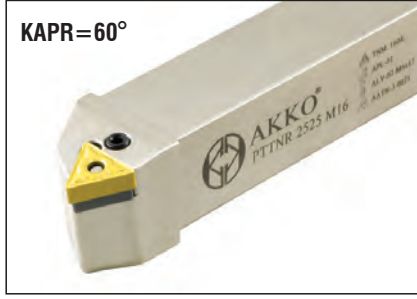

Takım Kodu Ordering Code Bestell-Bezeichnung	Stok Stock Lager		Takım Ölçüleri (mm) Dimension (mm) Abmessung (mm)				Kesici Uç Insert Wendescheidplatte	Levyeye Lever Kniehebel	Levyeye Vidası Lever Screw Kniehebelschraube	Altılık Shim Unterlage	Altılık Yayı Shim Spring Feder für Unterlage	Baskı Parçası Wedge Clamp Spannpratze	Baskı Vidası Clamp Screw Klemmschraube	Anahtar Allen Key Innerschlüssel
	R	L	HF=H	B	LF	WF								
<b>PTTNR/L 1616 H16</b>	●	●	16	16	100	13	<b>TNM. 1604..</b>	APL-01	ALV-02-M6x17	AATN-3-0025	AAAY-01	-	-	AAL-02-2.5
<b>2020 K16</b>	●	●	20	20	125	17								
<b>2525 M16</b>	●	●	25	25	150	21.5								
<b>3232 P16</b>	●	●	32	32	170	31								
<b>2525 M22C</b>	●	●	25	25	150	20.5	<b>TNM. 2204..</b>	APL-02	ALV-03-M8x19	AATN-3-0015	AAAY-02	ACK-05	4015-M4x11	AAL-03-3
<b>3232 P22C</b>	●	●	32	32	170	29								

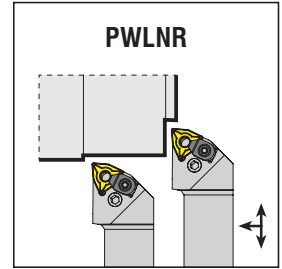
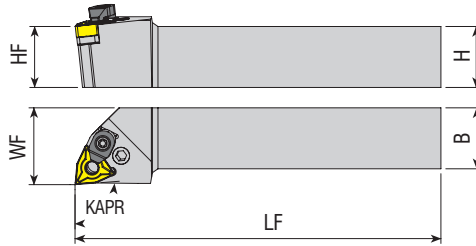

Takım Kodu Ordering Code Bestell-Bezeichnung	Stok Stock Lager		Takım Ölçüleri (mm) Dimension (mm) Abmessung (mm)				Kesici Uç Insert Wendescheidplatte	Levyeye Lever Kniehebel	Levyeye Vidası Lever Screw Kniehebelschraube	Altılık Shim Unterlage	Altılık Yayı Shim Spring Feder für Unterlage	Baskı Parçası Wedge Clamp Spannpratze	Baskı Vidası Clamp Screw Klemmschraube	Anahtar Allen Key Innerschlüssel
	R	L	HF=H	B	LF	WF								
<b>PWLNR/L 1616 H06</b>	●	●	16	16	100	20	<b>WNM. 0604..</b>	APL-01	ALV-02-M6x17	AAWN-SW317	AAAY-01	-	-	AAL-02-2.5
<b>2020 K06</b>	●	●	20	20	125	25								
<b>2525 M06</b>	●	●	25	25	150	32								
<b>3232 P06</b>	○	○	32	32	170	40								
<b>1616 H08</b>	●	●	16	16	100	20	<b>WNM. 0804..</b>	APL-02	ALV-03-M8x19	AAWN-3-0001	AAAY-02	ACK-05	4015-M4x11	AAL-03-3
<b>2020 K08C</b>	●	●	20	20	125	25								
<b>2525 M08C</b>	●	●	25	25	150	32								
<b>3232 P08C</b>	●	●	32	32	170	40								

R: Sağ / Right / Rechts L: Sol/Left/Links

● Stokta / In Stock / Auf Lager ○ Stokta Yok / Non Stock Item / Kein Lagerartikel, Lieferzeit auf Anfrage

Sipariş Örneği/Ordering Example/Bestellbeispiel

1 ad./pcs./stück PTTNR 1616 H16

# P-SİSTEM

**P-SİSTEM İÇTEN SOĞUTMA KANALLI DIŞ TORNA KATERLERİ**  
P-SYSTEM EXTERNAL TURNING TOOLHOLDERS WITH COOLANT TOOLS  
P-SYSTEM AUSSEN - DREHHALTER MIT INNENKÜHLUNG

**konusulan**  
**the spoken kalite...**  
**quality...**



**DETAYLI BİLGİ İÇİN BARKODU OKUTUNUZ**

SCAN ME FOR MORE DETAILS

SCANNEN SIE MICH NACH WEITEREN DETAILS

new

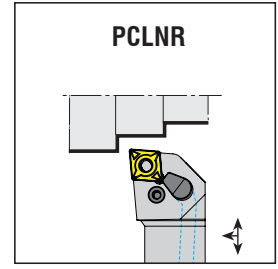
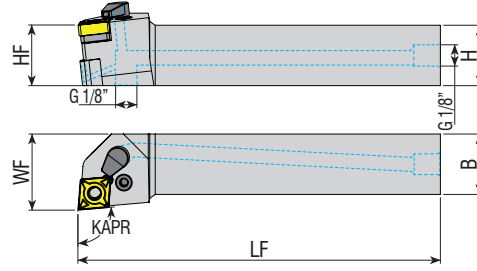

Takım Kodu  
Ordering Code  
Bestell-Bezeichnung

Stok Stock Lager	Takım Ölçüleri (mm) Dimension (mm) Abmessung (mm)						Kesici Uç Insert Wendeschneidplatte	Levyeye Lever Kniehebel	Levyeye Vidası Lever Screw Kniehebelschraube	Altılık Shim Unterlage	Altılık Yayı Shim Spring Feder für Unterlage	Oring Ring Feder	Sızdırmaz Vida Threaded Pin Gewindestift	Nozzle Nozzle	Anahtar Allen Key Innerschlüsselsattel
	R	L	HF=H	B	LF	WF									
PCLNR/L 2020 K12-H	●	●	20	20	125	25	CNM. 1204..	APL-02	ALV-03-M8x19	AACN-3-0001	AAV-02	AXR-01 AOR-01	2705-G1/8x5.5	AN-01	AAL-03-3
2525 M12-H	●	●	25	25	150	32									
3232 P12-H	●	○	32	32	170	40									

new

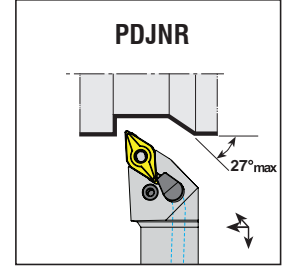
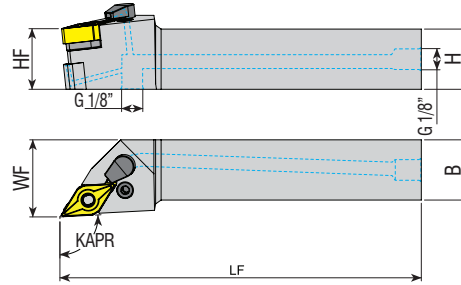

Takım Kodu  
Ordering Code  
Bestell-Bezeichnung

Stok Stock Lager	Takım Ölçüleri (mm) Dimension (mm) Abmessung (mm)						Kesici Uç Insert Wendeschneidplatte	Levyeye Lever Kniehebel	Levyeye Vidası Lever Screw Kniehebelschraube	Altılık Shim Unterlage	Altılık Yayı Shim Spring Feder für Unterlage	Oring Ring Feder	Sızdırmaz Vida Threaded Pin Gewindestift	Nozzle Nozzle	Anahtar Allen Key Innerschlüsselsattel
	R	L	HF=H	B	LF	WF									
PDJNR/L 2020 K15-H	●	●	20	20	125	25	DNM. 1506..	APL-03	ALV-03-M8x19	AADN-3-0001	AAV-02	AXR-01 AOR-01	2705-G1/8x5.5	AN-01	AAL-03-3
2525 M15-H	●	●	25	25	150	32									
3232 P15-H	●	○	32	32	170	40									

R: Sağ / Right / Rechts L: Sol/Left/Links

● Stokta / In Stock / Auf Lager ○ Stokta Yok / Non Stock Item / Kein Lagerartikel, Lieferzeit auf Anfrage

Sipariş Örneği/Ordering Example/Bestellbeispiel

1 ad./pcs./stück PCLNR 2020 K12-H

AKKO®

www.akko.com.tr



new

KAPR=62.5°

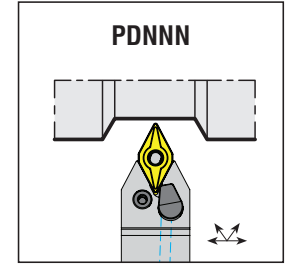
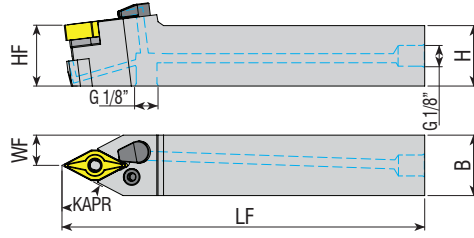

Takım Kodu  
Ordering Code  
Bestell-Bezeichnung

Stok Stock Lager	Takım Ölçüleri (mm) Dimension (mm) Abmessung (mm)					Kesici Uç Insert Wendeschneidplatte	Yedek Parçaları / Spare Parts / Ersatzteile									
	HF=H	B	LF	WF	Levyeye Lever Kniehebel		Levyeye Vidası Lever Screw Kniehehelschraube	Altılık Shim Unterlage	Altılık Yayını Shim Spring Feder für Unterlage	Oring Ring Feder	Sızdırmaz Vida Threaded Pin Gewindestift	Nozzle Nozzle Nozzle	Anahtar Allen Key Innerschlüssel			
●	25	25	150	32		DNM. 1506..	APL-03	ALV-03-M8x19	AADN-3-0001	AAAY-02	AXR-01 AOR-01	2705-G1/8x5.5	AN-01	AAL-03-3		

new

KAPR=95°

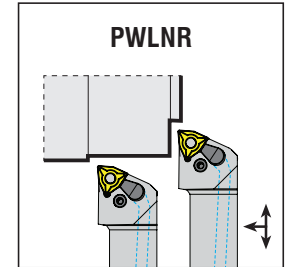
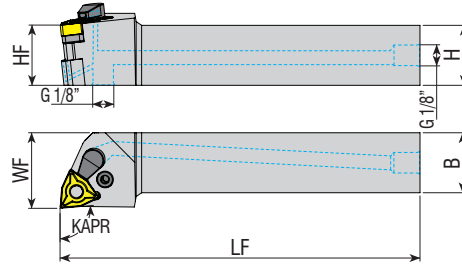

Takım Kodu  
Ordering Code  
Bestell-Bezeichnung

Stok Stock Lager	Takım Ölçüleri (mm) Dimension (mm) Abmessung (mm)					Kesici Uç Insert Wendeschneidplatte	Yedek Parçaları / Spare Parts / Ersatzteile									
	R	L	HF=H	B	LF		WF	Levyeye Lever Kniehebel	Levyeye Vidası Lever Screw Kniehehelschraube	Altılık Shim Unterlage	Altılık Yayını Shim Spring Feder für Unterlage	Oring Ring Feder	Sızdırmaz Vida Threaded Pin Gewindestift	Nozzle Nozzle Nozzle	Anahtar Allen Key Innerschlüssel	
● ●			20	20	125	25		APL-02	ALV-03-M8x19	AAWN-3-0001	AAAY-02	AXR-01 AOR-01	2705-G1/8x5.5	AN-01	AAL-03-3	
● ●			25	25	150	32										WNM. 0804..

R: Sağ / Right / Rechts L: Sol/Left/Links

● Stokta / In Stock / Auf Lager ○ Stokta Yok / Non Stock Item / Kein Lagerartikel, Lieferzeit auf Anfrage

Sipariş Örneği/Ordering Example/Bestellbeispiel

1 ad./pcs./stück PDNNN 2525 M15-H

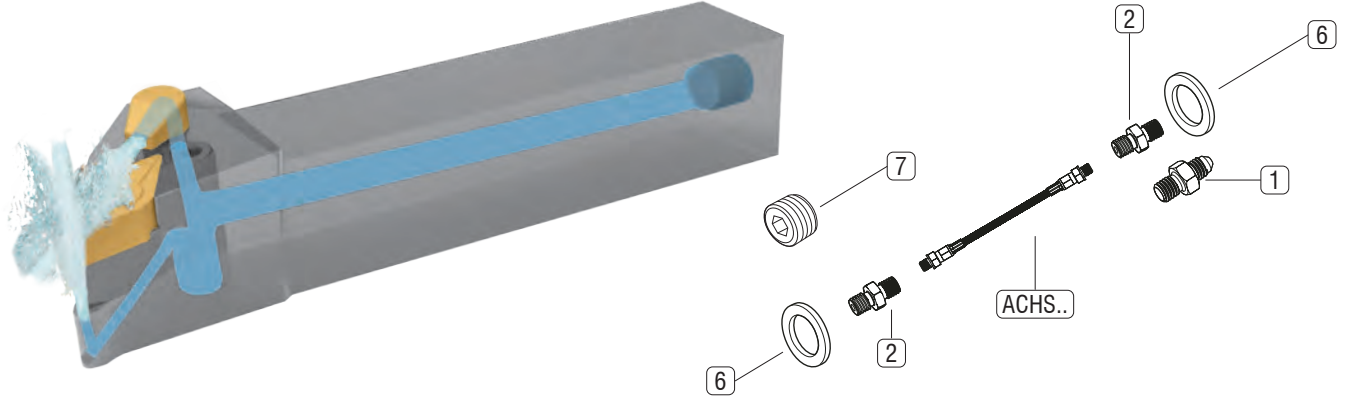

Not: İçten soğutmalı tüm torna katerlerinde kullanılabilecek 3 tip soğutma hortum setleri tasarlanmıştır. Takımların kullanılmasından önce, kullanılmayan bağlantıların set içindeki vida ile kapatılarak sızdırmazlığın sağlanmasına dikkat edilmelidir. Torna katerlerine yönelik soğutma hortum setleri, ACHS... 10 bar ile maksimum 275 bar basınç aralığında kullanılabilir.

Note: 3 types of cooling hose sets are designed that can be used in all internally cooled lathes. Before using the tools, care should be taken to ensure that the unused connections are closed with the screw in the set and that sealing is ensured. Cooling hose sets for lathe tools can be used in the pressure range of ACHS ... 10 bar to max 275 bar.

Notiz: Es wurden 3 Arten von Kühlschlauch-Sets entwickelt, die in allen intern gekühlten Drehmaschinen verwendet werden können. Vor der Verwendung der Werkzeuge sollte darauf geachtet werden, dass die nicht verwendeten Verbindungen mit der Schraube im Satz geschlossen werden und die Abdichtung gewährleistet ist. Kühlschlauchsätze für Drehmaschinen können im Druckbereich von ACHS ... 10 bar bis max. 275 bar eingesetzt werden.

Set İçindeki Parçalar Parts In The Set Teile im Set				Uzunluk / Length Code / Länge		
				Set Kodu: Set Code: Code Einstellen:	Set Kodu: Set Code: Code Einstellen:	Set Kodu: Set Code: Code Einstellen:
	Resim Picture Bild	Takım Kodu Set Code Code Einstellen	Ürün Açıklaması Product Description Artikelbeschreibung	ACHS-1-250	ACHS-2-250	ACHS-3-250
1		AMP-01	M10 Bağlantı Elemanı M10 Fastener M10 Verschluss	1x	-	-
2		AMP-02	G 1/8" Çift Bağlantı Elemanı G 1/8" Double Fastener G 1/8" Doppelverschluss	2x	1x	-
3		AMP-03	G 1/8" Açılı Bağlantısı G 1/8" Angle Connection G 1/8" Winkelverbindung	-	1x	2x
4		AMP-04	M10" Açılı Bağlantısı M10" Angle Connection M10" Winkelverbindung	-	1x	1x
5		AMP-05	G1/4"-G1/8" Kılcalma Parçası G1 / 4"-G1/8" Capillary Piece G1 / 4"-G1/8" Kapillarstück	-	1x	1x
6		AG-01	Bakır Conta Copper Gasket Kupferdichtung	2x	3x	4x
7		2705-G1/8-5.5	G1/8" Sızdırmaz Civata G1/8" Sealing Bolt G1/8" Dichtungsschraube	1x	1x	1x
8		AH-1-250	Hortum Hose Schlauch	1x	-	-
9		AH-2-250	Hortum Hose Schlauch	-	1x	-
10		AH-3-250	Hortum Hose Schlauch	-	-	1x

# C-SİSTEM

**C-SİSTEM DIŞ TORNA KATERLERİ**  
C-SYSTEM EXTERNAL TURNING TOOLHOLDERS  
C-SYSTEM AUSSEN - DREHHALTER

*konuşulan*  
*the spoken kalite...*  
*quality...*



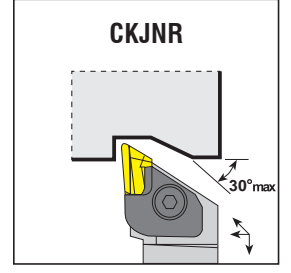
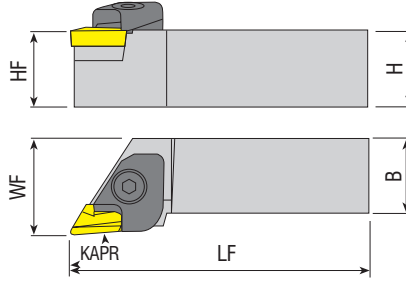

**Takım Kodu**  
**Ordering Code**  
**Bestell-Bezeichnung**

Stok Stock Lager		Takım Ölçüleri (mm) Dimension (mm) Abmessung (mm)				Kesici Uç Insert Wendeschneidplatte	Baskı Pabuçu Wedge Clamp Spannpratze	Pabuç Vidası Clamp Screw Klemmschraube	Altlık Shim Unterlage	Altlık Vidası Shim Screw Schraube für Unterlage	Yay Spring Feder	Pul Stamp Ring	Anahtar Allen Key Innerschloßschlüssel
R	L	HF=H	B	LF	WF								
●	●	20	20	125	27.5	KNUX 1604..	ACK-01-R	AKV-06-M16x20	AKS-16-R	AAV-01-M3x10	AKY-02	ABPL-01	AAL-05-4
●	●	25	25	150	31.5		ACK-02-L		AKS-16-L				
●	●	32	32	170	40								
●	●	40	40	250	50								

Yedek Parçaları / Spare Parts / Ersatzteile

R: Sağ / Right / Rechts L: Sol/Left/Links

● Stokta / In Stock / Auf Lager ○ Stokta Yok / Non Stock Item / Kein Lagerartikel, Lieferzeit auf Anfrage

Sipariş Örneği/Ordering Example/Bestellbeispiel

1 ad./pcs./stück CKJNR 2020 K16





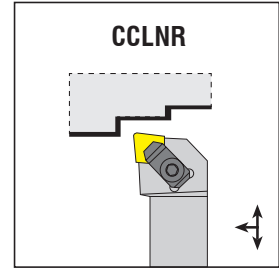
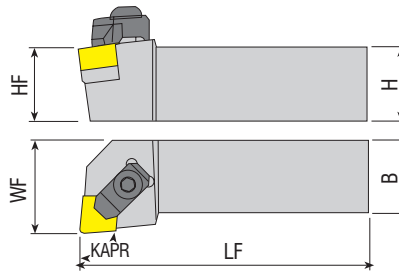

**Takım Kodu**  
**Ordering Code**  
**Bestell-Bezeichnung**

Stok Stock Lager	Takım Ölçüleri (mm) Dimension (mm) Abmessung (mm)						Kesici Uç Insert Wendescheidplatte	Yedek Parçaları / Spare Parts / Ersatzteile						
	R	L	HF=H	B	LF	WF		Baskı Pabucu Wedge Clamp Spannpratze	Pabuç Vidası Clamp Screw Klemmschraube	Altlık Shim Unterlage	Altlık Vidası Shim Screw Schraube für Unterlage	Sekman Ring Feder	Anahtar Allen Key Innensechskantschlüssel	
	●	●	25	25	150	32								
<b>CCLNR/L 2525 M1207C</b>	●	●	25	25	150	32	<b>CN.N 1207..</b>	ACK-13	AKV-11-M8x29	AACN-3-0001	AAV-02-M5x12	ACS-01	AAL-05-4	
<b>3232 P1207C</b>	●	●	32	32	170	40								
<b>2525 M1607C</b>	●	●	25	25	150	32	<b>CN.N 1607..</b>	ACK-13	AKV-11-M8x29	AACN-3-0002	AAV-05-M6x15	ACS-01	AAL-05-4	

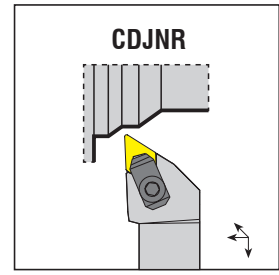
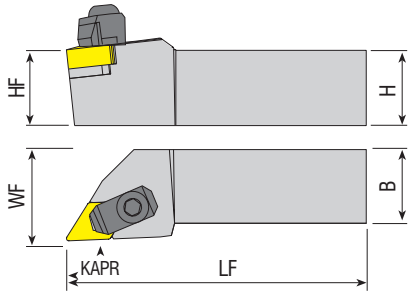

**Takım Kodu**  
**Ordering Code**  
**Bestell-Bezeichnung**

Stok Stock Lager	Takım Ölçüleri (mm) Dimension (mm) Abmessung (mm)						Kesici Uç Insert Wendescheidplatte	Yedek Parçaları / Spare Parts / Ersatzteile						
	R	L	HF=H	B	LF	WF		Baskı Pabucu Wedge Clamp Spannpratze	Pabuç Vidası Clamp Screw Klemmschraube	Altlık Shim Unterlage	Altlık Vidası Shim Screw Schraube für Unterlage	Sekman Ring Feder	Anahtar Allen Key Innensechskantschlüssel	
	●	●	25	25	150	32								
<b>CDJNR/L 2525 M1107C</b>	●	●	25	25	150	32	<b>DN.N 1107..</b>	ACK-22	AKV-11-M8x29	AADN-2-0001	AAV-04-M5x12	ACS-01	AAL-05-4	
<b>2525 M1507C</b>	●	●	25	25	150	32								
<b>3232 P1507C</b>	●	●	32	32	170	40	<b>DN.N 1507..</b>	ACK-13	AKV-11-M8x29	AADN-3-0001	AAV-02-M5x12	ACS-01	AAL-05-4	

R: Sağ / Right / Rechts L: Sol/Left/Links

● Stokta / In Stock / Auf Lager ○ Stokta Yok / Non Stock Item / Kein Lagerartikel, Lieferzeit auf Anfrage

Sipariş Örneği/Ordering Example/Bestellbeispiel  
1 ad./pcs./stück CCLNR 2525 M1207C

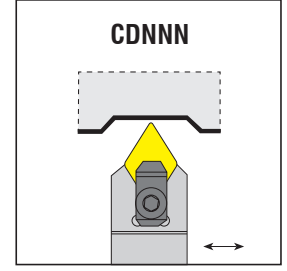
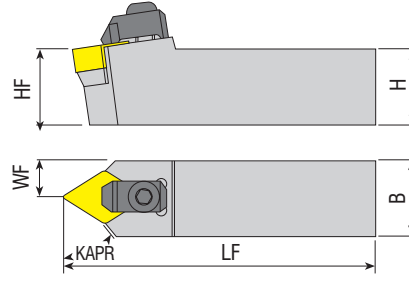

Takım Kodu Ordering Code Bestell-Bezeichnung	Stok Stock Lager	Takım Ölçüleri (mm) Dimension (mm) Abmessung (mm)				Kesici Uç Insert Wendeschneidplatte	Yedek Parçaları / Spare Parts / Ersatzteile					
		HF=H	B	LF	WF		Baskı Pabucu Wedge Clamp Spannpratze	Pabuç Vidası Clamp Screw Klemmschraube	Altlık Shim Unterlage	Altlık Vidası Shim Screw Schraube für Unterlage	Sekman Ring Feder	Anahtar Allen Key Innerschlüsselschlüssel
CDNNN 2525 M1107C	●	25	25	150	12.5	DN.N 1107..	ACK-22	AKV-11-M8x29	AADN-2-0001	AAV-04-M5x12	ACS-01	AAL-05-4

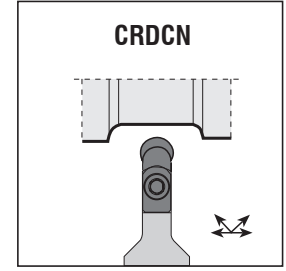
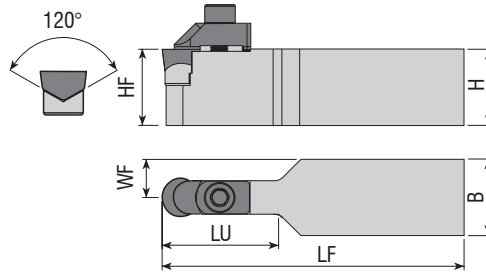

Takım Kodu Ordering Code Bestell-Bezeichnung	Stok Stock Lager	Takım Ölçüleri (mm) Dimension (mm) Abmessung (mm)					Kesici Uç Insert Wendeschneidplatte	Yedek Parçaları / Spare Parts / Ersatzteile				
		HF=H	B	LF	LU	WF		Baskı Pabucu Wedge Clamp Spannpratze	Pabuç Vidası Clamp Screw Klemmschraube	Altlık Shim Unterlage	Altlık Vidası Shim Screw Schraube für Unterlage	Anahtar Allen Key Innerschlüsselschlüssel
CRDCN 2525 M06CV	●	25	25	150	19	12.5	RCGX 0606..	ACK-27	2525-M3X14	AARC-3-0001	3007-M2.2X5	AAL-02-2.5
3225 P06CV	●	32	25	170	19	12.5						
4040 S06CV	●	40	40	250	19	20						
2525 M09CV	●	25	25	150	29	12.5	RCGX 0907..	ACK-28	2504-M5X16	AARC-3-0002	3008-M2.5x6	AAL-05-4
3225 P09CV	●	32	25	170	29	12.5						
4040 S09CV	●	40	40	250	29	20						
2525 M12CV	●	25	25	150	38	12.5	RCGX 1207..	ACK-29	2505-M6X20	AARC-3-0003	3008-M2.5x6	AAL-07-5
3225 P12CV	●	32	25	170	38	12.5						
4040 S12CV	●	40	40	250	38	20						

R: Sağ / Right / Rechts L: Sol/Left/Links  
● Stokta / In Stock / Auf Lager ○ Stokta Yok / Non Stock Item / Kein Lagerartikel, Lieferzeit auf Anfrage

Sipariş Örneği/Ordering Example/Bestellbeispiel  
1 ad./pcs./stück CDNNN 2525 M1107C

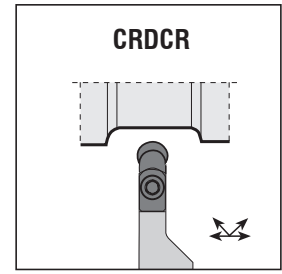
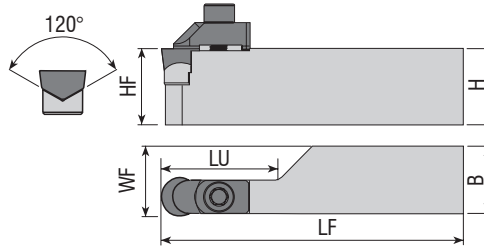

Takım Kodu Ordering Code Bestell-Bezeichnung	Stok Stock Lager		Takım Ölçüleri (mm) Dimension (mm) Abmessung (mm)				Kesici Uç Insert Wendeschneidplatte	Baskı Pabucu Wedge Clamp Spannpratze	Pabuç Vidası Clamp Screw Klemmschraube	Altlık Shim Unterlage	Altlık Vidası Shim Screw Schraube für Unterlage	Anahtar Allen Key Innerschloßschlüssel	
	R	L	HF=H	B	LF	LU							WF
<b>CRDCR/L 3225 P06CV</b>	●	●	32	25	170	19.4	25.6	<b>RCGX 060600</b>	ACK-27	2525-M3X14	AARC-3-0001	3007-M2.2X5	AAL-02-2.5
<b>3225 P09CV</b>	●	●	32	25	170	29	25.8	<b>RCGX 090700</b>	ACK-28	2504-M5X16	AARC-3-0002	3008-M2.5x6	AAL-05-4
<b>3225 P12CV</b>	●	●	32	25	170	38.5	25.9	<b>RCGX 120700</b>	ACK-29	2505-M6X20	AARC-3-0003	3008-M2.5x6	AAL-07-5

Yedek Parçaları / Spare Parts / Ersatzteile

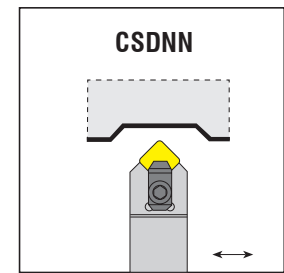
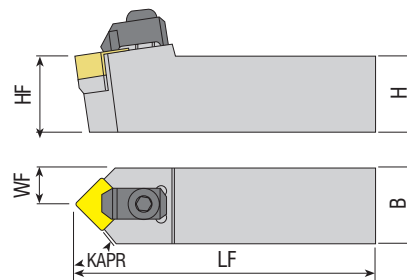
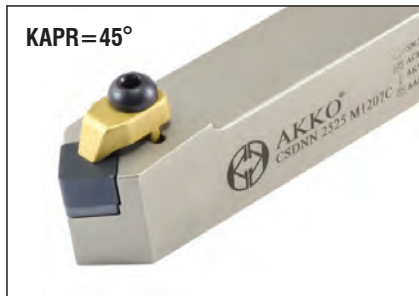

Takım Kodu Ordering Code Bestell-Bezeichnung	Stok Stock Lager		Takım Ölçüleri (mm) Dimension (mm) Abmessung (mm)				Kesici Uç Insert Wendeschneidplatte	Baskı Pabucu Wedge Clamp Spannpratze	Pabuç Vidası Clamp Screw Klemmschraube	Altlık Shim Unterlage	Altlık Vidası Shim Screw Schraube für Unterlage	Sekman Ring Feder	Anahtar Allen Key Innerschloßschlüssel
	HF=H	B	LF	WF									
<b>CSDNN 2525 M1207C</b>	●		25	25	150	12.5	<b>SN.N 1207..</b>	ACK-13	AKV-11-M8x29	AASN-3-0004	AAV-02-M5x12	ACS-01	AAL-05-4
<b>3232 P1207C</b>	●		32	32	170	16							

Yedek Parçaları / Spare Parts / Ersatzteile

R: Sağ / Right / Rechts L: Sol/Left/Links

● Stokta / In Stock / Auf Lager ○ Stokta Yok / Non Stock Item / Kein Lagerartikel, Lieferzeit auf Anfrage

Sipariş Örneği/Ordering Example/Bestellbeispiel

1 ad./pcs./stück CRDCR 3225 P06CV

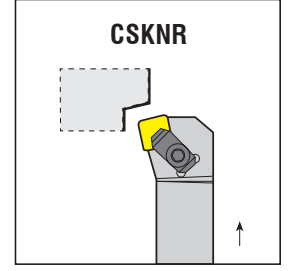
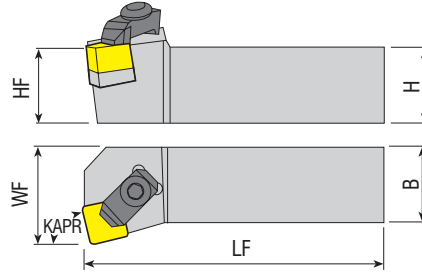

**Takım Kodu**  
**Ordering Code**  
**Bestell-Bezeichnung**

Stok Stock Lager		Takım Ölçüleri (mm) Dimension (mm) Abmessung (mm)					Kesici Uç Insert Wendeschneidplatte	Yedek Parçaları / Spare Parts / Ersatzteile					
		R	L	HF=H	B	LF		WF	Baskı Pabucu Wedge Clamp Spannpratze	Pabuç Vidası Clamp Screw Klemmschraube	Altılık Shim Unterlage	Altılık Vidası Shim Screw Schraube für Unterlage	Sekman Ring Feder
●	●	25	25	150	32	SN.N 1207..							
●	●	32	32	170	40								

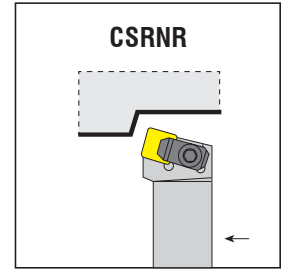
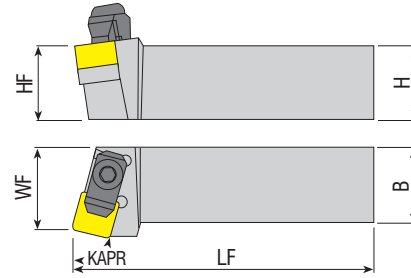

**Takım Kodu**  
**Ordering Code**  
**Bestell-Bezeichnung**

Stok Stock Lager		Takım Ölçüleri (mm) Dimension (mm) Abmessung (mm)					Kesici Uç Insert Wendeschneidplatte	Yedek Parçaları / Spare Parts / Ersatzteile					
		R	L	HF=H	B	LF		WF	Baskı Pabucu Wedge Clamp Spannpratze	Pabuç Vidası Clamp Screw Klemmschraube	Altılık Shim Unterlage	Altılık Vidası Shim Screw Schraube für Unterlage	Sekman Ring Feder
●	●	25	25	150	32	SN.N 1207..							
●	●	32	32	170	40								

R: Sağ / Right / Rechts L: Sol/Left/Links

● Stokta / In Stock / Auf Lager ○ Stokta Yok / Non Stock Item / Kein Lagerartikel, Lieferzeit auf Anfrage

Sipariş Örneği/Ordering Example/Bestellbeispiel

1 ad./pcs./stück C-SKNR 2525 M1207C



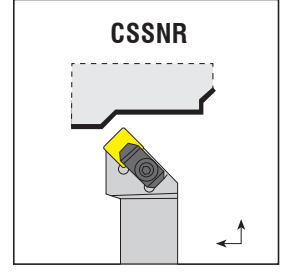
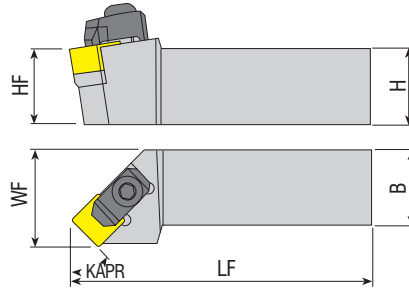

Takım Kodu Ordering Code Bestell-Bezeichnung	Stok Stock Lager		Takım Ölçüleri (mm) Dimension (mm) Abmessung (mm)				Kesici Uç Insert Wendeschneidplatte	Yedek Parçaları / Spare Parts / Ersatzteile					
	R	L	HF=H	B	LF	WF		Baskı Pabucu Wedge Clamp Spannpratze	Pabuç Vidası Clamp Screw Klemmschraube	Altlık Shim Unterlage	Altlık Vidası Shim Screw Schraube für Unterlage	Sekman Ring Feder	Anahtar Allen Key Innerschloßschlüssel
CSSNR/L 2525 M1207C	●	●	25	25	150	32	SN.N 1207..	ACK-13	AKV-11-M8x29	AASN-3-0004	AAV-02-M5x12	ACS-01	AAL-05-4
3232 P1207C	●	●	32	32	170	40							

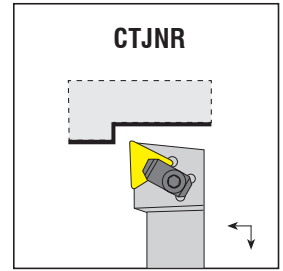
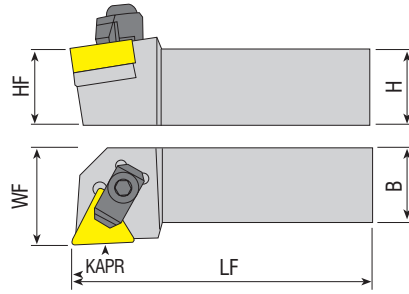
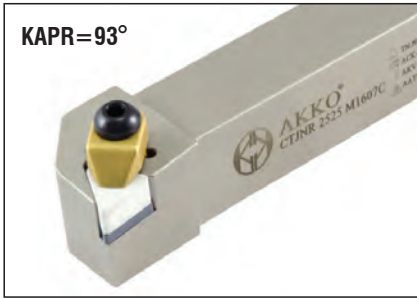

Takım Kodu Ordering Code Bestell-Bezeichnung	Stok Stock Lager		Takım Ölçüleri (mm) Dimension (mm) Abmessung (mm)				Kesici Uç Insert Wendeschneidplatte	Yedek Parçaları / Spare Parts / Ersatzteile					
	R	L	HF=H	B	LF	WF		Baskı Pabucu Wedge Clamp Spannpratze	Pabuç Vidası Clamp Screw Klemmschraube	Altlık Shim Unterlage	Altlık Vidası Shim Screw Schraube für Unterlage	Sekman Ring Feder	Anahtar Allen Key Innerschloßschlüssel
CTJNR/L 2525 M1607C	●	●	25	25	150	32	TN.N 1607..	ACK-14	AKV-11-M8x29	AATN-2-0002	AAV-03-M5x12	ACS-01	AAL-05-4
3232 P1607C	○	○	32	32	170	40							

R: Sağ / Right / Rechts L: Sol/Left/Links

● Stokta / In Stock / Auf Lager ○ Stokta Yok / Non Stock Item / Kein Lagerartikel, Lieferzeit auf Anfrage

Sipariş Örneği/Ordering Example/Bestellbeispiel  
1 ad./pcs./stück CSSNR 2525 M1207C



*konusulan  
the spoken kalite...  
quality...*

# S-SİSTEM

**S-SİSTEM DIŞ TORNA KATERLERİ**  
S-SYSTEM EXTERNAL TURNING TOOLHOLDERS  
S-SYSTEM AUSSEN - DREHHALTER



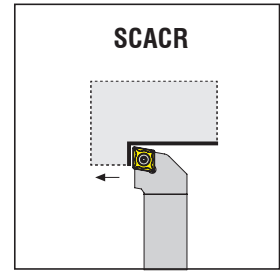
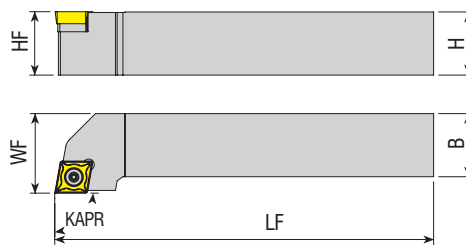
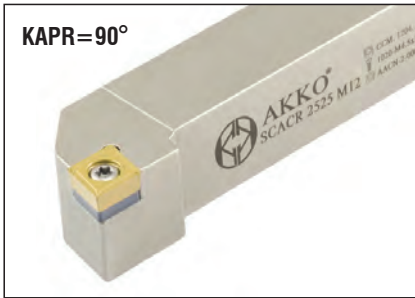

**Takım Kodu**  
**Ordering Code**  
**Bestell-Bezeichnung**

Stok  
Stock  
Lager

Takım Ölçüleri (mm)  
Dimension (mm)  
Abmessung (mm)

Kesici Uç  
Insert  
Wendeschneidplatte

Sıkma Vidası  
Screw  
Schraube

Altlık  
Shim  
Unterlage

Altlık Vidası  
Shim Screw  
Schraube für Unterlage

Tork Anahtar  
Torx Key  
Torx-Schlüssel

R L HF=H B LF WF



SCACR/L 0808 E06  
1010 E06  
1212 F09  
1616 H09  
2020 K09  
2020 K12  
2525 M12

● ● 08 08 70 10  
● ● 10 10 70 12  
● ● 12 12 80 16  
● ● 16 16 100 20  
● ● 20 20 125 25  
● ● 20 20 125 25  
● ● 25 25 150 32

CCM. 0602..

4008-M2.5x6

-

-

80-T08

CC.T 09T3..

4015-M3.5x11

-

-

4015-M3.5x14

AACN-2-0001

AAV-06-M3.5x11

80-T15

CC.T 1204..

1020-M4.5x16

AACN-2-0003

AAV-07-M4.5x13

80-T20

Yedek Parçaları / Spare Parts / Ersatzteile

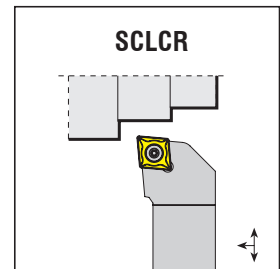
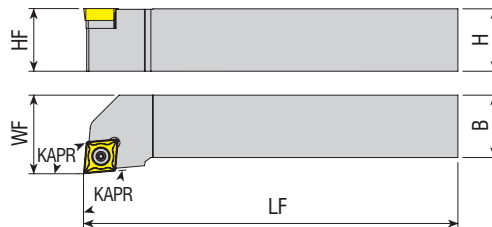
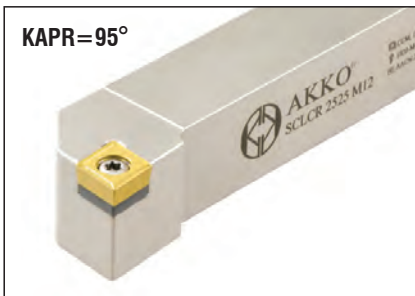

**Takım Kodu**  
**Ordering Code**  
**Bestell-Bezeichnung**

Stok  
Stock  
Lager

Takım Ölçüleri (mm)  
Dimension (mm)  
Abmessung (mm)

Kesici Uç  
Insert  
Wendeschneidplatte

Sıkma Vidası  
Screw  
Schraube

Altlık  
Shim  
Unterlage

Altlık Vidası  
Shim Screw  
Schraube für Unterlage

Tork Anahtar  
Torx Key  
Torx-Schlüssel

R L HF=H B LF WF



SCLCR/L 0808 E06  
1010 E06  
1212 F06  
1010 E09  
1212 F09  
1616 H09  
2020 K09  
2525 M09  
1616 H12  
2020 K12  
2525 M12

● ● 08 08 70 10  
● ○ 10 10 70 12  
● ● 12 12 80 16  
● ● 10 10 70 12  
● ● 12 12 80 16  
● ● 16 16 100 20  
● ● 20 20 125 25  
● ● 25 25 150 32  
● ○ 16 16 100 20  
● ● 20 20 125 25  
● ● 25 25 150 32

CCM. 0602..

4008-M2.5x6

-

-

80-T08

CC.T 09T3..

4015-M3x9

-

-

4015-M3.5x11

-

-

4015-M3.5x14

AACN-2-0001

AAV-06-M3.5x11

80-T15

CC.T 1204..

1020-M5x11

-

-

1020-M4.5x16

AACN-2-0003

AAV-07-M4.5x13

80-T20

Yedek Parçaları / Spare Parts / Ersatzteile

R: Sağ / Right / Rechts L: Sol/Left/Links

● Stokta / In Stock / Auf Lager ○ Stokta Yok / Non Stock Item / Kein Lagerartikel, Lieferzeit auf Anfrage

Sipariş Örneği/Ordering Example/Bestellbeispiel

1 ad./pcs./stück SCACR 0808 E06

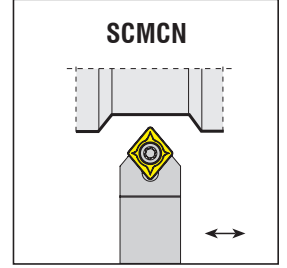
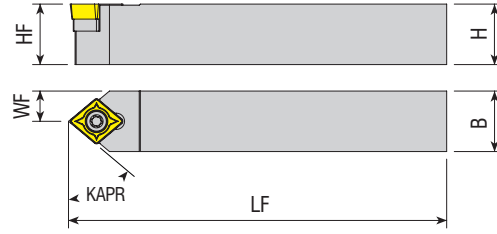

**Takım Kodu**  
**Ordering Code**  
**Bestell-Bezeichnung**

Stok Stock Lager	Takım Ölçüleri (mm) Dimension (mm) Abmessung (mm)				Kesici Uç Insert Wendeschneidplatte	Yedek Parçaları / Spare Parts / Ersatzteile				
	HF=H	B	LF	WF		Sıkma Vidası Screw Schraube	Altlık Shim Unterlage	Altlık Vidası Shim Screw Schraube für Unterlage	Tork Anahtar Torx Key Torx-Schlüssel	
SCMCN 0808 E06	●	08	08	70	04	CCM. 0602..	4008-M2.5x6	-	-	80-T08
1010 E06	●	10	10	70	05					
1212 F06	●	12	12	80	06					
1212 F09	●	12	12	80	06	CC.T 09T3..	4015-M3.5x11 4015-M3.5x14	AACN-2-0001	AAV-06-M3.5x11	80-T15
1616 H09	●	16	16	100	08					
2020 K12	●	20	20	125	10	CC.T 1204..	1020-M4.5x16	AACN-2-0003	AAV-07-M4.5x13	80-T20
2525 M12	●	25	25	150	12.5					

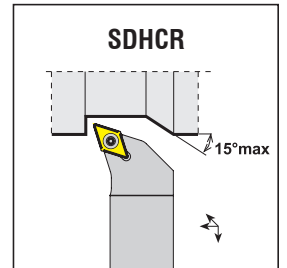
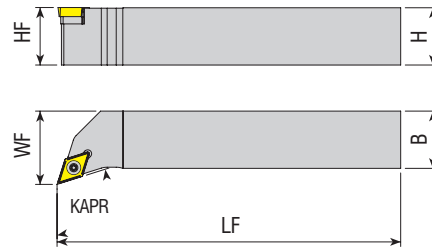

**Takım Kodu**  
**Ordering Code**  
**Bestell-Bezeichnung**

Stok Stock Lager	Takım Ölçüleri (mm) Dimension (mm) Abmessung (mm)				Kesici Uç Insert Wendeschneidplatte	Yedek Parçaları / Spare Parts / Ersatzteile					
	R	L	HF=H	B		LF	WF	Sıkma Vidası Screw Schraube	Altlık Shim Unterlage	Altlık Vidası Shim Screw Schraube für Unterlage	Tork Anahtar Torx Key Torx-Schlüssel
SDHCR/L 0808 E07	●	●	08	08	70	11	DC.T 0702..	4008-M2.5x6	-	-	80-T08
1010 E07	●	●	10	10	70	12					
1212 F07	●	●	12	12	80	16					
1616 H07	●	●	16	16	100	20					
1616 H11	●	●	16	16	100	20	DC.T 11T3..	4015-M3.5x14	AADN-2-0001	AAV-06-M3.5x11	80-T15
2020 K11	●	●	20	20	125	25					
2525 M11	●	●	25	25	150	32					
3232 P11	●	●	32	32	170	40					

R: Sağ / Right / Rechts L: Sol/Left/Links

● Stokta / In Stock / Auf Lager ○ Stokta Yok / Non Stock Item / Kein Lagerartikel, Lieferzeit auf Anfrage

Sipariş Örneği/Ordering Example/Bestellbeispiel

1 ad./pcs./stück SCMCN 0808 E06



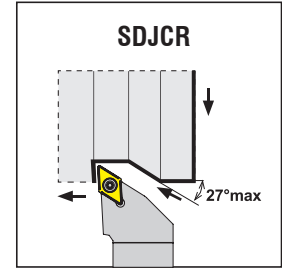
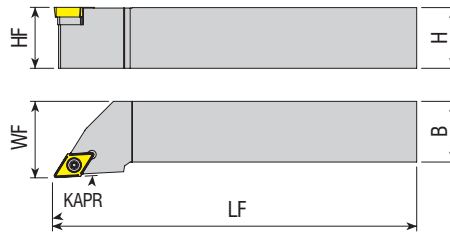
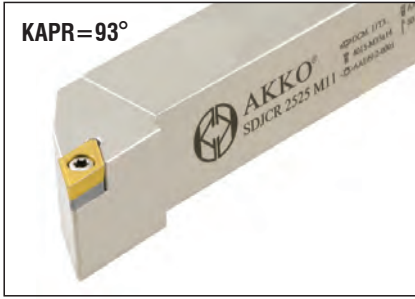

Takım Kodu Ordering Code Bestell-Bezeichnung	Stok Stock Lager		Takım Ölçüleri (mm) Dimension (mm) Abmessung (mm)				Kesici Uç Insert Wendeschneidplatte	Yedek Parçaları / Spare Parts / Ersatzteile			
	R	L	HF=H	B	LF	WF		Sıkma Vidası Screw Schraube	Altık Shim Unterlage	Altık Vidası Shim Screw Schraube für Unterlage	Tork Anahtar Torx Key Torx-Schlüssel
SDJCR/L 0808 E07	●	●	08	08	70	10	DC.T 0702..	4008-M2.5x6	-	-	80-T08
1010 E07	●	●	10	10	70	12					
1212 F07	●	●	12	12	80	16					
1616 H07	●	●	16	16	100	20					
1616 H11	●	●	16	16	100	20	DC.T 11T3..	4015-M3.5x14	AADN-2-0001	AAV-06-M3.5x11	80-T15
2020 K11	●	●	20	20	125	25					
2525 M11	●	●	25	25	150	32					
3232 P11	●	●	32	32	170	40					

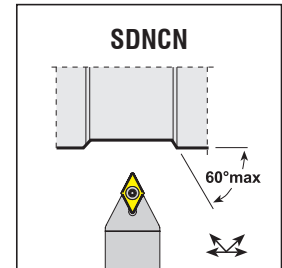
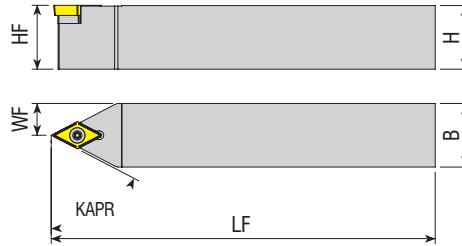
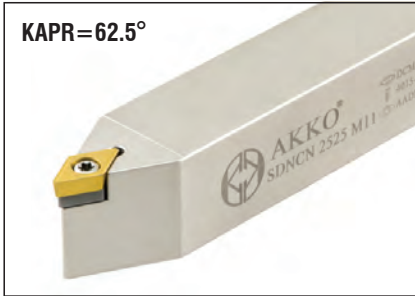

Takım Kodu Ordering Code Bestell-Bezeichnung	Stok Stock Lager		Takım Ölçüleri (mm) Dimension (mm) Abmessung (mm)				Kesici Uç Insert Wendeschneidplatte	Yedek Parçaları / Spare Parts / Ersatzteile			
	R	L	HF=H	B	LF	WF		Sıkma Vidası Screw Schraube	Altık Shim Unterlage	Altık Vidası Shim Screw Schraube für Unterlage	Tork Anahtar Torx Key Torx-Schlüssel
SDNCN 0808 E07	●		08	08	70	4	DC.T 0702..	4008-M2.5x6	-	-	80-T08
1010 E07	●		10	10	70	5					
1212 F07	●		12	12	80	6					
1616 H07	●		16	16	100	8					
1616 H11	●		16	16	100	8	DC.T 11T3..	4015-M3.5x14	AADN-2-0001	AAV-06-M3.5x11	80-T15
2020 K11	●		20	20	125	10					
2525 M11	●		25	25	150	12.5					
3232 P11	●		32	32	170	16					

R: Sağ / Right / Rechts L: Sol/Left/Links  
● Stokta / In Stock / Auf Lager ○ Stokta Yok / Non Stock Item / Kein Lagerartikel, Lieferzeit auf Anfrage

Sipariş Örneği/Ordering Example/Bestellbeispiel  
1 ad./pcs./stück SDJCR 0808 E07

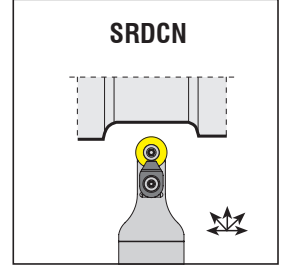
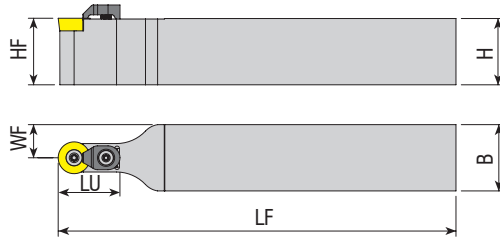

**Takım Kodu**  
**Ordering Code**  
**Bestell-Bezeichnung**

Takım Kodu Ordering Code Bestell-Bezeichnung	Stok Stock Lager	Takım Ölçüleri (mm) Dimension (mm) Abmessung (mm)					Kesici Uç Insert Wendeschneidplatte	Yedek Parçaları / Spare Parts / Ersatzteile								
		HF=H	B	LF	LU	WF		Sıkma Vidası Screw Schraube	Altlık Shim Unterlage	Altlık Vidası Shim Screw Schraube für Unterlage	Baskı Parçası Wedge Clamp Spannpratze	Baskı Vidası Clamp Screw Klemmschraube	Tork Anahtar Torx Key Torx-Schlüssel			
<b>SRDCN 1616 H06</b>	●	16	16	100	15	8										
<b>2020 K06</b>	●	20	20	125	17	10	<b>RC.T 0602..</b>	3008-M2.5x6	-	-	-	-				
<b>2525 M06</b>	●	25	25	150	17	12.5										
<b>1616 H08C</b>	●	16	16	100	15	8										80-T08
<b>2020 K08C</b>	●	20	20	125	20	10	<b>RC.T 0803..</b>	3008-M3x8	-	-						
<b>2525 M08C</b>	●	25	25	150	20	12.5										
<b>1616 H10C</b>	●	16	16	100	20	8						ACK-15	4015-M3.5x11			
<b>2020 K10C</b>	●	20	20	125	20	10	<b>RC.T 10T3..</b>	4015-M3.5x11	-	-						
<b>2525 M10C</b>	●	25	25	150	20	12.5										
<b>3232 P10C</b>	●	32	32	170	20	16										
<b>2020 K12C</b>	●	20	20	125	22	10										80-T15
<b>2525 M12C</b>	●	25	25	150	22	12.5	<b>RC.T 1204..</b>	4015-M3.5x11	-	-						
<b>3232 P12C</b>	●	32	32	170	22	16										
<b>2525 M16C</b>	●	25	25	150	32	12.5						ACK-05	4015-M4x11			
<b>3232 P16C</b>	●	32	32	170	35	16	<b>RC.T 1605..</b>	1020-M5x11	-	-						
<b>2525 M20C</b>	●	25	25	150	32	12.5										
<b>3232 P20C</b>	●	32	32	170	40	16	<b>RC.T 2006..</b>	1420-M6x16	-	-						
<b>3232 P25C</b>	●	32	32	170	40	16	<b>RC.T 2507..</b>	1520-M6x16	-	-			ACK-09	AAV-05-M6x15		
<b>3232 P32C</b>	●	32	32	170	45	16	<b>RC.T 3209..</b>	1904-M8x1x20								

R: Sağ / Right / Rechts L: Sol/Left/Links

● Stokta / In Stock / Auf Lager ○ Stokta Yok / Non Stock Item / Kein Lagerartikel, Lieferzeit auf Anfrage

Sipariş Örneği/Ordering Example/Bestellbeispiel

1 ad./pcs./stück SRDCN 1616 H06



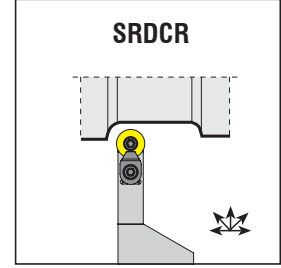
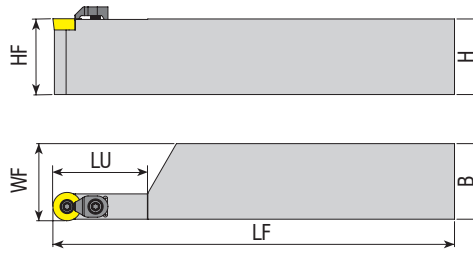

**Takım Kodu**  
**Ordering Code**  
**Bestell-Bezeichnung**

Stok Stock Lager	Takım Ölçüleri (mm) Dimension (mm) Abmessung (mm)						Kesici Uç Insert Wendeschneidplatte	Yedek Parçaları / Spare Parts / Ersatzteile						
	R	L	HF=H	B	LF	LU		WF	Sıkma Vidası Screw Schraube	Altlık Shim Unterlage	Altlık Vidası Shim Screw Schraube für Unterlage	Baskı Parçası Wedge Clamp Spannpratze	Baskı Vidası Clamp Screw Klemmschraube	Tork Anahtar Torx Key Torx-Schlüssel
SRDCR/L 3232 T06	●	●	32	32	300	20	32.35	RC.T 0602..	3008-M2.5x6	-	-	-	-	80-T08
3232 P12C	●	●	32	32	170	40	32.65	RC.T 1204..	4015-M3.5x11			ACK-05	4015-M4x11	80-T15

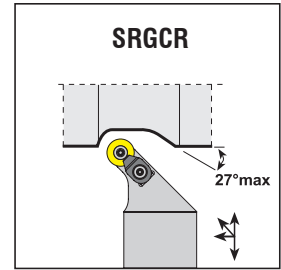
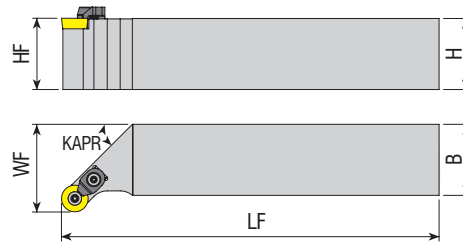

**Takım Kodu**  
**Ordering Code**  
**Bestell-Bezeichnung**

Stok Stock Lager	Takım Ölçüleri (mm) Dimension (mm) Abmessung (mm)						Kesici Uç Insert Wendeschneidplatte	Yedek Parçaları / Spare Parts / Ersatzteile					
	R	L	HF=H	B	LF	WF		Sıkma Vidası Screw Schraube	Altlık Shim Unterlage	Altlık Vidası Shim Screw Schraube für Unterlage	Baskı Parçası Wedge Clamp Spannpratze	Baskı Vidası Clamp Screw Klemmschraube	Tork Anahtar Torx Key Torx-Schlüssel
SRGCR/L 1616 H06	●	●	16	16	100	20	RC.T 0602..	3008-M2.5x6	-	-	-	-	80-T08
2020 K06	●	●	20	20	125	25							
1616 H08C	●	●	16	16	100	20	RC.T 0803..	3008-M3x8	-	-	-	-	
2020 K08C	●	●	20	20	125	25							
2525 M08C	●	●	25	25	150	32	RC.T 10T3..	4015-M3.5x11	-	-	ACK-15	4015-M3.5x11	
1616 H10C	●	●	16	16	100	20							
2020 K10C	●	●	20	20	125	25							
2525 M10C	●	●	25	25	150	32							
3232 P10C	●	●	32	32	170	40	RC.T 1204..	4015-M3.5x11	-	-	ACK-05	4015-M4x11	80-T15
2020 K12C	●	●	20	20	125	25							
2525 M12C	●	●	25	25	150	32							
3232 P12C	●	●	32	32	170	40							

R: Sağ / Right / Rechts L: Sol/Left/Links

● Stokta / In Stock / Auf Lager ○ Stokta Yok / Non Stock Item / Kein Lagerartikel, Lieferzeit auf Anfrage

Sipariş Örneği/Ordering Example/Bestellbeispiel

1 ad./pcs./stück SRDCR 3232 T06

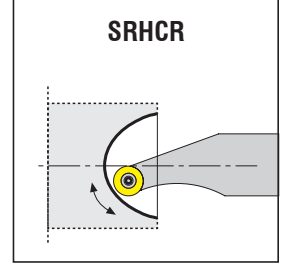
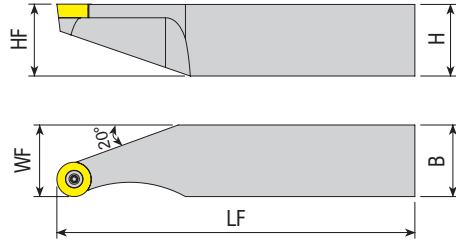

**Takım Kodu**  
**Ordering Code**  
**Bestell-Bezeichnung**

Stok Stock Lager	Takım Ölçüleri (mm) Dimension (mm) Abmessung (mm)						Kesici Uç Insert Wendeschneidplatte	Yedek Parçaları / Spare Parts / Ersatzteile				
	R	L	HF=H	B	LF	WF		Sıkma Vidası Screw Schraube	Altlık Shim Unterlage	Altlık Vidası Shim Screw Schraube für Unterlage	Tork Anahtar Torx Key Torx-Schlüssel	
SRHCR/L 2525 K06	●	○	25	25	125	25	32.5	RCM. 0602..	3008-M2.5x6	-	-	80-T08
2525 K08	●	●	25	25	125	25	32.5	RCM. 0803..	3008-M3x8	-	-	80-T08
2525 K10	●	●	25	25	125	25	36	RCM. 10T3..	4015-M3.5x11	-	-	80-T15
2525 K12	●	●	25	25	125	25	40	RCM. 1204..	-	-	-	80-T15
2525 K16	●	●	25	25	125	25	47.5	RCM. 1606..	1020-M5x11	-	-	80-T20

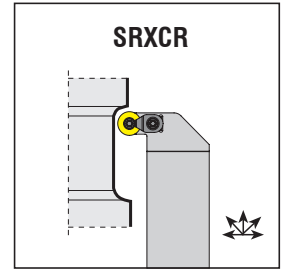
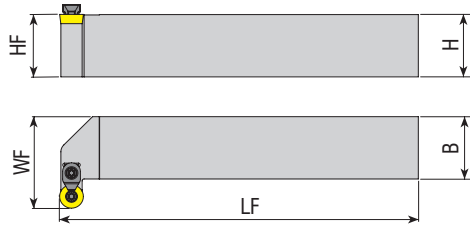

**Takım Kodu**  
**Ordering Code**  
**Bestell-Bezeichnung**

Stok Stock Lager	Takım Ölçüleri (mm) Dimension (mm) Abmessung (mm)						Kesici Uç Insert Wendeschneidplatte	Sıkma Vidası Screw Schraube	Altlık Shim Unterlage	Altlık Vidası Shim Screw Schraube für Unterlage	Baskı Parçası Wedge Clamp Spannpratze	Baskı Vidası Clamp Screw Klemmschraube	Tork Anahtar Torx Key Torx-Schlüssel
	R	L	HF=H	B	LF	WF					ACK-15	4015-M3.5x11	
SRXCR/L 3232 X08C	●	●	32	32	220	47	RC.T 0803..	3008-M3x8	-	-	ACK-15	4015-M3.5x11	80-T08
3232 X10C	●	●	32	32	220	47	RC.T 10T3..	4015-M3.5x11	-	-	ACK-15	4015-M3.5x11	80-T15
3232 X12C	●	●	32	32	220	47	RC.T 1204..	-	-	ACK-05	4015-M4x11	-	80-T15

R: Sağ / Right / Rechts L: Sol/Left/Links

● Stokta / In Stock / Auf Lager ○ Stokta Yok / Non Stock Item / Kein Lagerartikel, Lieferzeit auf Anfrage

Sipariş Örneği/Ordering Example/Bestellbeispiel

1 ad./pcs./stück SRHCR 2525 K06



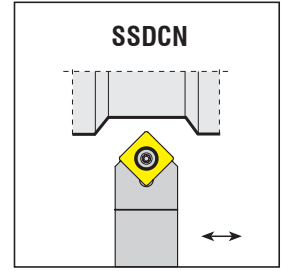
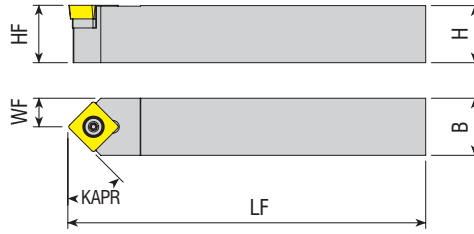

Takım Kodu Ordering Code Bestell-Bezeichnung	Stok Stock Lager		Takım Ölçüleri (mm) Dimension (mm) Abmessung (mm)				Kesici Uç Insert Wendeschneidplatte	Yedek Parçaları / Spare Parts / Ersatzteile				
	R	L	HF=H	B	LF	WF		Sıkma Vidası Screw Schraube	Altlık Shim Unterlage	Altlık Vidası Shim Screw Schraube für Unterlage	Tork Anahtar Torx Key Torx-Schlüssel	
												HF=H
SSDCN 1212 F09	●		12	12	80	6	SC.T 09T3..	4015-M3.5x11	-	-	80-T15	
1616 H09	●		16	16	100	8		4015-M3.5x14	AASN-2-0001	AAV-06-M3.5x11		
2020 K09	●		20	20	125	10		4020-M4.5x12		AAV-10-M4.5x8		
1616 H12	●		16	16	100	8	SC.T 1204..	1020-M4.5x16	AASN-2-0004	AAV-07-M4.5x13	80-T20	
2020 K12	●		20	20	125	10						
2525 M12	●		25	25	150	12.5						

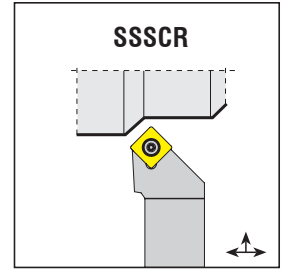
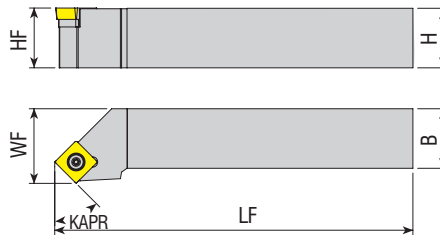
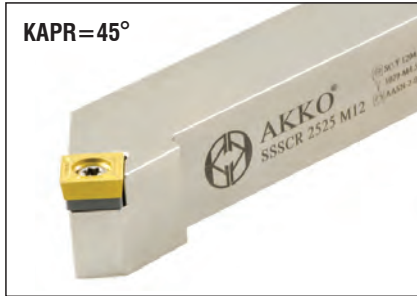

Takım Kodu Ordering Code Bestell-Bezeichnung	Stok Stock Lager		Takım Ölçüleri (mm) Dimension (mm) Abmessung (mm)				Kesici Uç Insert Wendeschneidplatte	Yedek Parçaları / Spare Parts / Ersatzteile				
	R	L	HF=H	B	LF	WF		Sıkma Vidası Screw Schraube	Altlık Shim Unterlage	Altlık Vidası Shim Screw Schraube für Unterlage	Tork Anahtar Torx Key Torx-Schlüssel	
												HF=H
SSSCR/L 1212 F09	●	●	12	12	80	16	SC.T 09T3..	4015-M3.5x11	-	-	80-T15	
1616 H09	●	●	16	16	100	20		4015-M3.5x14	AASN-2-0001	AAV-06-M3.5x11		
2020 K09	●	●	20	20	125	25		4020-M4.5x12		AAV-10-M4.5x8		
1616 H12	●	●	16	16	100	20	SC.T 1204..	1020-M4.5x16	AASN-2-0004	AAV-07-M4.5x13	80-T20	
2020 K12	●	●	20	20	125	25						
2525 M12	●	●	25	25	150	32						

R: Sağ / Right / Rechts L: Sol/Left/Links

● Stokta / In Stock / Auf Lager ○ Stokta Yok / Non Stock Item / Kein Lagerartikel, Lieferzeit auf Anfrage

Sipariş Örneği/Ordering Example/Bestellbeispiel

1 ad./pcs./stück SSDCN 1212 F09

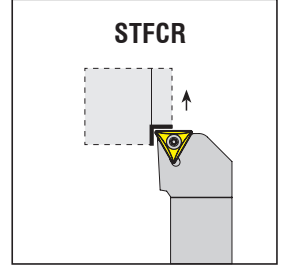
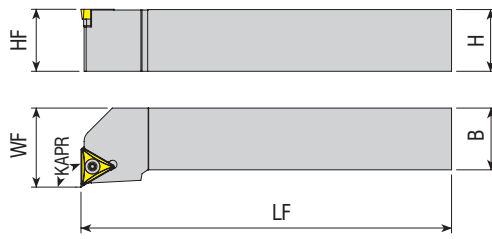

Takım Kodu Ordering Code Bestell-Bezeichnung	Stok Stock Lager		Takım Ölçüleri (mm) Dimension (mm) Abmessung (mm)				Kesici Uç Insert Wendeschneidplatte	Yedek Parçaları / Spare Parts / Ersatzteile				
	R	L	HF=H	B	LF	WF		Sıkma Vidası Screw Schraube	Altlık Shim Unterlage	Altlık Vidası Shim Screw Schraube für Unterlage	Tork Anahtar Torx Key Torx-Schlüssel	
STFGR/L 0808 E09	○	○	08	08	70	10	TC.T 0902..	3007-M2.2x5			80-T07	
1010 E09	●	●	10	10	70	12						
1212 F11	●	●	12	12	80	16	TC.T 1102..	4008-M2.5x6			80-T08	
1616 H11	●	●	16	16	100	20						
1616 H16	●	●	16	16	100	20	TC.T 16T3..	4015-M3.5x14	AATN-2-0001	AAV-06-M3.5x11	80-T15	
2020 K16	●	●	20	20	125	25						
2525 M16	●	●	25	25	150	32						
3232 P16	●	●	32	32	170	40						

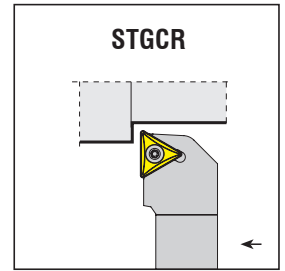
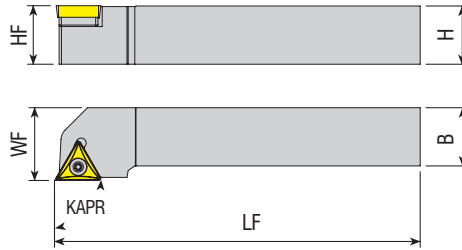

Takım Kodu Ordering Code Bestell-Bezeichnung	Stok Stock Lager		Takım Ölçüleri (mm) Dimension (mm) Abmessung (mm)				Kesici Uç Insert Wendeschneidplatte	Yedek Parçaları / Spare Parts / Ersatzteile				
	R	L	HF=H	B	LF	WF		Sıkma Vidası Screw Schraube	Altlık Shim Unterlage	Altlık Vidası Shim Screw Schraube für Unterlage	Tork Anahtar Torx Key Torx-Schlüssel	
STGCR/L 0808 E09	●	●	08	08	70	10	TC.T 0902..	3007-M2.2x5			80-T07	
1010 E09	●	●	10	10	70	12						
1212 F11	●	●	12	12	80	16	TC.T 1102..	4008-M2.5x6			80-T08	
1616 H11	●	●	16	16	100	20						
1616 H16	●	●	16	16	100	20	TC.T 16T3..	4015-M3.5x14	AATN-2-0001	AAV-06-M3.5x11	80-T15	
2020 K16	●	●	20	20	125	25						
2525 M16	●	●	25	25	150	32						
3232 P16	●	●	32	32	170	40						

R: Sağ / Right / Rechts L: Sol/Left/Links

● Stokta / In Stock / Auf Lager ○ Stokta Yok / Non Stock Item / Kein Lagerartikel, Lieferzeit auf Anfrage

Sipariş Örneği/Ordering Example/Bestellbeispiel

1 ad./pcs./stück STFGR 0808 E09

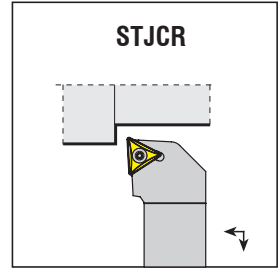
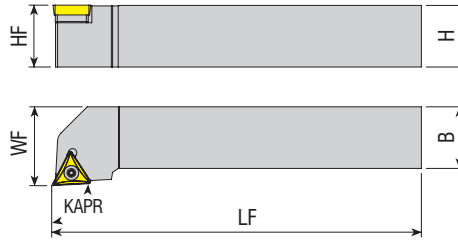
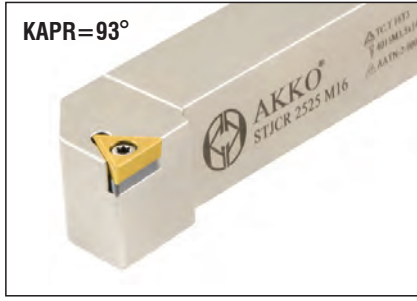

**Takım Kodu**  
**Ordering Code**  
**Bestell-Bezeichnung**

Stok  
Stock  
Lager

Takım Ölçüleri (mm)  
Dimension (mm)  
Abmessung (mm)

Kesici Uç  
Insert  
Wendeschneidplatte

Yedek Parçaları / Spare Parts / Ersatzteile

Sıkma Vidası  
Screw  
Schraube

Altık  
Shim  
Unterlage

Altık Vidası  
Shim Screw  
Schraube für Unterlage

Tork Anahtar  
Torx Key  
Torx-Schlüssel

R L

HF=H

B

LF

WF



STJCR/L 0808 E09

● ●

08

08

70

10

TC.T 0902..

3007-M2.2x5

-

-

80-T07

1010 E09

● ●

10

10

70

12

TC.T 1102..

4008-M2.5x6

1212 F11

● ●

12

12

80

16

1616 H11

● ●

16

16

100

20

1616 H16

● ●

16

16

100

20

2020 K16

● ●

20

20

125

25

2525 M16

● ●

25

25

150

32

3232 P16

● ●

32

32

170

40

TC.T 16T3..

4015-M3.5x14

AATN-2-0001

AAV-06-M3.5x11

80-T15

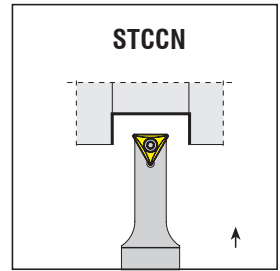
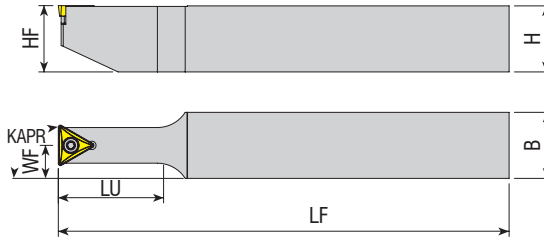

**Takım Kodu**  
**Ordering Code**  
**Bestell-Bezeichnung**

Stok  
Stock  
Lager

Takım Ölçüleri (mm)  
Dimension (mm)  
Abmessung (mm)

Kesici Uç  
Insert  
Wendeschneidplatte

Yedek Parçaları / Spare Parts / Ersatzteile

Sıkma Vidası  
Screw  
Schraube

Altık  
Shim  
Unterlage

Altık Vidası  
Shim Screw  
Schraube für Unterlage

Tork Anahtar  
Torx Key  
Torx-Schlüssel

HF=H

B

LF

WF

LU



STCCN 2020 L11

●

20

20

140

10

50

TC.T 1102..

4008-M2.5x6

-

-

80-T08

1616 K16

●

16

16

125

8

24

2020 M16

●

20

20

150

10

30

2525 P16

●

25

25

170

12.5

37.5

3232 R16

●

32

32

200

16

48

2525 P22

●

25

25

170

12.5

80

TC.T 2204..

4020-M4.5x12

-

-

80-T20

R: Sağ / Right / Rechts L: Sol/Left/Links

● Stokta / In Stock / Auf Lager ○ Stokta Yok / Non Stock Item / Kein Lagerartikel, Lieferzeit auf Anfrage

Sipariş Örneği/Ordering Example/Bestellbeispiel

1 ad./pcs./stück STJCR 0808 E09

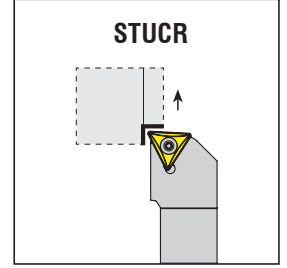
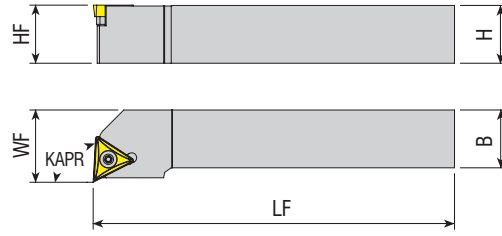

**Takım Kodu**  
**Ordering Code**  
**Bestell-Bezeichnung**

Stok  
Stock  
Lager

Takım Ölçüleri (mm)  
Dimension (mm)  
Abmessung (mm)

Kesici Uç  
Insert  
Wendeschneidplatte

Sıkma Vidası  
Screw  
Schraube

Altlık  
Shim  
Unterlage

Altlık Vidası  
Shim Screw  
Schraube für Unterlage

Tork Anahtar  
Torx Key  
Torx-Schlüssel

R L HF=H B LF WF



Takım Kodu Ordering Code Bestell-Bezeichnung	R	L	HF=H	B	LF	WF
STUCR/L 0808 E09	●	●	08	08	70	10
1010 E09	●	●	10	10	70	12
1212 F11	●	●	12	12	80	16
1616 H11	●	●	16	16	100	20
1616 H16	○	○	16	16	100	20
2020 K16	●	●	20	20	125	25
2525 M16	●	●	25	25	150	32
3232 P16	●	●	32	32	170	40

TC.T 0902..

3007-M2.2x5

-

-

80-T07

TC.T 1102..

4008-M2.5x6

-

-

80-T08

TC.T 16T3..

4015-M3.5x14

AATN-2-0001

AAV-06-M3.5x11

80-T15

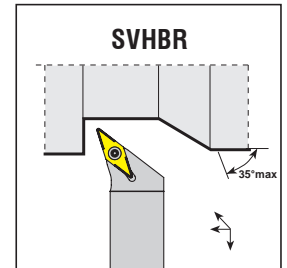
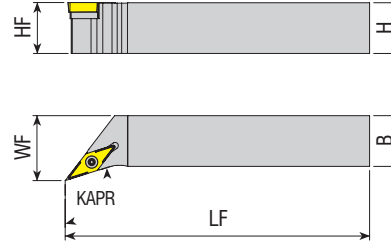
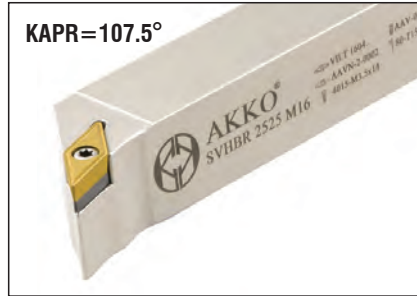

**Takım Kodu**  
**Ordering Code**  
**Bestell-Bezeichnung**

Stok  
Stock  
Lager

Takım Ölçüleri (mm)  
Dimension (mm)  
Abmessung (mm)

Kesici Uç  
Insert  
Wendeschneidplatte

Sıkma Vidası  
Screw  
Schraube

Altlık  
Shim  
Unterlage

Altlık Vidası  
Shim Screw  
Schraube für Unterlage

Tork Anahtar  
Torx Key  
Torx-Schlüssel

R L HF=H B LF WF



Takım Kodu Ordering Code Bestell-Bezeichnung	R	L	HF=H	B	LF	WF
SVHBR/L 1212 F11	●	●	12	12	80	16
1616 H11	●	●	16	16	100	20
2020 K11	●	●	20	20	125	25
2020 K16	●	●	20	20	125	25
2525 M16	●	●	25	25	150	32
3232 P16	●	●	32	32	170	40

VBM. 1103..

4008-M2.5x6

-

-

80-T08

VB.T 1604..

4015-M3.5x14

AAVN-2-0002

AAV-06-M3.5x11

80-T15

R: Sağ / Right / Rechts L: Sol/Left/Links

● Stokta / In Stock / Auf Lager ○ Stokta Yok / Non Stock Item / Kein Lagerartikel, Lieferzeit auf Anfrage

Sipariş Örneği/Ordering Example/Bestellbeispiel

1 ad./pcs./stück STUCR 0808 E09



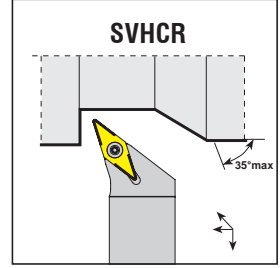
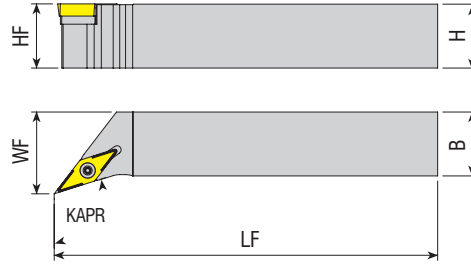
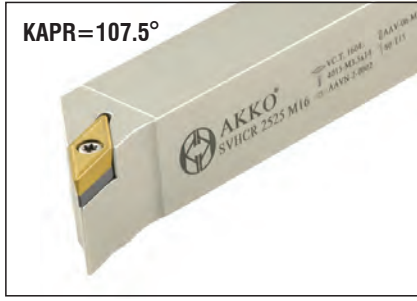

Takım Kodu Ordering Code Bestell-Bezeichnung	Stok Stock Lager		Takım Ölçüleri (mm) Dimension (mm) Abmessung (mm)				Kesici Uç Insert Wendeschneidplatte	Yedek Parçaları / Spare Parts / Ersatzteile			
	R	L	HF=H	B	LF	WF		Sıkma Vidası Screw Schraube	Altık Shim Unterlage	Altık Vidası Shim Screw Schraube für Unterlage	Tork Anahtar Torx Key Torx-Schlüssel
SVHCR/L 1212 F11	●	●	12	12	80	16	VC.T 1103..	4008-M2.5x6	-	-	80-T08
1616 H11	●	●	16	16	100	20					
2020 K11	●	●	20	20	125	25					
2020 K16	●	●	20	20	125	25	VC.T 1604..	4015-M3.5x14	AAVN-2-0002	AAV-06-M3.5x11	80-T15
2525 M16	●	●	25	25	150	32					
3232 P16	●	●	32	32	170	40					

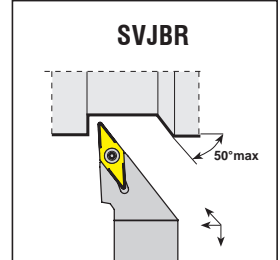
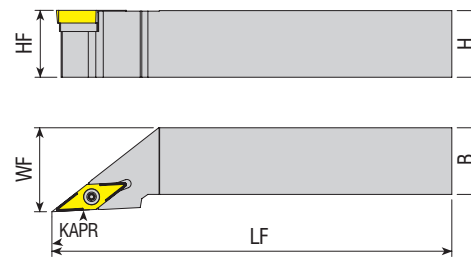

Takım Kodu Ordering Code Bestell-Bezeichnung	Stok Stock Lager		Takım Ölçüleri (mm) Dimension (mm) Abmessung (mm)				Kesici Uç Insert Wendeschneidplatte	Yedek Parçaları / Spare Parts / Ersatzteile			
	R	L	HF=H	B	LF	WF		Sıkma Vidası Screw Schraube	Altık Shim Unterlage	Altık Vidası Shim Screw Schraube für Unterlage	Tork Anahtar Torx Key Torx-Schlüssel
SVJBR/L 1212 F11	●	●	12	12	80	16	VB.T 1103..	4008-M2.5x6	-	-	80-T08
1616 H11	●	●	16	16	100	20					
2020 K11	●	●	20	20	125	25					
1616 H16	●	●	16	16	100	20	VB.T 1604..	4015-M3.5x14	AAVN-2-0002	AAV-06-M3.5x11	80-T15
2020 K16	●	●	20	20	125	25					
2525 M16	●	●	25	25	150	32					
3232 P16	●	●	32	32	170	40					

R: Sağ / Right / Rechts L: Sol/Left/Links  
● Stokta / In Stock / Auf Lager ○ Stokta Yok / Non Stock Item / Kein Lagerartikel, Lieferzeit auf Anfrage

Sipariş Örneği/Ordering Example/Bestellbeispiel  
1 ad./pcs./stück SVHCR 1212 F11

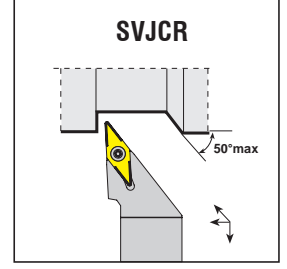
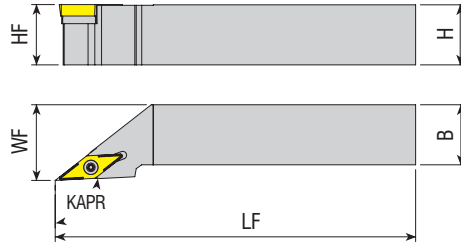

Takım Kodu Ordering Code Bestell-Bezeichnung	Stok / Stock / Lager						Kesici Uç Insert Wendeschneidplatte	Yedek Parçaları / Spare Parts / Ersatzteile				
	Stok / Stock / Lager		Takım Ölçüleri (mm) Dimension (mm) Abmessung (mm)					Sıkma Vidası Screw Schraube	Altlık Shim Unterlage	Altlık Vidası Shim Screw Schraube für Unterlage	Tork Anahtar Torx Key Torx-Schlüssel	
	R	L	HF=H	B	LF	WF						
SVJCR/L 1212 F11	●	●	12	12	80	16	VC.T 1103..	4008-M2.5x6	-	-	80-T08	
1616 H11	●	●	16	16	100	20						
2020 K11	●	●	20	20	125	25						
2525 M11	●	●	25	25	150	32	VC.T 1604..	4015-M3.5x11	AAVN-2-0002	AAV-06-M3.5x11	80-T15	
1212 F16	●	●	12	12	80	16						
2020 K16	●	●	20	20	125	25						
2525 M16	●	●	25	25	150	32						
3232 P16	●	●	32	32	170	40						

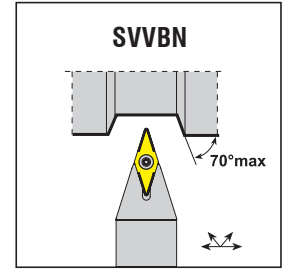
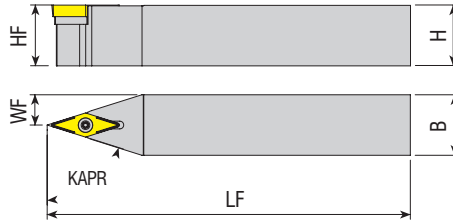

Takım Kodu Ordering Code Bestell-Bezeichnung	Stok / Stock / Lager						Kesici Uç Insert Wendeschneidplatte	Yedek Parçaları / Spare Parts / Ersatzteile				
	Stok / Stock / Lager		Takım Ölçüleri (mm) Dimension (mm) Abmessung (mm)					Sıkma Vidası Screw Schraube	Altlık Shim Unterlage	Altlık Vidası Shim Screw Schraube für Unterlage	Tork Anahtar Torx Key Torx-Schlüssel	
	R	L	HF=H	B	LF	WF						
SVVBN 1212 F11	●		12	12	80	06	VBM. 1103..	4008-M2.5x6	-	-	80-T08	
1616 H11	●		16	16	100	08						
2020 K11	●		20	20	125	10						
2020 K16	●		20	20	125	10	VB.T 1604..	4015-M3.5x14	AAVN-2-0002	AAV-06-M3.5x11	80-T15	
2525 M16	●		25	25	150	12.5						
3232 P16	●		32	32	170	16						

R: Sağ / Right / Rechts L: Sol/Left/Links

● Stokta / In Stock / Auf Lager ○ Stokta Yok / Non Stock Item / Kein Lagerartikel, Lieferzeit auf Anfrage

Sipariş Örneği/Ordering Example/Bestellbeispiel

1 ad./pcs./stück SVJCR 1212 F11

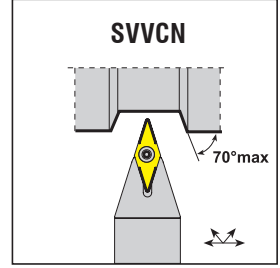
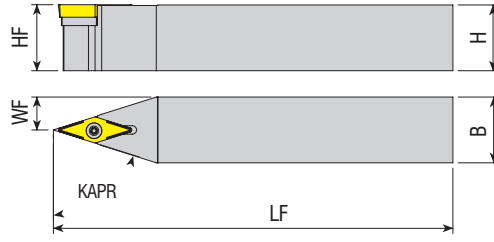

**Takım Kodu**  
**Ordering Code**  
**Bestell-Bezeichnung**

Stok  
Stock  
Lager

Takım Ölçüleri (mm)  
Dimension (mm)  
Abmessung (mm)

Kesici Uç  
Insert  
Wendeschneidplatte

Sıkma Vidası  
Screw  
Schraube

Altlık  
Shim  
Unterlage

Altlık Vidası  
Shim Screw  
Schraube für Unterlage

Tork Anahtar  
Torx Key  
Torx-Schlüssel

Yedek Parçaları / Spare Parts / Ersatzteile

HF=H	B	LF	WF
------	---	----	----

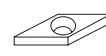

SVVCN 1212 F11	●	12	12	80	06
1616 H11	●	16	16	100	08
2020 K11	●	20	20	125	10
2020 K16	●	20	20	125	10
2525 M16	●	25	25	150	12.5
3232 P16	●	32	32	170	16

VC.T 1103..

4008-M2.5x6

-

-

80-T08

VC.T 1604..

4015-M3.5x14

AAVN-2-0002

AAV-06-M3.5x11

80-T15

S-SİSTEM İSVİÇRE TİPİ KAYAR OTOMAT MAKİNA TAKIMLARI  
S-SYSTEM TOOLS FOR SWISS TYPE SLIDING AUTOMATIC LATHES  
S-SYSTEM FÜR LANGDREHAUTOMATEN

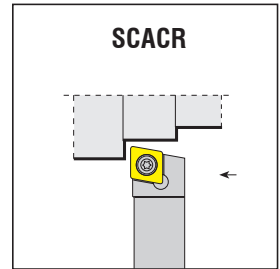
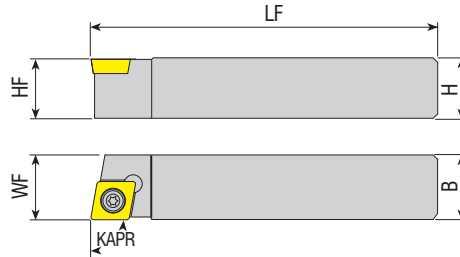
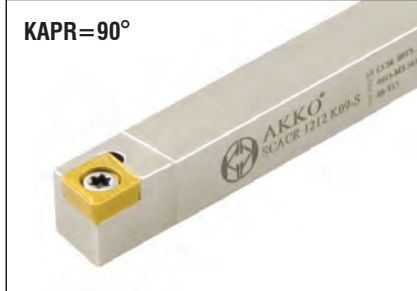

**Takım Kodu**  
**Ordering Code**  
**Bestell-Bezeichnung**

Stok  
Stock  
Lager

Takım Ölçüleri (mm)  
Dimension (mm)  
Abmessung (mm)

Kesici Uç  
Insert  
Wendeschneidplatte

Sıkma Vidası  
Screw  
Schraube

Altlık  
Shim  
Unterlage

Altlık Vidası  
Shim Screw  
Schraube für Unterlage

Tork Anahtar  
Torx Key  
Torx-Schlüssel

Yedek Parçaları / Spare Parts / Ersatzteile

R	L	HF=H	B	LF	WF
---	---	------	---	----	----



SCACR/L 0808 X06-S	●	●	08	08	115	08
1010 K06-S	●	○	10	10	125	10
1212 G06-S	●	○	12	12	90	12
1212 K06-S	●	○	12	12	125	12
1616 F06-S	○	○	16	16	75	16
1616 K06-S	○	○	16	16	125	16
1212 G09-S	○	○	12	12	90	12
1212 K09-S	●	●	12	12	125	12
1616 F09-S	○	○	16	16	75	16
1616 K09-S	●	●	16	16	125	16
2020 K09-S	●	●	20	20	125	20

CC.T 0602..

4008-M2.5x6

-

-

80-T08

CC.T 09T3..

4015-M3.5x11

-

-

80-T15

R: Sağ / Right / Rechts L: Sol/Left/Links

● Stokta / In Stock / Auf Lager ○ Stokta Yok / Non Stock Item / Kein Lagerartikel, Lieferzeit auf Anfrage

Sipariş Örneği/Ordering Example/Bestellbeispiel

1 ad./pcs./stück SVVCN 1212 F11

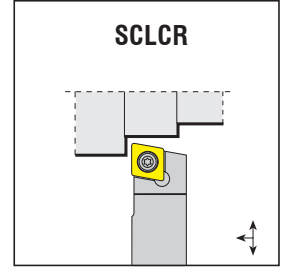
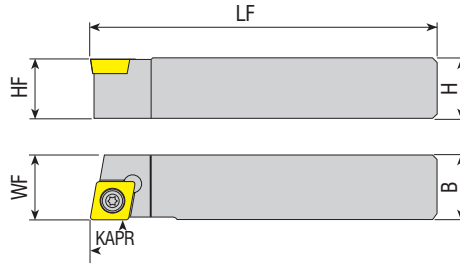
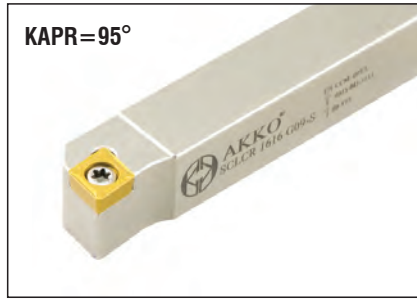

Takım Kodu Ordering Code Bestell-Bezeichnung	Stok Stock Lager						Takım Ölçüleri (mm) Dimension (mm) Abmessung (mm)	Kesici Uç Insert Wendeschneidplatte	Yedek Parçaları / Spare Parts / Ersatzteile			
	R		HF=H	B	LF	WF			Sıkma Vidası Screw Schraube	Altlık Shim Unterlage	Altlık Vidası Shim Screw Schraube für Unterlage	Tork Anahtar Torx Key Torx-Schlüssel
	R	L										
<b>SCLCR/L 0808 X06-S</b>	●	●	08	08	115	08	<b>CC.T 0602..</b>					
<b>1010 X06-S</b>	●	○	10	10	115	10						
<b>1212 G06-S</b>	●	●	12	12	90	12						
<b>1212 X06-S</b>	●	○	12	12	130	12						
<b>1212 K06-S</b>	○	●	12	12	125	12						
<b>1616 F06-S</b>	●	○	16	16	75	16						
<b>1616 X06-S</b>	●	○	16	16	130	16						
<b>1212 G09-S</b>	●	●	12	12	90	12						
<b>1212 X09-S</b>	●	○	12	12	130	12						
<b>1616 F09-S</b>	●	○	16	16	75	16						
<b>1616 G09-S</b>	●	○	16	16	90	16	<b>CC.T 09T3..</b>					
<b>1616 X09-S</b>	●	○	16	16	115	16						
<b>2020 X09-S</b>	●	○	20	20	120	20						

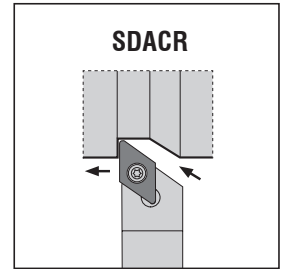
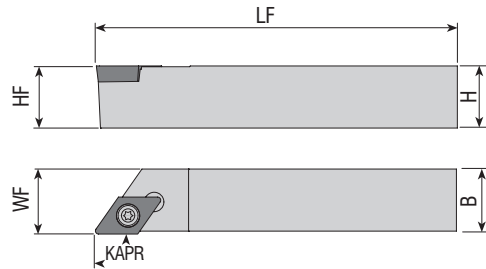

Takım Kodu Ordering Code Bestell-Bezeichnung	Stok Stock Lager						Takım Ölçüleri (mm) Dimension (mm) Abmessung (mm)	Kesici Uç Insert Wendeschneidplatte	Yedek Parçaları / Spare Parts / Ersatzteile							
	R		HF=H	B	LF	WF			Sıkma Vidası Screw Schraube	Altlık Shim Unterlage	Altlık Vidası Shim Screw Schraube für Unterlage	Tork Anahtar Torx Key Torx-Schlüssel				
	R	L														
<b>SDACR/L 0808 X07-S</b>	●	●	08	08	115	08	<b>DC.T 0702..</b>									
<b>1010 K07-S</b>	●	●	10	10	125	10										
<b>1212 G07-S</b>	○	○	12	12	90	12										
<b>1212 K07-S</b>	●	●	12	12	125	12										
<b>1616 F07-S</b>	●	○	16	16	75	16										
<b>1616 K07-S</b>	●	●	16	16	125	16										
<b>1212 G11-S</b>	○	○	12	12	90	12						<b>DC.T 11T3..</b>				
<b>1212 K11-S</b>	●	●	12	12	125	12										
<b>1616 F11-S</b>	●	○	16	16	75	16										
<b>1616 K11-S</b>	●	●	16	16	125	16										
<b>2020 K11-S</b>	●	●	20	20	125	20										

R: Sağ / Right / Rechts L: Sol/Left/Links

● Stokta / In Stock / Auf Lager ○ Stokta Yok / Non Stock Item / Kein Lagerartikel, Lieferzeit auf Anfrage

Sipariş Örneği/Ordering Example/Bestellbeispiel

1 ad./pcs./stück SCLCR 0808 X06-S



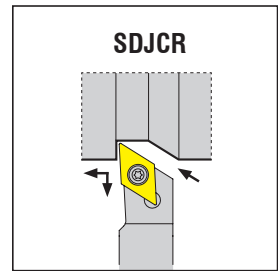
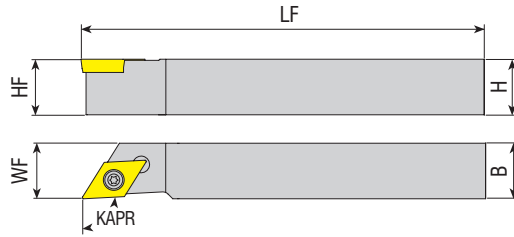
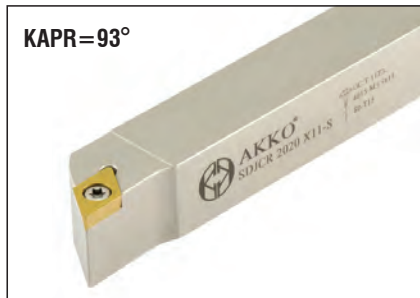

Takım Kodu Ordering Code Bestell-Bezeichnung	Stok Stock Lager		Takım Ölçüleri (mm) Dimension (mm) Abmessung (mm)				Kesici Uç Insert Wendeschneidplatte	Yedek Parçaları / Spare Parts / Ersatzteile			
	R	L	HF=H	B	LF	WF		Sıkma Vidası Screw Schraube	Altlık Shim Unterlage	Altlık Vidası Shim Screw Schraube für Unterlage	Tork Anahtar Torx Key Torx-Schlüssel
<b>SDJCR/L 0808 X07-S</b>	●	○	08	08	115	08	<b>DC.T 0702..</b>	4008-M2.5x6	-	-	80-T08
<b>1010 X07-S</b>	●	●	10	10	115	10					
<b>1212 G07-S</b>	●	○	12	12	90	12					
<b>1212 X07-S</b>	●	●	12	12	130	12					
<b>1616 F07-S</b>	●	○	16	16	75	16					
<b>1616 X07-S</b>	●	○	16	16	130	16					
<b>2020 X07-S</b>	●	○	20	20	120	20					
<b>1212 G11-S</b>	●	○	12	12	90	12	<b>DC.T 11T3..</b>	4015-M3.5x11	-	-	80-T15
<b>1212 X11-S</b>	●	●	12	12	130	12					
<b>1212 K11-S</b>	●	●	12	12	125	12					
<b>1616 F11-S</b>	●	○	16	16	75	16					
<b>1616 X11-S</b>	●	●	16	16	130	16					
<b>1616 K11-S</b>	●	●	16	16	125	16					
<b>2020 X11-S</b>	●	○	20	20	120	20					

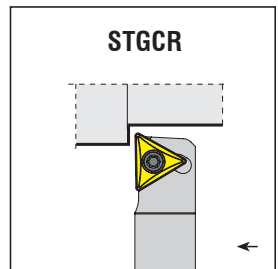
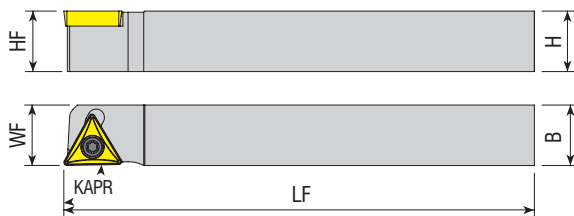

Takım Kodu Ordering Code Bestell-Bezeichnung	Stok Stock Lager		Takım Ölçüleri (mm) Dimension (mm) Abmessung (mm)				Kesici Uç Insert Wendeschneidplatte	Yedek Parçaları / Spare Parts / Ersatzteile			
	R	L	HF=H	B	LF	WF		Sıkma Vidası Screw Schraube	Altlık Shim Unterlage	Altlık Vidası Shim Screw Schraube für Unterlage	Tork Anahtar Torx Key Torx-Schlüssel
<b>STGCR/L 1216 K11-S</b>	●	○	12	16	125	16	<b>TC.T 1102..</b>	4008-M2.5x6	-	-	80-T08
<b>1616 K11-S</b>	●	○	16	16	125	16					
<b>1216 K16-S</b>	●	○	12	16	125	16	<b>TC.T 16T3..</b>	4015-M3.5x11	-	-	80-T15
<b>1616 K16-S</b>	●	○	16	16	125	16					

R: Sağ / Right / Rechts L: Sol/Left/Links

● Stokta / In Stock / Auf Lager ○ Stokta Yok / Non Stock Item / Kein Lagerartikel, Lieferzeit auf Anfrage

Sipariş Örneği/Ordering Example/Bestellbeispiel

1 ad./pcs./stück SDJCR 0808 X07-S

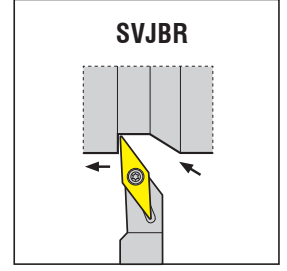
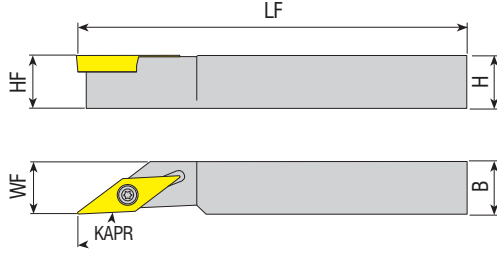

Takım Kodu Ordering Code Bestell-Bezeichnung	Stok Stock Lager		Takım Ölçüleri (mm) Dimension (mm) Abmessung (mm)				Kesici Uç Insert Wendeschneidplatte	Yedek Parçaları / Spare Parts / Ersatzteile				
	R	L	HF=H	B	LF	WF		Sıkma Vidası Screw Schraube	Altlık Shim Unterlage	Altlık Vidası Shim Screw Schraube für Unterlage	Tork Anahtar Torx Key Torx-Schlüssel	
SVJBR/L 1616 K11-S	●	●	16	16	125	16			-	-		

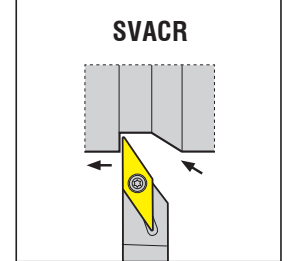
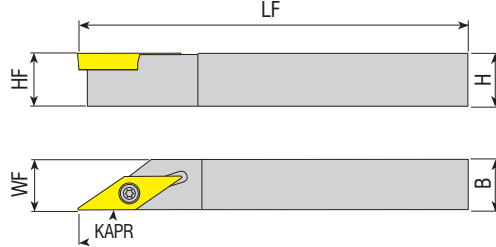

Takım Kodu Ordering Code Bestell-Bezeichnung	Stok Stock Lager		Takım Ölçüleri (mm) Dimension (mm) Abmessung (mm)				Kesici Uç Insert Wendeschneidplatte	Yedek Parçaları / Spare Parts / Ersatzteile				
	R	L	HF=H	B	LF	WF		Sıkma Vidası Screw Schraube	Altlık Shim Unterlage	Altlık Vidası Shim Screw Schraube für Unterlage	Tork Anahtar Torx Key Torx-Schlüssel	
SVACR/L 0808 X11-S	○	○	08	08	115	08			-	-		
1010 K11-S	●	○	10	10	125	10						
1212 G11-S	○	○	12	12	90	12						
1212 K11-S	●	●	12	12	125	12						
1616 F11-S	○	○	16	16	75	16						
1616 K11-S	●	●	16	16	125	16						
2020 K11-S	●	●	20	20	125	20						
1212 K16-S	●	●	12	12	125	12			-	-		
1616 K16-S	●	●	16	16	125	16						

R: Sağ / Right / Rechts L: Sol/Left/Links  
● Stokta / In Stock / Auf Lager ○ Stokta Yok / Non Stock Item / Kein Lagerartikel, Lieferzeit auf Anfrage

Sipariş Örneği/Ordering Example/Bestellbeispiel  
1 ad./pcs./stück SVJBR 1616 K11-S

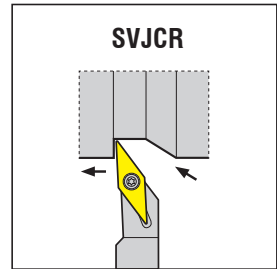
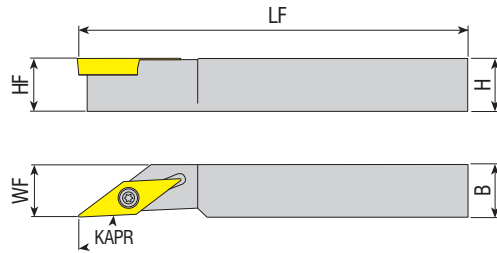

Takım Kodu Ordering Code Bestell-Bezeichnung	Stok Stock Lager		Takım Ölçüleri (mm) Dimension (mm) Abmessung (mm)				Kesici Uç Insert Wendeschneidplatte	Yedek Parçaları / Spare Parts / Ersatzteile			
	R	L	HF=H	B	LF	WF		Sıkma Vidası Screw Schraube	Altık Shim Unterlage	Altık Vidası Shim Screw Schraube für Unterlage	Tork Anahtar Torx Key Torx-Schlüssel
SVJCR/L 0808 X11-S	●	○	08	08	115	08	VC.T 1103..	4008-M2.5x6	-	-	80-T08
1010 K11-S	●	○	10	10	125	10					
1212 G11-S	○	○	12	12	90	12					
1212 K11-S	●	●	12	12	125	12					
1616 F11-S	○	○	16	16	75	16					
1616 K11-S	●	○	16	16	125	16					
2020 K11-S	○	○	20	20	125	20					

SEC TOOLS

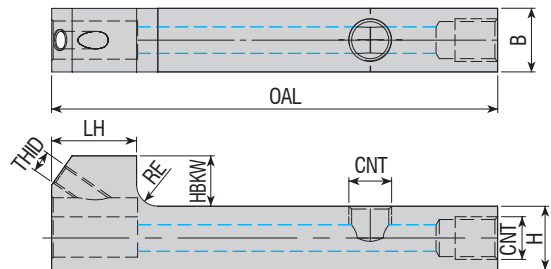

Takım Kodu Ordering Code Bestell-Bezeichnung	Stok Stock Lager		Takım Ölçüleri (mm) Dimension (mm) Abmessung (mm)							Yedek Parçaları / Spare Parts / Ersatzteile			
	R	L	H	B	RE	HBKW	LH	OAL	CNT	THID	Sızdırmaz Vida Threaded Pin Gewindestift	Montaj Vidası Mounting Screw Befestigungsschraube	Anahtar Allen Key Innensechskantschlüssel
ASTB-1212-L84-H	●	○	12	12	4	9.5	16	84	M8X1X5	M4x0.7	2704-M8X1X5	2503-M4x12-C	AAL-03-3
ASTB-1616-L90-H	●	○	16	16	1	5.5	16	90	M8X1X5	M4x0.7			

R: Sağ / Right / Rechts L: Sol/Left/Links  
● Stokta / In Stock / Auf Lager ○ Stokta Yok / Non Stock Item / Kein Lagerartikel, Lieferzeit auf Anfrage

Sipariş Örneği/Ordering Example/Bestellbeispiel  
1 ad./pcs./stück SVJCR 0808 X11-S



KAPR=93°

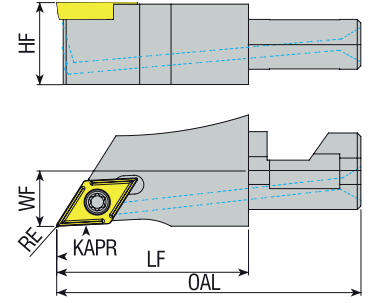

Takım Kodu Ordering Code Bestell-Bezeichnung	Stok Stock Lager		Takım Ölçüleri (mm) Dimension (mm) Abmessung (mm)				Kesici Uç Insert Wendeschneidplatte	Yedek Parçaları / Spare Parts / Ersatzteile		
	R	L	HF	WF	RE	LF		OAL	Sıkma Vidası Screw Schraube	Tork Anahtar Torx Key Torx-Schlüssel
SDJCR/L-12X43.3-07	●	●	11.8	8	0.2	27.3	43.3	DC.T 070202	4008-M2.5x6	80-T08
12X43.3-07-H	●	●	11.8	8	0.2	27.3	43.3			
16X43.3-07	●	●	15.8	8	0.2	27.3	43.3			
16X43.3-07-H	●	●	15.8	8	0.2	27.3	43.3			
12X43.3-11	●	●	11.8	8	0.2	27.3	43.3	DC.T 11T302	4015-M3.5x11	80-T15
12X43.3-11-H	●	●	11.8	8	0.2	27.3	43.3			
16X43.3-11	●	●	15.8	8	0.2	27.3	43.3			
16X43.3-11-H	●	●	15.8	8	0.2	27.3	43.3			



KAPR=93°

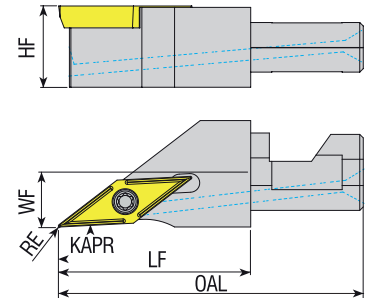

Takım Kodu Ordering Code Bestell-Bezeichnung	Stok Stock Lager		Takım Ölçüleri (mm) Dimension (mm) Abmessung (mm)				Kesici Uç Insert Wendeschneidplatte	Yedek Parçaları / Spare Parts / Ersatzteile		
	R	L	HF	WF	RE	LF		OAL	Sıkma Vidası Screw Schraube	Tork Anahtar Torx Key Torx-Schlüssel
SVJCR/L-12X43.3-11	●	●	11.8	8	0.2	27.3	43.3	VC.T 110302	4008-M2.5x6	80-T08
12X43.3-11-H	●	●	11.8	8	0.2	27.3	43.3			
16X43.3-11	●	●	15.8	8	0.2	27.3	43.3			
16X43.3-11-H	●	●	15.8	8	0.2	27.3	43.3			

R: Sağ / Right / Rechts L: Sol/Left/Links

● Stokta / In Stock / Auf Lager ○ Stokta Yok / Non Stock Item / Kein Lagerartikel, Lieferzeit auf Anfrage

Sipariş Örneği/Ordering Example/Bestellbeispiel

1 ad./pcs./stück SDJCR-12X43.3-07



new

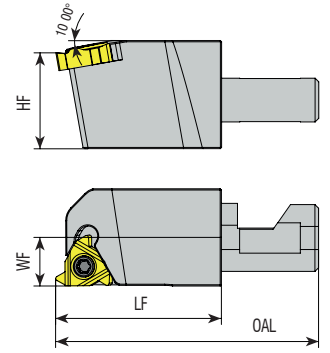

**Takım Kodu**  
**Ordering Code**  
**Bestell-Bezeichnung**

Stok Stock Lager		Takım Ölçüleri (mm) Dimension (mm) Abmessung (mm)					Kesici Uç Insert Wendeschneidplatte	Yedek Parçaları / Spare Parts / Ersatzteile					
		R	L	OAL	LF	WF		HF	Sıkma Vidası Screw Schraube	Sağ Altlık Right Shim U-Platte für WSP rechts	Sol Altlık Left Shim U-Platte für WSP links	Altlık Vidası Shim Screw Schraube für Unterlage	Altlık Vidası Pulu Shim Screw Ring Schraube für Unterlagering
							<b>11 ER/EL</b>	4008-M2.5x6	-	-	-	-	80-T08
							<b>16 ER/EL</b>	1710-U5-40x12.2	ATS-16E	ATS-16I	AAV-11-U5-40x4.5	ABPL-03	80-T10

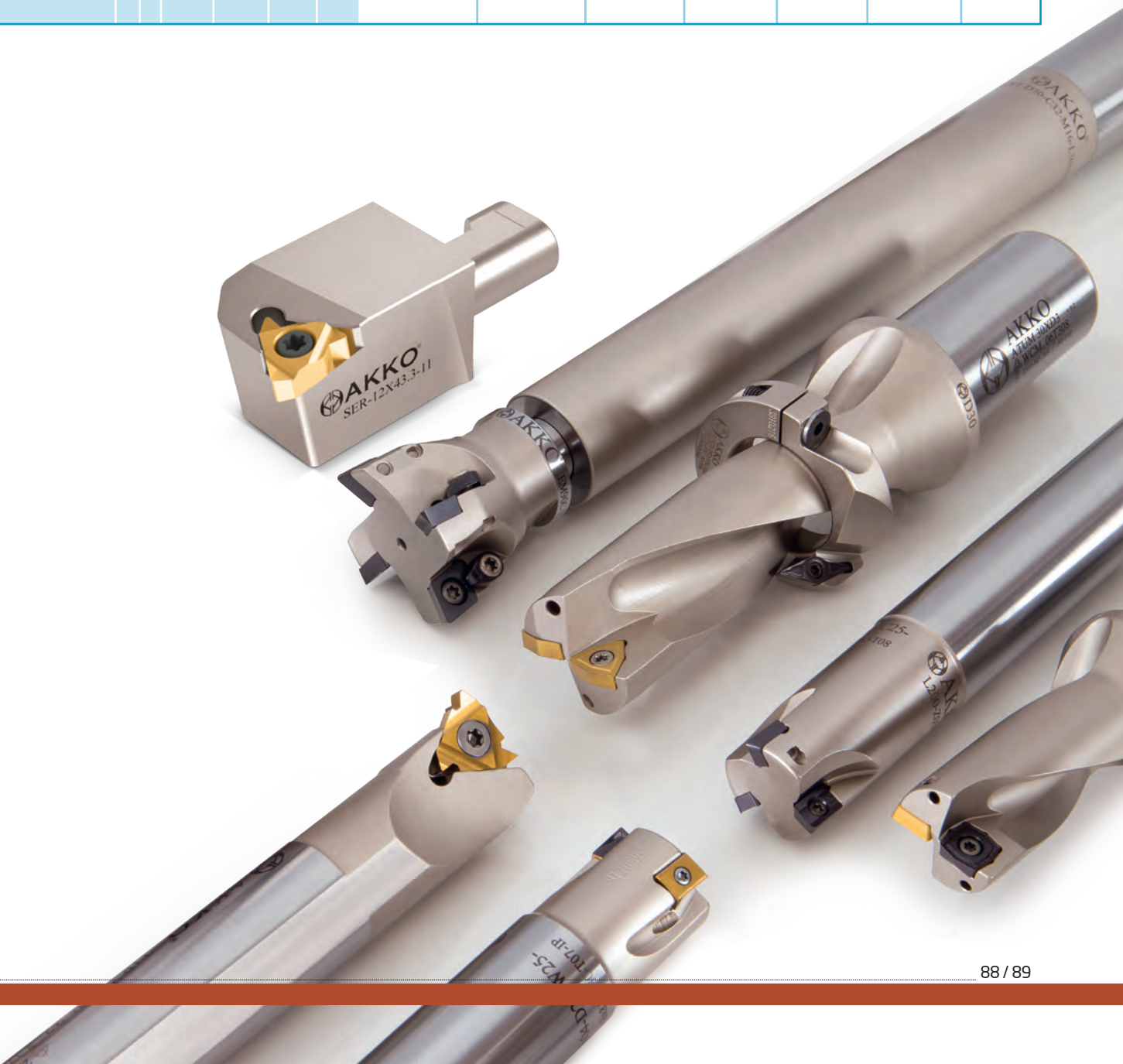

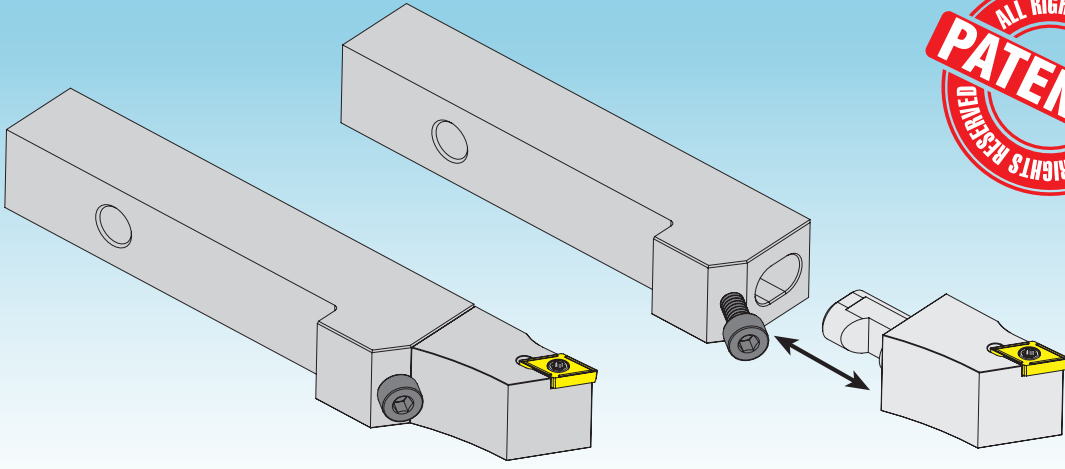

Takım tutucuyu, bağlama ünitesinden sökme zorunluğundan hızlıca değiştirin!

Quick change, without having to remove the tool-holder from the gang !

Es ist nicht nötig, den Grundhalter vom Werkzeugträger zu entfernen schnelle wechsellösung möglich!

Makina dışında ön ayar yapmak mümkün.

Presetting is possible outside of the machine.

Voreinstellung ausserhalb der Maschine ist möglich.

Çok hassas montaj.

Ultra precise fitting.

Ultra-präziser Montage.

Rijit sabitleme.

Rigid fixation.

Starre Befestigung.

Takım tutucu bölümü: 12x12 ve 16x16 mm.

Tool-holder section : 12x12 and 16x16 mm.

Grundhalter: 12x12 und 16x16mm.

Sağ ve sol uçlar kullanılır.

Left and right inserts available.

Links und Rechts WSP verwendbar.

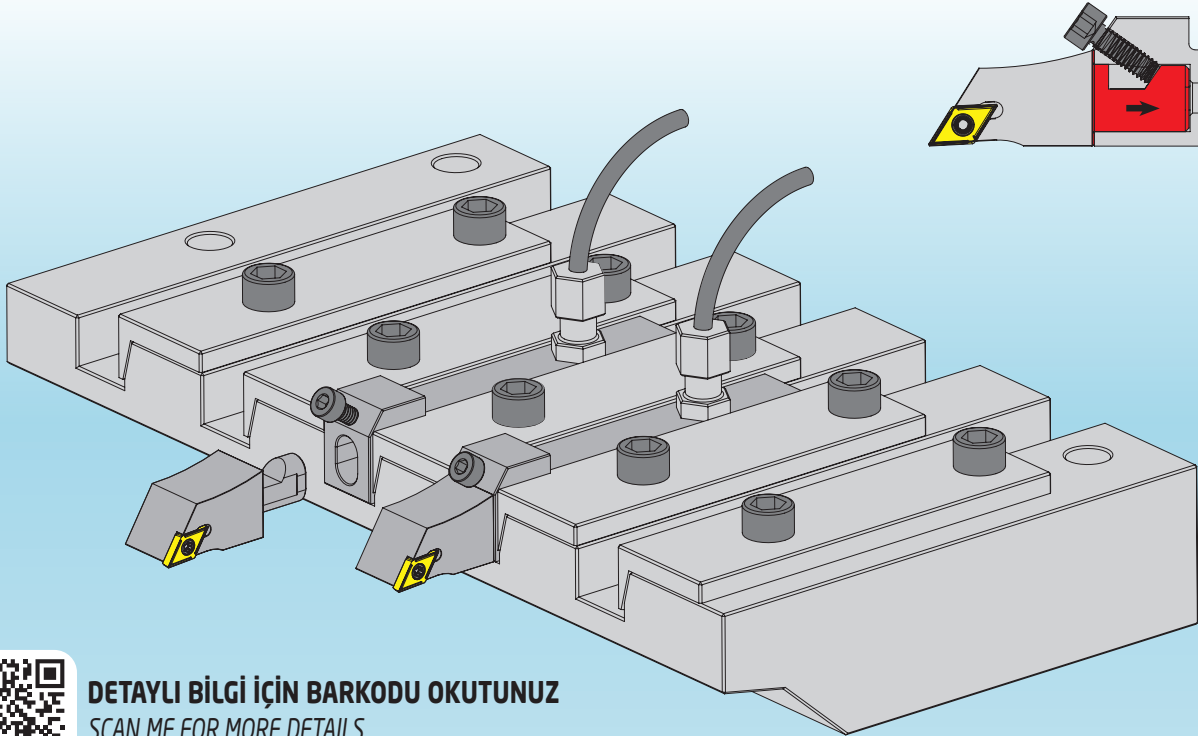

**DETAYLI BİLGİ İÇİN BARKODU OKUTUNUZ**

SCAN ME FOR MORE DETAILS

SCANNEN SIE MICH NACH WEITEREN DETAILS

**DELİK TORNA TAKIMLARI**  
**INTERNAL TURNING TOOLHOLDERS**  
**DREHWERKZEUGE FÜR DIE INNENBEARBEITUNG**



**S 25 S P C L N R 12 C**

**1** Takım Malzemesi / Type of Boring Bar / Art der Bohrstange

"A" Yekpare çelik gövde soğutma suyu kanallı / "A" Solid steel with coolant hole  
 "A" Vollstahlausführung mit innere Kühlmittelzufuhr  
 "E" Çelik başlıkla sert metal gövde ve soğutma suyu kanallı / "E" Carbide bar with fixed steel head and coolant hole  
 "E" Hartmetallschaft mit Kopf aus Stahl und innere Kühlmittelzufuhr  
 "C" Karbür Şaft / "C" Carbide shank / "C" Hartmetallschaft mit Kopf aus Stahl ohne innere Kühlmittelzufuhr  
 "S" Çelik Şaft / "S" Steel shank / "S" Vollstahlausführung ohne innere Kühlmittelzufuhr

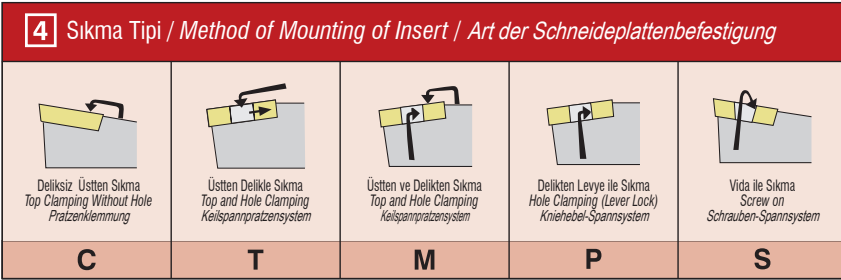
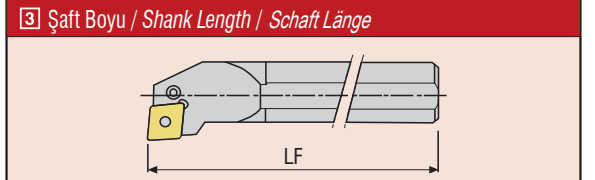
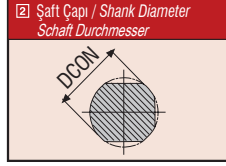

A - 32	H - 100	Q - 180	x-special
B - 40	J - 110	R - 200	
C - 50	K - 125	S - 250	
D - 60	L - 140	T - 300	
E - 70	M - 150	U - 350	
F - 80	N - 160	V - 400	
G - 90	P - 170	W - 450	

(mm)

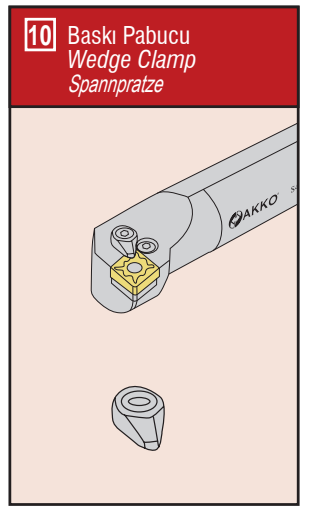
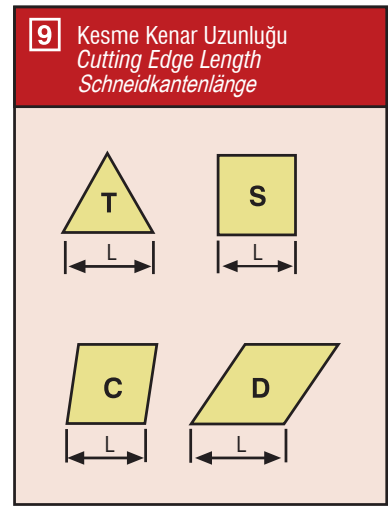
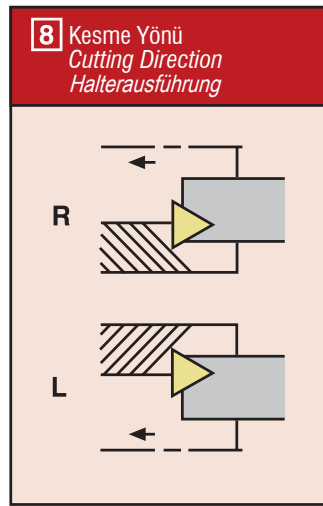
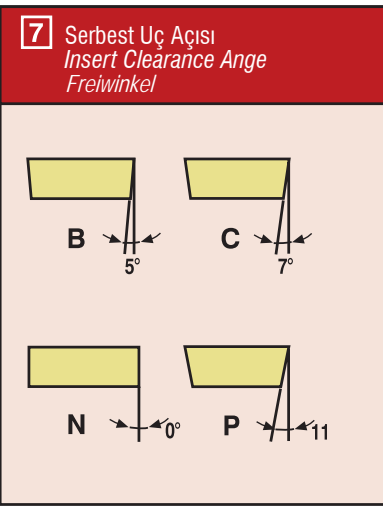
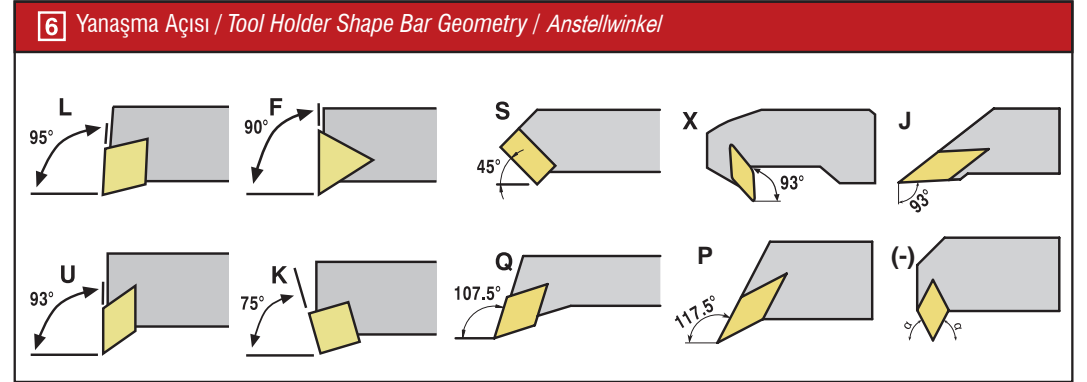
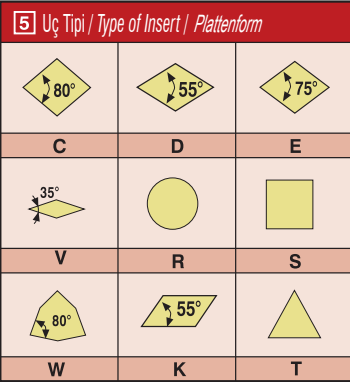





# T&C-SİSTEM

T&C SİSTEM DELİK TORNA KATERLERİ  
T&C SYSTEM BORING BARS  
T&C SYSTEM BOHRSTANGE

*konusulan  
the spoken kalite...  
quality...*



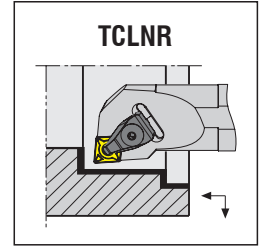
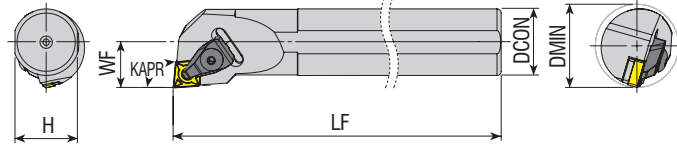

Takım Kodu Ordering Code Bestell-Bezeichnung	Stok Stock Lager		Takım Ölçüleri (mm) Dimension (mm) Abmessung (mm)					Kesici Uç Insert Wendeschneidplatte	Yedek Parçaları / Spare Parts / Ersatzteile						
	R	L	DCON	H	LF	WF	DMIN		Baskı Pabucu Wedge Clamp Spannpratze	Pabuç Vidası Clamp Screw Klemmschraube	Altlık Shim Unterlage	Altlık Vidası Shim Screw Schraube für Unterlage	Sekman Ring Feder	Pul Stamp Ring	Anahtar Allen Key Innerschraubenschlüssel
S25S TCLNR/L 09	●	●	25	23	250	17	≥32	CNM. 0903..	ATK-01	AKV-01-M5x22	AACN-2-0001	AAV-09-M5x9	-	ABPL-01	AAL-03-3
S25S TCLNR/L 12	●	●	25	23	250	17	≥32					AAV-13-M5x8			
S32T TCLNR/L 12	●	●	32	30	300	22	≥40	CNM. 1204..	ATK-02	AKV-30-M6x22	AACN-3-0001	AAV-02-M5x12	AS-01	ABPL-01	AAL-03-3
S40U TCLNR/L 12	●	●	40	37.5	350	27	≥50								
S50V TCLNR/L 12	●	●	50	47	400	35	≥63								
S32T TCLNR/L 16	●	●	32	30	300	22	≥40	CNM. 1606..	ATK-04	AKV-19-M7x25	AACN-3-0002	AAV-05-M6x15	AS-02	ABPL-02	AAL-05-4
S40U TCLNR/L 16	●	●	40	37.5	350	27	≥50								
S50V TCLNR/L 16	●	●	50	47	400	35	≥63								

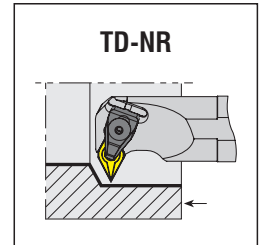
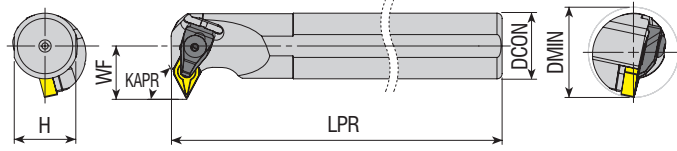
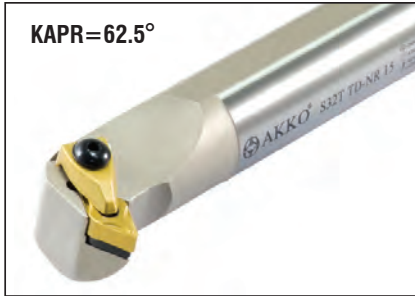

Takım Kodu Ordering Code Bestell-Bezeichnung	Stok Stock Lager		Takım Ölçüleri (mm) Dimension (mm) Abmessung (mm)					Kesici Uç Insert Wendeschneidplatte	Yedek Parçaları / Spare Parts / Ersatzteile						
	R	L	DCON	H	LPR	WF	DMIN		Baskı Pabucu Wedge Clamp Spannpratze	Pabuç Vidası Clamp Screw Klemmschraube	Altlık Shim Unterlage	Altlık Vidası Shim Screw Schraube für Unterlage	Sekman Ring Feder	Pul Stamp Ring	Anahtar Allen Key Innerschraubenschlüssel
S32T TD-NR/L 15	●	●	32	30	300	26	≥44	DNM. 1506..	ATK-02	AKV-30-M6x22	AADN-3-0001	AAV-02-M5x12	AS-01	ABPL-01	AAL-03-3
S40U TD-NR/L 15	●	●	40	37.5	350	29	≥52								
S50V TD-NR/L 15	●	●	50	47	400	35	≥63								

R: Sağ / Right / Rechts L: Sol/Left/Links

● Stokta / In Stock / Auf Lager ○ Stokta Yok / Non Stock Item / Kein Lagerartikel, Lieferzeit auf Anfrage

Sipariş Örneği/Ordering Example/Bestellbeispiel

1 ad./pcs./stück S25S TCLNR 09

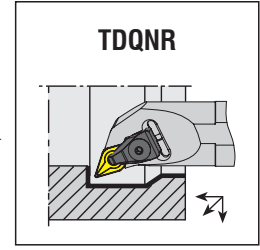
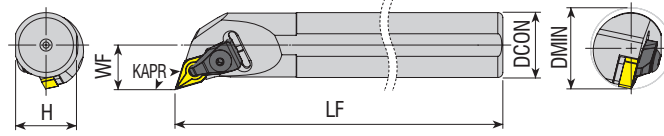

Takım Kodu Ordering Code Bestell-Bezeichnung	Stok Stock Lager		Takım Ölçüleri (mm) Dimension (mm) Abmessung (mm)					Kesici Uç Insert Wendeschneidplatte	Baskı Pabuçu Wedge Clamp Spannpratze	Pabuç Vidası Clamp Screw Klemmschraube	Altlık Shim Unterlage	Altlık Vidası Shim Screw Schraube für Unterlage	Sekman Ring Feder	Pul Stamp Ring	Anahtar Allen Key Innerschraubenschlüssel
	R	L	DCON	H	LF	WF	DMIN								
	Yedek Parçaları / Spare Parts / Ersatzteile														
S25S TDQNR/L 11	●	●	25	23	250	17	≥32	DNM. 1104..	ATK-01	AKV-01-M5x22	AADN-2-0001	AAV-09-M5x9	-	ABPL-01	AAL-03-3
S32T TDQNR/L 11	●	●	32	30	300	22	≥40					AAV-04-M5x12			
S25S TDQNR/L 15	●	●	25	23	250	17	≥32	DNM. 1506..	ATK-02	AKV-30-M6x22	AADN-3-0001	AAV-13-M5x8	AS-01	ABPL-01	AAL-03-3
S32T TDQNR/L 15	●	●	32	30	300	22	≥40					AAV-02-M5x12			
S40U TDQNR/L 15	●	●	40	37.5	350	27	≥50								
S50V TDQNR/L 15	●	●	50	47	400	35	≥63								

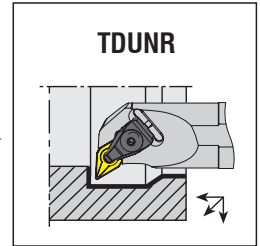
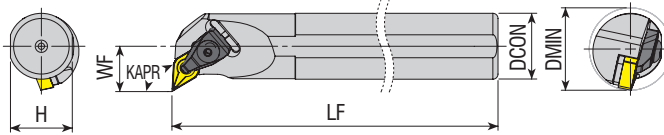

Takım Kodu Ordering Code Bestell-Bezeichnung	Stok Stock Lager		Takım Ölçüleri (mm) Dimension (mm) Abmessung (mm)					Kesici Uç Insert Wendeschneidplatte	Baskı Pabuçu Wedge Clamp Spannpratze	Pabuç Vidası Clamp Screw Klemmschraube	Altlık Shim Unterlage	Altlık Vidası Shim Screw Schraube für Unterlage	Sekman Ring Feder	Pul Stamp Ring	Anahtar Allen Key Innerschraubenschlüssel
	R	L	DCON	H	LF	WF	DMIN								
	Yedek Parçaları / Spare Parts / Ersatzteile														
S25S TDUNR/L 11	●	●	25	23	250	17	≥32	DNM. 1104..	ATK-01	AKV-01-M5x22	AADN-2-0001	AAV-09-M5x9	-	ABPL-01	AAL-03-3
S32T TDUNR/L 11	●	●	32	30	300	22	≥40					AAV-04-M5x12			
S25S TDUNR/L 15	●	●	25	23	250	17	≥34	DNM. 1506..	ATK-02	AKV-30-M6x22	AADN-3-0001	AAV-13-M5x8	AS-01	ABPL-01	AAL-03-3
S32T TDUNR/L 15	●	●	32	30	300	22	≥40					AAV-02-M5x12			
S40U TDUNR/L 15	●	●	40	37.5	350	27	≥50								
S50V TDUNR/L 15	●	●	50	47	400	35	≥63								

R: Sağ / Right / Rechts L: Sol/Left/Links

● Stokta / In Stock / Auf Lager ○ Stokta Yok / Non Stock Item / Kein Lagerartikel, Lieferzeit auf Anfrage

Sipariş Örneği/Ordering Example/Bestellbeispiel

1 ad./pcs./stück S25S TDQNR 11



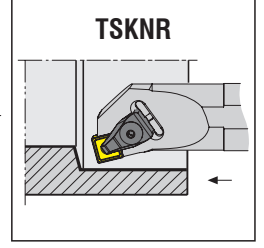
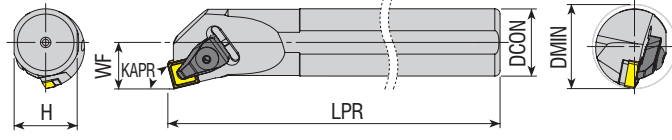

Takım Kodu Ordering Code Bestell-Bezeichnung	Stok Stock Lager		Takım Ölçüleri (mm) Dimension (mm) Abmessung (mm)					Kesici Uç Insert Wendeschneidplatte	Yedek Parçaları / Spare Parts / Ersatzteile										
	R	L	DCON	H	LPR	WF	DMIN		Baskı Pabucu Wedge Clamp Spannpratze	Pabuç Vidası Clamp Screw Klemmschraube	Altlık Shim Unterlage	Altlık Vidası Shim Screw Schraube für Unterlage	Sekman Ring Feder	Pul Stamp Ring	Anahtar Allen Key Inmenschenschlüssel				
S25S TSKNR/L 12	●	●	25	23	250	17	≥32	SNM. 1204..											
S32T TSKNR/L 12	●	●	32	30	300	22	≥40									AAV-13-M5x8	AS-01	ABPL-01	AAL-03-3
S40U TSKNR/L 12	●	●	40	37.5	350	27	≥50									AASN-3-0004	AAV-02-M5x12		

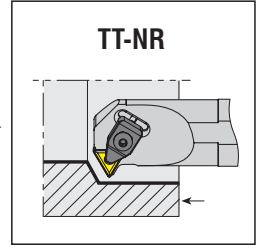
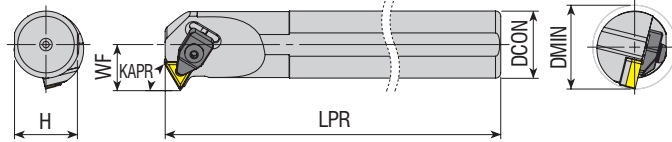
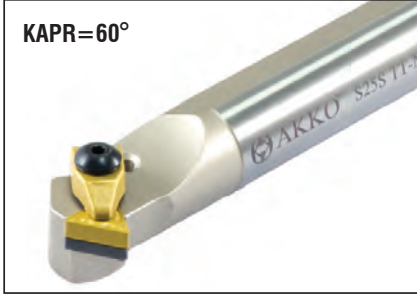

Takım Kodu Ordering Code Bestell-Bezeichnung	Stok Stock Lager		Takım Ölçüleri (mm) Dimension (mm) Abmessung (mm)					Kesici Uç Insert Wendeschneidplatte	Yedek Parçaları / Spare Parts / Ersatzteile						
	R	L	DCON	H	LPR	WF	DMIN		Baskı Pabucu Wedge Clamp Spannpratze	Pabuç Vidası Clamp Screw Klemmschraube	Altlık Shim Unterlage	Altlık Vidası Shim Screw Schraube für Unterlage	Yay Spring Feder	Pul Stamp Ring	Anahtar Allen Key Inmenschenschlüssel
S25S TT-NR/L 16	●	●	25	23	250	17	≥32	TNM. 1604..							
S32T TT-NR/L 16	●	●	32	30	300	22	≥40								

R: Sağ / Right / Rechts L: Sol/Left/Links  
● Stokta / In Stock / Auf Lager ○ Stokta Yok / Non Stock Item / Kein Lagerartikel, Lieferzeit auf Anfrage

Sipariş Örneği/Ordering Example/Bestellbeispiel  
1 ad./pcs./stück S25S TSKNR 12



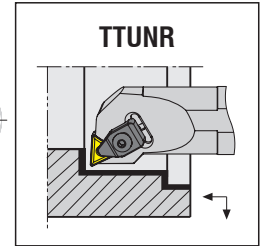
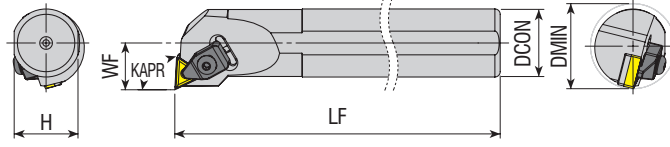

Takım Kodu Ordering Code Bestell-Bezeichnung	Stok Stock Lager		Takım Ölçüleri (mm) Dimension (mm) Abmessung (mm)					Kesici Uç Insert Wendeschneidplatte	Baskı Pabuçu Wedge Clamp Spannpratze	Pabuç Vidası Clamp Screw Klemmschraube	Altlık Shim Unterlage	Altlık Vidası Shim Screw Schraube für Unterlage	Sekman Ring Feder	Pul Stamp Ring	Anahtar Allen Key Innerschraubenschlüssel
	R	L	DCON	H	LF	WF	DMIN								
S25S TTUNR/L 16	●	●	25	23	250	17	≥32	TNM. 1604..	ATK-01	AKV-01-M5x22	AATN-2-0002	AAV-03-M5x12	-	ABPL-01	AAL-03-3
S32T TTUNR/L 16	●	●	32	30	300	22	≥40								
S25S TTUNR/L 22	●	●	25	23	250	17	≥32	TNM. 2204..	ATK-02	AKV-30-M6x22	AATN-3-0015	AAV-02-M5x12	AS-01	ABPL-01	AAL-03-3
S32T TTUNR/L 22	●	●	32	30	300	22	≥40								
S40U TTUNR/L 22	●	●	40	37.5	350	27	≥50								
S50V TTUNR/L 22	●	●	50	47	400	35	≥63								

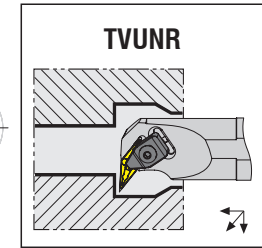
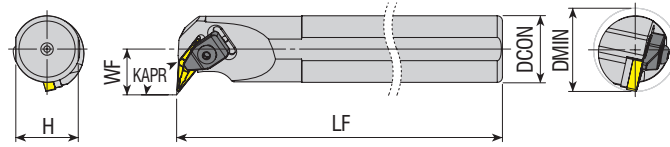

Takım Kodu Ordering Code Bestell-Bezeichnung	Stok Stock Lager		Takım Ölçüleri (mm) Dimension (mm) Abmessung (mm)					Kesici Uç Insert Wendeschneidplatte	Baskı Pabuçu Wedge Clamp Spannpratze	Pabuç Vidası Clamp Screw Klemmschraube	Altlık Shim Unterlage	Altlık Vidası Shim Screw Schraube für Unterlage	Yay Spring Feder	Pul Stamp Ring	Anahtar Allen Key Innerschraubenschlüssel
	R	L	DCON	H	LF	WF	DMIN								
S25S TVUNR/L 16	●	●	25	23	250	20	≥36	VNM. 1604..	ATK-01	AKV-01-M5x22	AAVN-2-0002	AAV-04-M5x12	-	ABPL-01	AAL-03-3
S32T TVUNR/L 16	●	●	32	30	300	22	≥40								
S40U TVUNR/L 16	●	●	40	37.5	350	27	≥50								

R: Sağ / Right / Rechts L: Sol/Left/Links

● Stokta / In Stock / Auf Lager ○ Stokta Yok / Non Stock Item / Kein Lagerartikel, Lieferzeit auf Anfrage

Sipariş Örneği/Ordering Example/Bestellbeispiel

1 ad./pcs./stück S25S TTUNR 16

T-SİSTEM DELİK TORNA KATERLERİ  
T-SYSTEM BORING BARS  
T-SYSTEM BOHRSTANGE

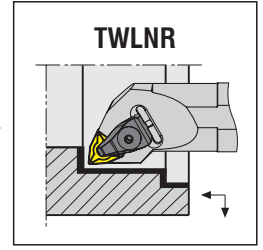
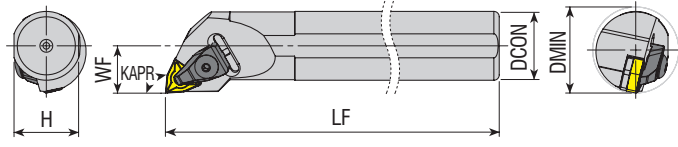

Takım Kodu Ordering Code Bestell-Bezeichnung	Stok Stock Lager		Takım Ölçüleri (mm) Dimension (mm) Abmessung (mm)					Kesici Uç Insert Wendeschneidplatte	Yedek Parçaları / Spare Parts / Ersatzteile						
	R	L	DCON	H	LF	WF	DMIN		Baskı Pabucu Wedge Clamp Spannpratze	Pabuç Vidası Clamp Screw Klemmschraube	Altlık Shim Unterlage	Altlık Vidası Shim Screw Schraube für Unterlage	Sekman Ring Feder	Pul Stamp Ring	Anahtar Allen Key Innensechskantschlüssel
S25S TWLNR/L 06	●	●	25	23	250	17	≥32	WNM. 0604..	ATK-01	AKV-01-M5x22	AAWN-SW317	AAV-01-M3x10	-		
S32T TWLNR/L 06	●	●	32	30	300	22	≥40							AAV-13-M5x8	
S25S TWLNR/L 08	●	●	25	23	250	17	≥32	WNM. 0804..	ATK-02	AKV-30-M6x22	AAWN-3-0001	AAV-02-M5x12	AS-01	ABPL-01	AAL-03-3
S32T TWLNR/L 08	●	●	32	30	300	22	≥40								
S40U TWLNR/L 08	●	●	40	37.5	350	27	≥50								
S50V TWLNR/L 08	●	●	50	47	400	35	≥63								
A40T TWLNR/L 08	●	○	40	37.5	300	27	≥50								
A50U TWLNR/L 08	●	○	50	47	350	35	≥63								

C-SİSTEM DELİK TORNA KATERLERİ  
C-SYSTEM BORING BARS  
C-SYSTEM BOHRSTANGE

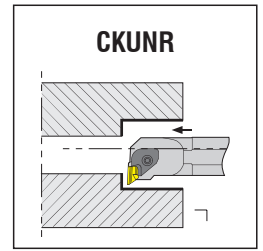
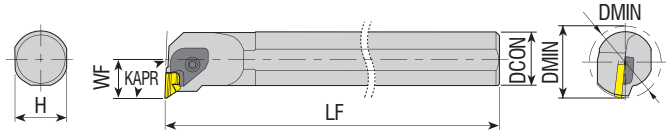

Takım Kodu Ordering Code Bestell-Bezeichnung	Stok Stock Lager		Takım Ölçüleri (mm) Dimension (mm) Abmessung (mm)					Kesici Uç Insert Wendeschneidplatte	Yedek Parçaları / Spare Parts / Ersatzteile							
	R	L	DCON	H	LF	WF	DMIN		Baskı Pabucu Wedge Clamp Spannpratze	Pabuç Vidası Clamp Screw Klemmschraube	Altlık Shim Unterlage	Altlık Vidası Shim Screw Schraube für Unterlage	Yay Spring Feder	Pul Stamp Ring	Anahtar Allen Key Innensechskantschlüssel	
S25S CKUNR/L 16	●	●	25	23	250	19	≥38	KNUX 1604..	ACK-01-R ACK-02-L	AKV-06-M6x20	AKS-16-R	AAV-01-M3x10	AKY-02	ABPL-01	AAL-05-4	
S32T CKUNR/L 16	●	●	32	30	300	22	≥40									
S40U CKUNR/L 16	●	●	40	37.5	350	27	≥50									
S50V CKUNR/L 16	●	●	50	47	400	35	≥63									

R: Sağ / Right / Rechts L: Sol/Left/Links

● Stokta / In Stock / Auf Lager ○ Stokta Yok / Non Stock Item / Kein Lagerartikel, Lieferzeit auf Anfrage

Sipariş Örneği/Ordering Example/Bestellbeispiel

1 ad./pcs./stück S25S TWLNR 06



www.akko.com.tr



# M-SİSTEM

M-SİSTEM DELİK TORNA KATERLERİ  
M-SYSTEM BORING BARS  
M-SYSTEM BOHRSTANGE

*konusulan  
the spoken kalite...  
quality...*



KAPR=95°

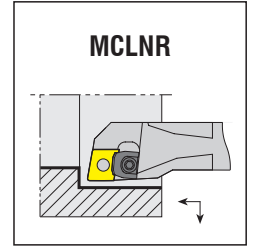
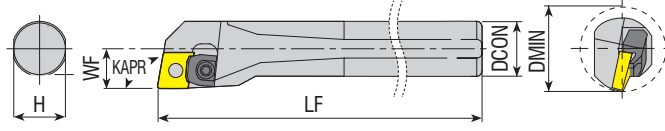

Takım Kodu Ordering Code Bestell-Bezeichnung	Stok Stock Lager		Takım Ölçüleri (mm) Dimension (mm) Abmessung (mm)					Kesici Uç Insert Wendeschneidplatte	Yedek Parçaları / Spare Parts / Ersatzteile						
	R	L	DCON	H	LF	WF	DMIN		Baskı Pabucu Wedge Clamp Spannpratze	Pabuç Vidası Clamp Screw Klemmschraube	Altlık Shim Unterlage	Pim Pin Passstift	Pul Stamp Ring	Anahtar Allen Key Innerschlüssel	
S20R MCLNR/L 12	●	●	20	18.3	200	13	≥25	CNM. 1204..	AMK-07	AKV-04-M5x17	AACN-3-0001	APM-12	-	AAL-03-3	
S25S MCLNR/L 12	●	●	25	23	250	17	≥32		AMK-03			APM-13			
S32T MCLNR/L 12	●	●	32	30	300	22	≥40					APM-04			

KAPR=93°

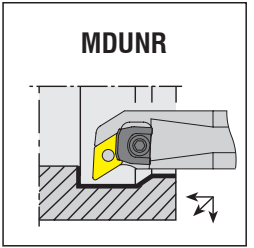
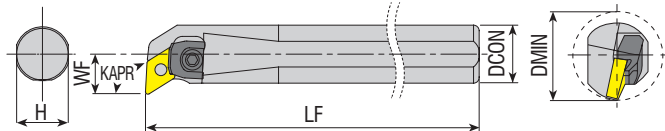

Takım Kodu Ordering Code Bestell-Bezeichnung	Stok Stock Lager		Takım Ölçüleri (mm) Dimension (mm) Abmessung (mm)					Kesici Uç Insert Wendeschneidplatte	Yedek Parçaları / Spare Parts / Ersatzteile						
	R	L	DCON	H	LF	WF	DMIN		Baskı Pabucu Wedge Clamp Spannpratze	Pabuç Vidası Clamp Screw Klemmschraube	Altlık Shim Unterlage	Pim Pin Passstift	Sekman Ring Feder	Pul Stamp Ring	Anahtar Allen Key Innerschlüssel
S20R MDUNR/L 11	●	●	20	18.3	200	13	≥25	DNM. 1104..	AMK-03	AKV-17-M5x15	-	APM-03	-	-	AAL-03-3
S25S MDUNR/L 11	●	●	25	23	250	17	≥32			AKV-04-M5x17					
S32T MDUNR/L 11	○	○	32	30	300	22	≥40								
S25S MDUNR/L 15	●	●	25	23	250	17	≥32	DNM. 1506..	AMK-04	AKV-20-M6x19	AADN-3-0001	APM-04	AS-01	ABPL-01	
S32T MDUNR/L 15	●	●	32	30	300	22	≥40			AKV-30-M6x22					
S40U MDUNR/L 15	●	●	40	37.5	350	27	≥50								
S50V MDUNR/L 15	●	●	50	47	400	35	≥63								

R: Sağ / Right / Rechts L: Sol/Left/Links

● Stokta / In Stock / Auf Lager ○ Stokta Yok / Non Stock Item / Kein Lagerartikel, Lieferzeit auf Anfrage

Sipariş Örneği/Ordering Example/Bestellbeispiel

1 ad./pcs./stück S20R MCLNR 12



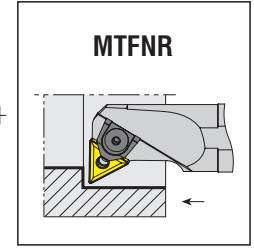
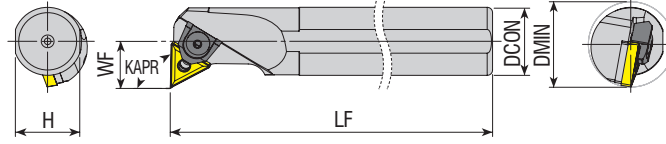
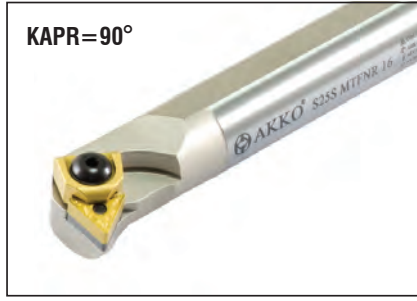

Takım Kodu Ordering Code Bestell-Bezeichnung	Stok Stock Lager		Takım Ölçüleri (mm) Dimension (mm) Abmessung (mm)					Kesici Uç Insert Wendeschneidplatte	Yedek Parçaları / Spare Parts / Ersatzteile								
	R	L	DCON	H	LF	WF	DMIN		Baskı Pabucu Wedge Clamp Spannpratze	Pabuç Vidası Clamp Screw Klemmschraube	Altlık Shim Unterlage	Pim Pin Passstift	Sekman Ring Feder	Pul Stamp Ring	Anahtar Allen Key Inmenschlüssel		
<b>S20R MTFNR/L 16</b>	●	●	20	18.3	200	14	≥25	TNM. 1604..	AMK-02	AKV-17-M5x15	-	APM-03	AS-01	-	-	-	
<b>S25S MTFNR/L 16</b>	●	●	25	23	250	17	≥32					APM-14					
<b>S32T MTFNR/L 16</b>	●	●	32	30	300	22	≥40					AATN-2-0002					APM-01
<b>S40U MTFNR/L 16</b>	●	●	40	37.5	350	27	≥50					AMK-04					AKV-30-M6x22
<b>S32T MTFNR/L 22</b>	●	●	32	30	300	22	≥40	TNM. 2204..	AMK-04	AKV-30-M6x22	AATN-3-0015	APM-02					
<b>S40U MTFNR/L 22</b>	●	●	40	37.5	350	27	≥50										
<b>S50V MTFNR/L 22</b>	●	○	50	47	400	35	≥63										

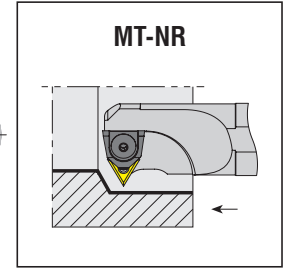
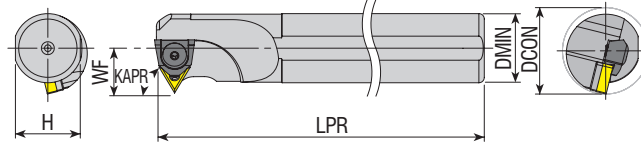

Takım Kodu Ordering Code Bestell-Bezeichnung	Stok Stock Lager		Takım Ölçüleri (mm) Dimension (mm) Abmessung (mm)					Kesici Uç Insert Wendeschneidplatte	Yedek Parçaları / Spare Parts / Ersatzteile							
	R	L	DCON	H	LPR	WF	DMIN		Baskı Pabucu Wedge Clamp Spannpratze	Pabuç Vidası Clamp Screw Klemmschraube	Altlık Shim Unterlage	Pim Pin Passstift	Sekman Ring Feder	Pul Stamp Ring	Anahtar Allen Key Inmenschlüssel	
<b>S20R MT-NR/L 16</b>	●	●	20	18.3	200	16	≥26	TNM. 1604..	AMK-02	AKV-04-M5x17	-	APM-03	AS-01	ABPL-01	AAL-03-3	
<b>S25S MT-NR/L 16</b>	●	●	25	23	250	17	≥32					APM-14				
<b>S32T MT-NR/L 16</b>	●	●	32	30	300	22	≥40					AATN-2-0002				APM-01
<b>S40U MT-NR/L 16</b>	●	●	40	37.5	350	27	≥50					AMK-04				AKV-30-M6x22
<b>S32T MT-NR/L 22</b>	●	●	32	30	300	24	≥40	TNM. 2204..	AMK-04	AKV-30-M6x22	AATN-3-0015	APM-02				
<b>S40U MT-NR/L 22</b>	●	●	40	37.5	350	27	≥50									
<b>S50U MT-NR/L 22</b>	●	●	50	47	350	35	≥63									

R: Sağ / Right / Rechts L: Sol/Left/Links  
● Stokta / In Stock / Auf Lager ○ Stokta Yok / Non Stock Item / Kein Lagerartikel, Lieferzeit auf Anfrage

Sipariş Örneği/Ordering Example/Bestellbeispiel  
1 ad./pcs./stück S20R MTFNR 16

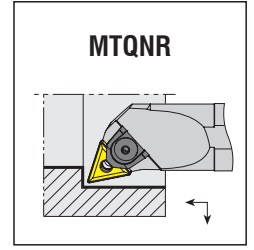
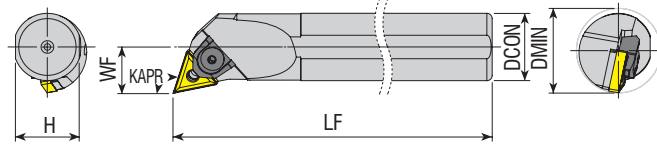

Takım Kodu Ordering Code Bestell-Bezeichnung	Stok Stock Lager		Takım Ölçüleri (mm) Dimension (mm) Abmessung (mm)					Kesici Uç Insert Wendeschneidplatte	Yedek Parçaları / Spare Parts / Ersatzteile						
	R	L	DCON	H	LF	WF	DMIN		Baskı Pabucu Wedge Clamp Spannpratze	Pabuç Vidası Clamp Screw Klemmschraube	Altlık Shim Unterlage	Pim Pin Passstift	Sekman Ring Feder	Pul Stamp Ring	Anahtar Allen Key Innensechskantschlüssel
S20R MTQNR/L 16	●	●	20	18.3	200	13	≥25	TNM. 1604..	AMK-02	AKV-17-M5x15	-	APM-11	-	-	
S25S MTQNR/L 16	●	●	25	23	250	17	≥32				AATN-2-0002	APM-14			
S32T MTQNR/L 16	●	●	32	30	300	22	≥40					APM-01			
S40U MTQNR/L 16	●	●	40	37.5	350	27	≥50	TNM. 2204..	AMK-04	AKV-30-M6x22			AS-01	ABPL-01	AAL-03-3
S32T MTQNR/L 22	●	●	32	30	300	22	≥40				AATN-3-0015	APM-02			
S40U MTQNR/L 22	●	●	40	37.5	350	27	≥50								
S50V MTQNR/L 22	●	●	50	47	400	35	≥63								

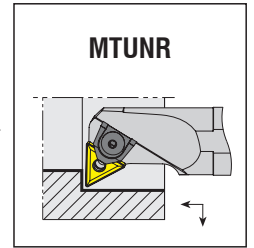
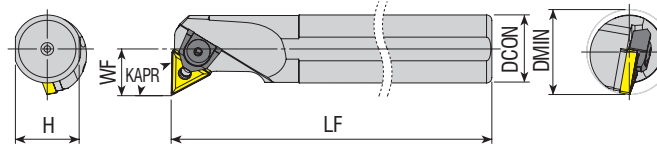

Takım Kodu Ordering Code Bestell-Bezeichnung	Stok Stock Lager		Takım Ölçüleri (mm) Dimension (mm) Abmessung (mm)					Kesici Uç Insert Wendeschneidplatte	Yedek Parçaları / Spare Parts / Ersatzteile						
	R	L	DCON	H	LF	WF	DMIN		Baskı Pabucu Wedge Clamp Spannpratze	Pabuç Vidası Clamp Screw Klemmschraube	Altlık Shim Unterlage	Pim Pin Passstift	Sekman Ring Feder	Pul Stamp Ring	Anahtar Allen Key Innensechskantschlüssel
S20R MTUNR/L 16	●	●	20	18.3	200	13	≥25	TNM. 1604..	AMK-02	AKV-17-M5x15	-	APM-03	-	-	
S25S MTUNR/L 16	●	●	25	23	250	17	≥32				AATN-2-0002	APM-14			
S32T MTUNR/L 16	●	●	32	30	300	22	≥40					APM-01			
S40U MTUNR/L 16	●	●	40	37.5	350	27	≥50	TNM. 2204..	AMK-04	AKV-30-M6x22			AS-01	ABPL-01	AAL-03-3
S50V MTUNR/L 16	●	●	50	47	400	35	≥63				AATN-3-0015	APM-02			
S32T MTUNR/L 22	●	●	32	30	300	22	≥40								
S40U MTUNR/L 22	●	●	40	37.5	350	27	≥50								
S50V MTUNR/L 22	●	●	50	47	400	35	≥63								

R: Sağ / Right / Rechts L: Sol/Left/Links

● Stokta / In Stock / Auf Lager ○ Stokta Yok / Non Stock Item / Kein Lagerartikel, Lieferzeit auf Anfrage

Sipariş Örneği/Ordering Example/Bestellbeispiel

1 ad./pcs./stück S20R MTQNR 16

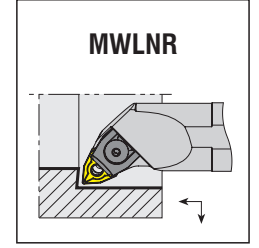
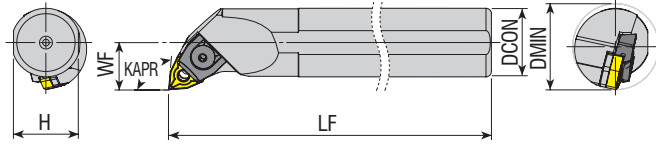

Takım Kodu Ordering Code Bestell-Bezeichnung	Stok Stock Lager		Takım Ölçüleri (mm) Dimension (mm) Abmessung (mm)				Kesici Uç Insert Wendeschneidplatte	Baskı Pabucu Wedge Clamp Spannpratze	Pabuç Vidası Clamp Screw Klemmschraube	Yedek Parçaları / Spare Parts / Ersatzteile					
	R	L	DCON	H	LF	WF				DMIN	Altık Shim Unterlage	Pim Pin Passstift	Sekman Ring Feder	Pul Stamp Ring	Anahtar Allen Key Inmenschlüssel
S16P MWLNR/L 06	●	●	16	14.8	170	11	≥20	WNM. 0604..	AMK-01	AKV-17-M5x15	-	APM-09	-	-	AAL-03-3
S20R MWLNR/L 06	●	●	20	18.3	200	13	≥25			AKV-04-M5x17		APM-10			
S25S MWLNR/L 06	●	●	25	23	250	17	≥32			AKV-27-M6x20		APM-08			
S25S MWLNR/L 08	●	●	25	23	250	17	≥32	WNM. 0804..	AMK-05	AKV-03-M6x22	AAWN-3-0001	APM-04	AS-01	ABPL-01	
S32T MWLNR/L 08	●	●	32	30	300	22	≥40			APM-02					
S40U MWLNR/L 08	●	●	40	37.5	350	27	≥50								

R: Sağ / Right / Rechts L: Sol/Left/Links

● Stokta / In Stock / Auf Lager ○ Stokta Yok / Non Stock Item / Kein Lagerartikel, Lieferzeit auf Anfrage

Sipariş Örneği/Ordering Example/Bestellbeispiel

1 ad./pcs./stück S16P MWLNR 06







*konusulan  
the spoken kalite...  
quality...*

# P-SİSTEM

**P-SİSTEM DELİK TORNA KATERLERİ**  
P-SYSTEM BORING BARS  
P-SYSTEM BOHRSTANGE





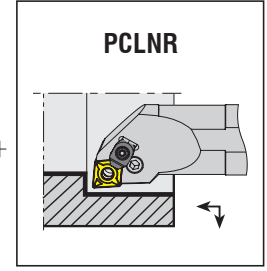
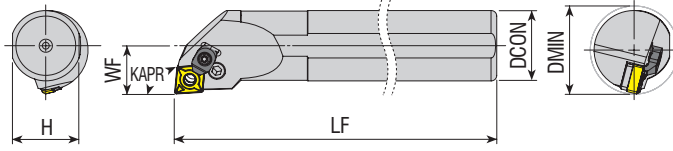

Takım Kodu Ordering Code Bestell-Bezeichnung	Stok Stock Lager		Takım Ölçüleri (mm) Dimension (mm) Abmessung (mm)					Kesici Uç Insert Wendeschneidplatte	Yedek Parçaları / Spare Parts / Ersatzteile						
	R	L	DCON	H	LF	WF	DMIN		Leyve Lever Kniehebel	Leyve Vidası Lever Screw Kniehebelschraube	Altlık Shim Unterlage	Altlık Yayı Shim Spring Feder für Unterlage	Baskı Pabuçu Wedge Clamp Spannpratze	Pabuç Vidası Clamp Screw Klemmschraube	Anahtar Allen Key Innerschlüsselschlüssel
S16P PCLNR/L 09	●	●	16	14.8	170	11	≥20	CNM. 0903..	APL-07	ALV-07-M6x13	-	AAV-07	-	-	AAL-02-2.5
S20R PCLNR/L 09	●	●	20	18.3	200	13	≥25		APL-01	ALV-02-M6x17	AACN-2-0002	AAV-01	-	-	AAL-02-2.5
S25S PCLNR/L 09	●	○	25	23	250	17	≥32			ALV-08-M8x16					
S25S PCLNR/L 12C	●	●	25	23	250	17	≥32	CNM. 1204..	APL-02	ALV-03-M8x19	AACN-3-0001	AAV-02	ACK-05	4015-M4x11	AAL-03-3
S32T PCLNR/L 12C	●	●	32	30	300	22	≥40								
S40U PCLNR/L 12C	●	●	40	37.5	350	27	≥50								
S50V PCLNR/L 12C	●	●	50	47	400	35	≥63	CNM. 1606..	APL-04	ALV-04-M8x22	AACN-3-0002	AAV-03	ACK-09	AAV-05-M6x15	
S32T PCLNR/L 16C	●	●	32	30	300	22	≥40								
S40U PCLNR/L 16C	●	●	40	37.5	350	27	≥50								
S50V PCLNR/L 16C	●	●	50	47	400	35	≥63	CNM. 1906..	APL-05	ALV-05-M10x27	AACN-3-0003	AAV-04	ACK-09	AAV-05-M6x15	AAL-05-4
S40U PCLNR/L 19C	●	●	40	37.5	350	27	≥50								
S50V PCLNR/L 19C	●	●	50	47	400	35	≥63								
A20P PCLNR/L 09	●	●	20	18.3	170	13	≥25	CNM. 0903..	APL-01	ALV-02-M6x17	AACN-2-0002	AAV-01	-	-	AAL-02-2.5
A25R PCLNR/L 12C	●	●	25	23	200	17	≥32			ALV-08-M8x16					
A32S PCLNR/L 12C	●	●	32	30	250	22	≥40		APL-02	ALV-03-M8x19	AACN-3-0001	AAV-02	ACK-05	4015-M4x11	AAL-03-3
A40T PCLNR/L 12C	●	●	40	37.5	300	27	≥50	CNM. 1606..	APL-04	ALV-04-M8x22	AACN-3-0002	AAV-03	ACK-09	AAV-05-M6x15	
A50U PCLNR/L 12C	●	●	50	47	350	35	≥63								
A32S PCLNR/L 16C	●	●	32	30	250	22	≥40								
A40T PCLNR/L 16C	●	●	40	37.5	300	27	≥50	CNM. 1906..	APL-05	ALV-05-M10x27	AACN-3-0003	AAV-04	ACK-09	AAV-05-M6x15	AAL-05-4
A50U PCLNR/L 16C	●	●	50	47	350	35	≥63								
A40T PCLNR/L 19C	●	●	40	37.5	300	27	≥50								
A50U PCLNR/L 19C	●	●	50	47	350	35	≥63								

R: Sağ / Right / Rechts L: Sol/Left/Links

● Stokta / In Stock / Auf Lager ○ Stokta Yok / Non Stock Item / Kein Lagerartikel, Lieferzeit auf Anfrage

Sipariş Örneği/Ordering Example/Bestellbeispiel

1 ad./pcs./stück S16P PCLNR 09

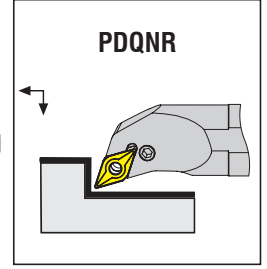
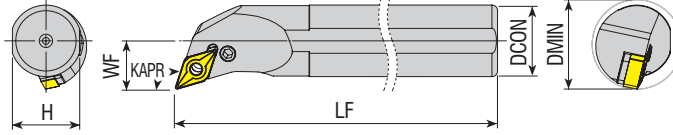

Takım Kodu Ordering Code Bestell-Bezeichnung	Stok Stock Lager		Takım Ölçüleri (mm) Dimension (mm) Abmessung (mm)					Kesici Uç Insert Wendeschneidplatte	Yedek Parçaları / Spare Parts / Ersatzteile						
	R	L	DCON	H	LF	WF	DMIN		Levyeye Lever Kniehebel	Levyeye Vidası Lever Screw Kniehebelschraube	Altılık Shim Unterlage	Altılık Yay Shim Spring Feder für Unterlage	Baskı Pabuçu Wedge Clamp Spannpratze	Pabuç Vidası Clamp Screw Klemmschraube	Anahtar Allen Key Innensechskantschlüssel
S20R PDQNR/L 11	●	○	20	18.3	200	13	≥25	DNM. 1104..	APL-01	ALV-01-M6x14 ALV-02-M6x17	AADN-SD317	AAY-01			AAL-02-2.5
S25S PDQNR/L 11	●	●	25	23	250	17	≥32								
S32T PDQNR/L 15	●	●	32	30	300	22	≥40	DNM. 1506..	APL-03	ALV-03-M8x19	AADN-3-0001	AAY-02	-	-	AAL-03-3
S40U PDQNR/L 15	●	●	40	37.5	350	27	≥50								
S50V PDQNR/L 15	●	●	50	47	400	35	≥63	DNM. 1504..	APL-03	ALV-03-M8x19	AADN-2-0003	AAY-02	-	-	AAL-03-3
S32T PDQNR/L 1504	●	●	32	30	300	22	≥40								
S40U PDQNR/L 1504	●	●	40	37.5	350	27	≥50	DNM. 1104..	APL-01	ALV-01-M6x14 ALV-02-M6x17	AADN-SD317	AAY-01	-	-	AAL-02-2.5
S50V PDQNR/L 1504	●	●	50	47	400	35	≥63								
A20P PDQNR/L 11	●	●	20	18.3	170	13	≥25	DNM. 1506..	APL-03	ALV-03-M8x19	AADN-3-0001	AAY-02	-	-	AAL-03-3
A25R PDQNR/L 11	●	●	25	23	200	17	≥32								
A32S PDQNR/L 15	●	●	32	30	250	22	≥40	DNM. 1504..	APL-03	ALV-03-M8x19	AADN-2-0003	AAY-02	-	-	AAL-03-3
A40T PDQNR/L 15	●	●	40	37.5	300	27	≥50								
A50U PDQNR/L 15	●	●	50	47	350	35	≥63	DNM. 1506..	APL-03	ALV-03-M8x19	AADN-3-0001	AAY-02	-	-	AAL-03-3
A32S PDQNR/L 1504	●	●	32	30	250	22	≥40								
A40T PDQNR/L 1504	●	●	40	37.5	300	27	≥50								

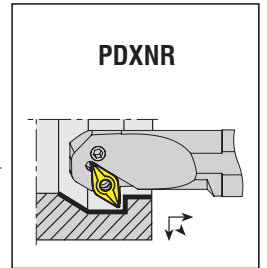
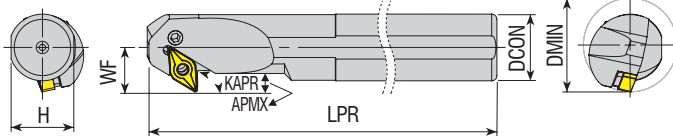

Takım Kodu Ordering Code Bestell-Bezeichnung	Stok Stock Lager		Takım Ölçüleri (mm) Dimension (mm) Abmessung (mm)					Kesici Uç Insert Wendeschneidplatte	Yedek Parçaları / Spare Parts / Ersatzteile							
	R	L	DCON	H	LPR	WF	APMX		DMIN	Levyeye Lever Kniehebel	Levyeye Vidası Lever Screw Kniehebelschraube	Altılık Shim Unterlage	Altılık Yay Shim Spring Feder für Unterlage	Baskı Pabuçu Wedge Clamp Spannpratze	Pabuç Vidası Clamp Screw Klemmschraube	Anahtar Allen Key Innensechskantschlüssel
S32T PDXNR/L 15	●	●	32	30	300	22	12	≥45	DNM. 1506..	APL-03	ALV-08-M8x16	AADN-3-0001	AAY-02	-	-	AAL-03-3
S40U PDXNR/L 15	●	●	40	37.5	350	27	14	≥50								
S50V PDXNR/L 15	●	●	50	47	400	35	19	≥63								
A32S PDXNR/L 15	●	●	32	30	250	22	12	≥40								
A40T PDXNR/L 15	●	●	40	37.5	300	27	14	≥50								
A50U PDXNR/L 15	●	●	50	47	350	35	19	≥63								

R: Sağ / Right / Rechts L: Sol/Left/Links

● Stokta / In Stock / Auf Lager ○ Stokta Yok / Non Stock Item / Kein Lagerartikel, Lieferzeit auf Anfrage

Not: "APMX" ölçüleri R0.8'e göre verilmiştir. Note: Dimensions of "APMX" are given according to R.08. Hinweis: Maß "APMX" gilt für Eckenradius 0,8 mm

Sipariş Örneği/Ordering Example/Bestellbeispiel

1 ad./pcs./stück S20R PDQNR 11

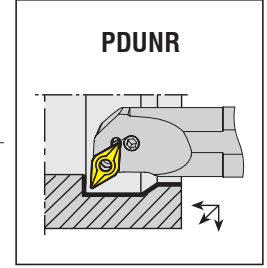
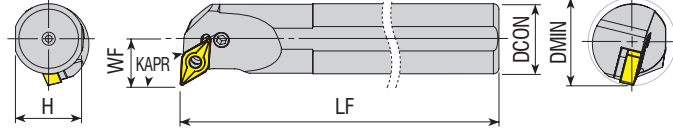

Takım Kodu Ordering Code Bestell-Bezeichnung	Stok Stock Lager		Takım Ölçüleri (mm) Dimension (mm) Abmessung (mm)					Kesici Uç Insert Wendeschneidplatte	Yedek Parçaları / Spare Parts / Ersatzteile						
	R	L	DCON	H	LF	WF	DMIN		Leyve Lever Kniehebel	Leyve Vidası Lever Screw Kniehebelschraube	Altlık Shim Unterlage	Altlık Yay Shim Spring Feder für Unterlage	Baskı Pabuç Wedge Clamp Spannpratze	Pabuç Vidası Clamp Screw Klemmschraube	Anahtar Allen Key Inmenschlüssel
	●	●													
S20R PDUNR/L 11	●	●	20	18.3	200	13	≥25	DNM. 1104..	APL-01	ALV-01-M6x14 ALV-02-M6x17 ALV-08-M8x16	AADN-SD317	AAY-01	-	-	AAL-02-2.5
S25S PDUNR/L 11	●	●	25	23	250	17	≥32								
S25S PDUNR/L 15	●	●	25	23	250	19	≥32								
S32T PDUNR/L 15	●	●	32	30	300	22	≥40	DNM. 1506..	APL-03	ALV-03-M8x19	AADN-3-0001	AAY-02	-	-	AAL-03-3
S40U PDUNR/L 15	●	●	40	37.5	350	27	≥50								
S50V PDUNR/L 15	●	●	50	47	400	35	≥63								
A20P PDUNR/L 11	●	●	20	18.3	170	13	≥25	DNM. 1104..	APL-01	ALV-01-M6x14 ALV-02-M6x17	AADN-SD317	AAY-01	-	-	AAL-02-2.5
A25R PDUNR/L 11	●	●	25	23	200	17	≥32								
A32S PDUNR/L 11	●	●	32	30	250	22	≥40								
A32S PDUNR/L 15	●	●	32	30	250	22	≥40	DNM. 1506..	APL-03	ALV-03-M8x19	AADN-3-0001	AAY-02	-	-	AAL-03-3
A40T PDUNR/L 15	●	●	40	37.5	300	27	≥50								
A50U PDUNR/L 15	●	●	50	47	350	35	≥63								

R: Sağ / Right / Rechts L: Sol/Left/Links

● Stokta / In Stock / Auf Lager ○ Stokta Yok / Non Stock Item / Kein Lagerartikel, Lieferzeit auf Anfrage

Sipariş Örneği/Ordering Example/Bestellbeispiel

1 ad./pcs./stück S20R PDUNR 11



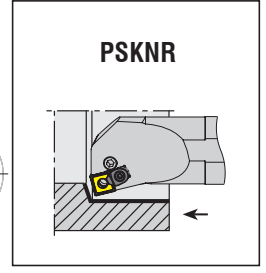
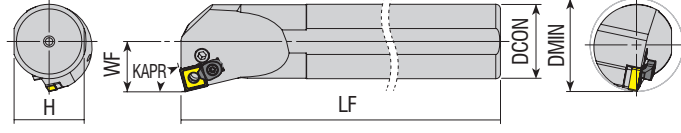

Takım Kodu Ordering Code Bestell-Bezeichnung	Stok Stock Lager		Takım Ölçüleri (mm) Dimension (mm) Abmessung (mm)					Kesici Uç Insert Wendeschneidplatte	Yedek Parçaları / Spare Parts / Ersatzteile						
	R	L	DCON	H	LF	WF	DMIN		Levyeye Lever Kniehebel	Levyeye Vidası Lever Screw Kniehebelschraube	Altılık Shim Unterlage	Altılık Yayılı Shim Spring Feder für Unterlage	Baskı Pabucu Wedge Clamp Spannpratze	Pabuç Vidası Clamp Screw Klemmschraube	Anahtar Allen Key Innensechskantschlüssel
S25S PSKNR/L 12C	●	●	25	23	250	17	≥32	SNM. 1204..	APL-02	ALV-03-M8x19	AASN-3-0004	AAY-02	ACK-05	4015-M4x11	AAL-03-3
S32T PSKNR/L 12C	●	●	32	30	300	22	≥40								
S40U PSKNR/L 12C	●	●	40	37.5	350	27	≥50								
S50V PSKNR/L 12C	●	●	50	47	400	35	≥63								
S32T PSKNR/L 15C	○	○	32	30	300	22	≥40	SNM. 1506..	APL-04	ALV-04-M8x22	AASN-3-0023	AAY-03	ACK-09	AAV-05-M6x15	
S40U PSKNR/L 15C	○	○	40	37.5	350	27	≥50								
S50V PSKNR/L 15C	○	○	50	47	400	35	≥63								
A25R PSKNR/L 12C	●	●	25	23	200	17	≥32	SNM. 1204..	APL-02	ALV-03-M8x19	AASN-3-0004	AAY-02	ACK-05	4015-M4x11	
A32S PSKNR/L 12C	●	●	32	30	250	22	≥40								
A40T PSKNR/L 12C	●	●	40	37.5	300	27	≥50								
A50U PSKNR/L 12C	○	○	50	47	350	35	≥63								
A32S PSKNR/L 15C	●	●	32	30	250	22	≥40	SNM. 1506..	APL-04	ALV-04-M8x22	AASN-3-0023	AAY-03	ACK-09	AAV-05-M6x15	
A40T PSKNR/L 15C	●	●	40	37.5	300	27	≥50								
A50U PSKNR/L 15C	●	●	50	47	350	35	≥63								



KAPR=90°

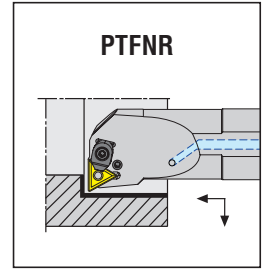
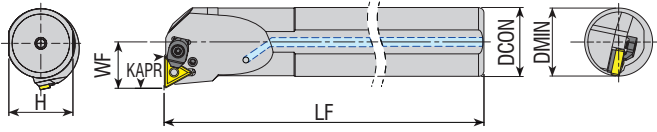

Takım Kodu Ordering Code Bestell-Bezeichnung	Stok Stock Lager		Takım Ölçüleri (mm) Dimension (mm) Abmessung (mm)					Kesici Uç Insert Wendeschneidplatte	Yedek Parçaları / Spare Parts / Ersatzteile						
	R	L	DCON	H	LF	WF	DMIN		Levyeye Lever Kniehebel	Levyeye Vidası Lever Screw Kniehebelschraube	Altılık Shim Unterlage	Altılık Yayılı Shim Spring Feder für Unterlage	Baskı Pabucu Wedge Clamp Spannpratze	Pabuç Vidası Clamp Screw Klemmschraube	Anahtar Allen Key Innensechskantschlüssel
A25R PTFNR/L 16C	●	●	25	23	200	17	≥32	TNM. 1604..	APL-01	ALV-02-M6x17	AATN-3-0025	AAY-01	ACK-05	4015-M4x11	AAL-03-3
A32S PTFNR/L 16C	●	●	32	30	250	22	≥40								

R: Sağ / Right / Rechts L: Sol/Left/Links  
● Stokta / In Stock / Auf Lager ○ Stokta Yok / Non Stock Item / Kein Lagerartikel, Lieferzeit auf Anfrage

Sipariş Örneği/Ordering Example/Bestellbeispiel  
1 ad./pcs./stück S25S PSKNR 12C



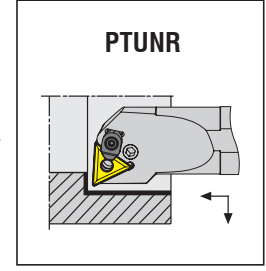
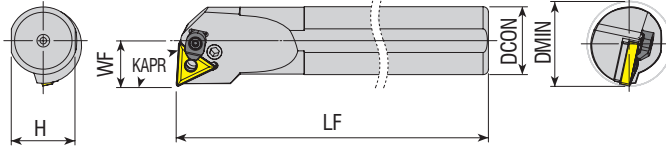
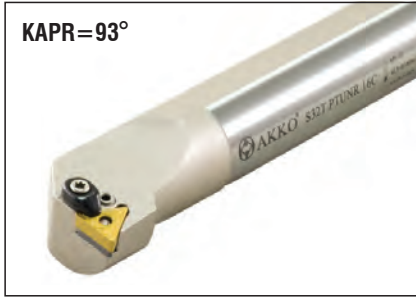

Takım Kodu Ordering Code Bestell-Bezeichnung	Stok Stock Lager		Takım Ölçüleri (mm) Dimension (mm) Abmessung (mm)				Kesici Uç Insert Wendeschneidplatte	Yedek Parçaları / Spare Parts / Ersatzteile												
	R	L	DCON	H	LF	WF		DMIN	Leyve Lever Kniehebel	Leyve Vidası Lever Screw Kniehebelschraube	Altlık Shim Unterlage	Altlık Yay Shim Spring Feder für Unterlage	Baskı Pabuç Wedge Clamp Spannpratze	Pabuç Vidası Clamp Screw Klemmschraube	Anahtar Allen Key Innensechskantschlüssel					
	●	●																		
<b>S16P PTUNR/L 16</b>	●	●	16	14.8	170	11	≥20	<b>TNM. 1604..</b>	APL-08	ALV-07-M6x13	-	AAV-07	-	-	AAL-02-2.5					
<b>S20R PTUNR/L 16</b>	●	●	20	18.3	200	13	≥25		APL-01	ALV-01-M6x14	AATN-3-0025	AAV-01								
<b>S25S PTUNR/L 16C</b>	●	●	25	23	250	17	≥32			ALV-02-M6x17										
<b>S32T PTUNR/L 16C</b>	●	●	32	30	300	22	≥40		APL-02	ALV-03-M8x19	AATN-3-0015	AAV-02	ACK-05	4015-M4x11						
<b>S40U PTUNR/L 16C</b>	●	●	40	37.5	350	27	≥50													
<b>S32T PTUNR/L 22C</b>	●	●	32	30	300	22	≥40													
<b>S40U PTUNR/L 22C</b>	●	●	40	37.5	350	27	≥50	<b>TNM. 2204..</b>	APL-08	ALV-07-M6x13	-	AAV-07	-	-						
<b>S50V PTUNR/L 22C</b>	●	●	50	47	400	35	≥63													
<b>A16M PTUNR/L 16</b>	●	●	16	14.8	150	11	≥20								APL-01	ALV-01-M6x14	AATN-3-0025	AAV-01		AAL-02-2.5
<b>A20P PTUNR/L 16</b>	●	●	20	18.3	170	13	≥25													
<b>A25R PTUNR/L 16C</b>	●	●	25	23	200	17	≥32								APL-02	ALV-03-M8x19	AATN-3-0015	AAV-02	ACK-05	4015-M4x11
<b>A32S PTUNR/L 16C</b>	●	●	32	30	250	22	≥40													
<b>A40T PTUNR/L 16C</b>	●	●	40	37.5	300	27	≥50													
<b>A32S PTUNR/L 22C</b>	●	●	32	30	250	22	≥40	<b>TNM. 2204..</b>	APL-02	ALV-03-M8x19	AATN-3-0015	AAV-02	ACK-05	4015-M4x11	AAL-03-3					
<b>A40T PTUNR/L 22C</b>	●	●	40	37.5	300	27	≥50													

R: Sağ / Right / Rechts L: Sol/Left/Links  
● Stokta / In Stock / Auf Lager ○ Stokta Yok / Non Stock Item / Kein Lagerartikel, Lieferzeit auf Anfrage

Sipariş Örneği/Ordering Example/Bestellbeispiel  
1 ad./pcs./stück S16P PTUNR 16



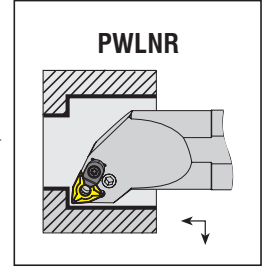
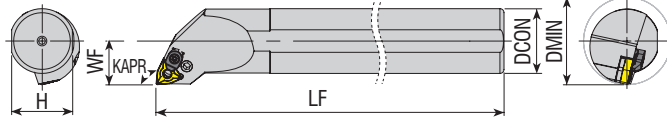

Takım Kodu Ordering Code Bestell-Bezeichnung	Stok Stock Lager		Takım Ölçüleri (mm) Dimension (mm) Abmessung (mm)				Kesici Uç Insert Wendeschneidplatte	Yedek Parçaları / Spare Parts / Ersatzteile							
	R	L	DCON	H	LF	WF		DMIN	Leyve Lever Kniehebel	Leyve Vidası Lever Screw Kniehebschraube	Altık Shim Unterlage	Altık Yay Shim Spring Feder für Unterlage	Baskı Pabuçu Wedge Clamp Spannpratze	Pabuç Vidası Clamp Screw Klemmschraube	Anahtar Allen Key Innensechskantschlüssel
S20R PWLNR/L 06	●	●	20	18.3	200	13	≥25	WNM. 0604..	APL-01	ALV-01-M6x14 ALV-02-M6x17	AAWN-SW317	AAY-01	-	-	AAL-02-2.5
S25S PWLNR/L 06	●	●	25	23	250	17	≥32								
S32T PWLNR/L 06	●	●	32	30	300	22	≥40								
S25S PWLNR/L 08C	●	●	25	23	250	17	≥32								
S32T PWLNR/L 08C	●	●	32	30	300	22	≥40	WNM. 0804..	APL-02	ALV-03-M8x19	AAWN-3-0001	AAY-02	ACK-05	4015-M4x11	AAL-03-3
S40U PWLNR/L 08C	●	●	40	37.5	350	27	≥50								
S50V PWLNR/L 08C	●	●	50	47	400	35	≥63								
A16M PWLNR/L 06	●	●	16	14.8	150	11	≥20	WNM. 0604..	APL-01	ALV-01-M6x14 ALV-02-M6x17	AAWN-SW317	AAY-01	-	-	AAL-02-2.5
A20P PWLNR/L 06	●	●	20	18.3	170	13	≥25								
A25R PWLNR/L 06	●	●	25	23	200	17	≥32								
A32S PWLNR/L 06	●	●	32	30	250	22	≥40								
A40T PWLNR/L 06	●	○	40	37.5	300	27	≥50	WNM. 0804..	APL-02	ALV-03-M8x19	AAWN-3-0001	AAY-02	ACK-05	4015-M4x11	AAL-03-3
A25R PWLNR/L 08C	●	●	25	23	200	17	≥32								
A32S PWLNR/L 08C	●	●	32	30	250	22	≥40								
A40T PWLNR/L 08C	●	●	40	37.5	300	27	≥50								
A50U PWLNR/L 08C	●	●	50	47	350	35	≥63								

R: Sağ / Right / Rechts L: Sol/Left/Links

● Stokta / In Stock / Auf Lager ○ Stokta Yok / Non Stock Item / Kein Lagerartikel, Lieferzeit auf Anfrage

Sipariş Örneği/Ordering Example/Bestellbeispiel

1 ad./pcs./stück S20R PWLNR 06



*konusulan  
the spoken kalite...  
quality...*

# S-SİSTEM

**S-SİSTEM DELİK TORNA KATERLERİ**  
*S-SYSTEM BORING BARS*  
*S-SYSTEM BOHRSTANGE*



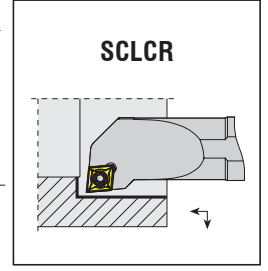
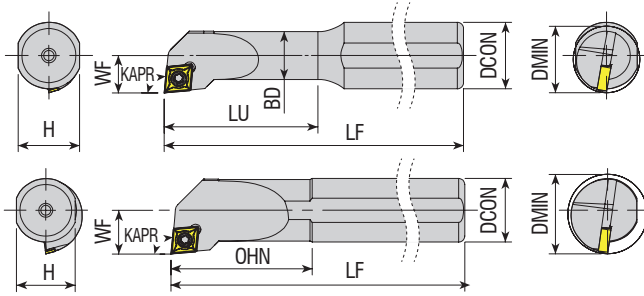

**Takım Kodu**  
**Ordering Code**  
**Bestell-Bezeichnung**

Stok Stock Lager	Takım Ölçüleri (mm) Dimension (mm) Abmessung (mm)								Kesici Uç Insert Wendeschneidplatte	Yedek Parçaları / Spare Parts / Ersatzteile						
	R	L	DCON	BD	H	LU=OHN	LF	WF		DMIN	Sıkma Vidası Screw Schraube	Altlık Shim Unterlage	Altlık Vidası Shim Screw Schraube für Unterlage	Tork Anahtar Torx Key Torx-Schlüssel		
	●	○	08	5	7.3	18	100	3	≥6	CC.T 030102	4006-M1.6x3.2			80-T06		
S0608H SCLCR/L 03			08	5	7.3	18	100	3	≥6		4008-M2.5x4.5					
S0608H SCLCR/L 06	●	●	08	6	7.3	25	100	4.5	≥8							
S08H SCLCR/L 06	●	●	08	8	7.3	20	100	06	≥11							
S10K SCLCR/L 06	●	●	10	10	09	25	125	07	≥13		CC.T 0602..	4008-M2.5x6	-		-	80-T08
S12K SCLCR/L 06	●	●	12	12	11	25	125	09	≥16							
S1216P SCLCR/L 06	●	●	16	11.5	14.8	37	170	09	≥16							
S16P SCLCR/L 06	●	●	16	16	14.8	35	170	11	≥20							
S12K SCLCR/L 09	●	●	12	12	11	30	125	09	≥16	CC.T 09T3..	4015-M3.5x8			80-T15		
S1416P SCLCR/L 09	●	●	16	14	14.8	45	170	9.5	≥17							
S16P SCLCR/L 09	●	●	16	16	14.8	35	170	11	≥20							
S1620R SCLCR/L 09	●	●	20	16	18.3	50	200	11	≥20							
S20R SCLCR/L 09	●	●	20	20	18.3	40	200	13	≥25							
S25S SCLCR/L 09	●	●	25	25	23	50	250	17	≥32		4015-M3.5x12	AACN-2-0001	AAV-08-M3.5x8			
S32T SCLCR/L 09	●	●	32	32	30	60	300	22	≥40							
S25S SCLCR/L 12	●	●	25	25	23	50	250	17	≥32	CC.T 1204..	4020-M4.5x12	AACN-2-0003	AAV-10-M4.5x8	80-T20		
S32T SCLCR/L 12	●	●	32	32	30	60	300	22	≥40		1020-M4.5x16		AAV-07-M4.5x13			
S40U SCLCR/L 12	●	●	40	40	37.5	70	350	27	≥50							
A08H SCLCR/L 06	●	●	08	8	7.3	20	100	06	≥11	CC.T 0602..	4008-M2.5x6	-	-	80-T08		
A10H SCLCR/L 06	●	●	10	10	09	25	100	07	≥13							
A12H SCLCR/L 06	●	●	12	12	11	25	100	09	≥16							
A16M SCLCR/L 09	●	●	16	16	14.8	35	150	11	≥20		4015-M3.5x9	-	-			
A20P SCLCR/L 09	●	●	20	20	18.3	40	170	13	≥25	CC.T 09T3..	4015-M3.5x12	AACN-2-0001	AAV-08-M3.5x8	80-T15		
A25R SCLCR/L 09	●	●	25	25	23	50	200	17	≥32							
A32S SCLCR/L 09	●	●	32	32	30	60	250	22	≥40							
A25R SCLCR/L 12	●	●	25	25	23	50	200	17	≥32	CC.T 1204..	4020-M4.5x12	AACN-2-0003	AAV-10-M4.5x8	80-T20		

R: Sağ / Right / Rechts L: Sol/Left/Links

● Stokta / In Stock / Auf Lager ○ Stokta Yok / Non Stock Item / Kein Lagerartikel, Lieferzeit auf Anfrage

Sipariş Örneği/Ordering Example/Bestellbeispiel

1 ad./pcs./stück S0608H SCLCR 03



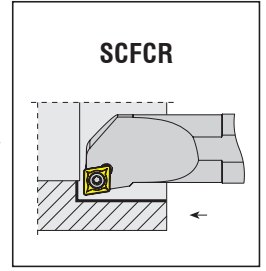
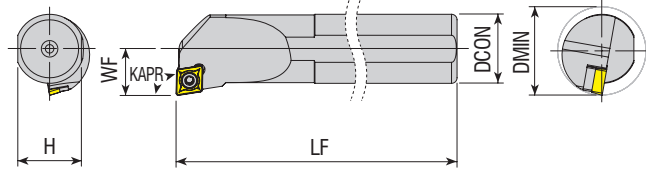

Takım Kodu Ordering Code Bestell-Bezeichnung	Stok Stock Lager		Takım Ölçüleri (mm) Dimension (mm) Abmessung (mm)				Kesici Uç Insert Wendeschneidplatte	Yedek Parçaları / Spare Parts / Ersatzteile				
	R	L	DCON	H	LF	WF		DMIN	Sıkma Vidası Screw Schraube	Altlık Shim Unterlage	Altlık Vidası Shim Screw Schraube für Unterlage	Tork Anahtar Torx Key Torx-Schlüssel
S08H SCFCR/L 06	●	●	08	7.3	100	06	≥11	CC.T 0602..	4008-M2.5x6	-	-	80-T08
S10K SCFCR/L 06	●	●	10	09	125	07	≥13					
S12K SCFCR/L 06	●	●	12	11	125	09	≥16					
S12K SCFCR/L 09	●	●	12	11	125	09	≥16					
S16P SCFCR/L 09	●	●	16	14.8	170	11	≥20	CC.T 09T3..	4015-M3.5x8	-	-	80-T15
S20R SCFCR/L 09	●	●	20	18.3	200	13	≥25					
S25S SCFCR/L 09	●	●	25	23	250	17	≥32					
S25S SCFCR/L 12	●	○	25	23	250	17	≥32	CC.T 1204..	4020-M4.5x12	AACN-2-0003	AAV-10-M4.5x8	80-T20
S32T SCFCR/L 12	○	○	32	30	300	22	≥40		1020-M4.5x16		AAV-07-M4.5x13	
S40U SCFCR/L 12	○	○	40	37.5	350	27	≥50	CC.T 0602..	4008-M2.5x6	-	-	80-T08
A08H SCFCR/L 06	●	○	08	7.3	100	06	≥11					

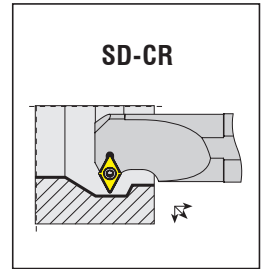
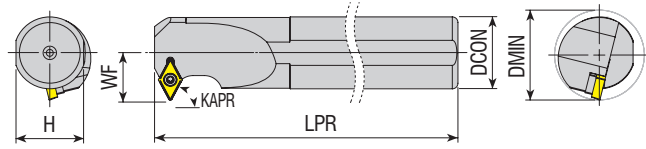

Takım Kodu Ordering Code Bestell-Bezeichnung	Stok Stock Lager		Takım Ölçüleri (mm) Dimension (mm) Abmessung (mm)				Kesici Uç Insert Wendeschneidplatte	Yedek Parçaları / Spare Parts / Ersatzteile				
	R	L	DCON	H	LPR	WF		DMIN	Sıkma Vidası Screw Schraube	Altlık Shim Unterlage	Altlık Vidası Shim Screw Schraube für Unterlage	Tork Anahtar Torx Key Torx-Schlüssel
S10K SD-CR/L 07	●	●	10	9	125	07	≥14	DC.T 0702..	4008-M2.5x6	-	-	80-T08
S12K SD-CR/L 07	●	●	12	11	125	09	≥16					
S16P SD-CR/L 07	●	●	16	14.8	170	11	≥20					
S20R SD-CR/L 07	●	○	20	18.3	200	13	≥25					
S16P SD-CR/L 11	●	●	16	14.8	170	14	≥22	DC.T 11T3..	4015-M3.5x11	-	-	80-T15
S20R SD-CR/L 11	●	●	20	18.3	200	15	≥25					
S25S SD-CR/L 11	●	●	25	23	250	18	≥32					
S32T SD-CR/L 11	●	●	32	30	300	22	≥40					
S40U SD-CR/L 11	●	●	40	37.5	350	27	≥50					

R: Sağ / Right / Rechts L: Sol/Left/Links

● Stokta / In Stock / Auf Lager ○ Stokta Yok / Non Stock Item / Kein Lagerartikel, Lieferzeit auf Anfrage

Sipariş Örneği/Ordering Example/Bestellbeispiel  
1 ad./pcs./stück S08H SCFCR 06

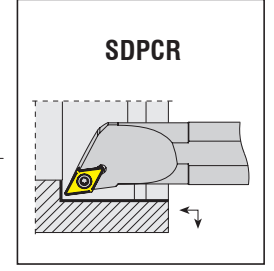
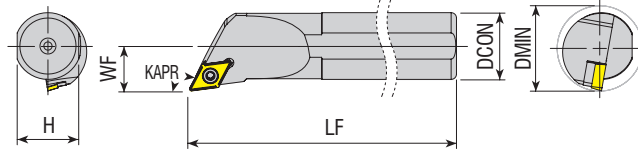

Takım Kodu Ordering Code Bestell-Bezeichnung	Stok Stock Lager		Takım Ölçüleri (mm) Dimension (mm) Abmessung (mm)					Kesici Uç Insert Wendeschneidplatte	Yedek Parçaları / Spare Parts / Ersatzteile				
	R	L	DCON	H	LF	WF	DMIN		Sıkma Vidası Screw Schraube	Altlık Shim Unterlage	Altlık Vidası Shim Screw Schraube für Unterlage	Tork Anahtar Torx Key Torx-Schlüssel	
S10K SDPCR/L 07	●	●	10	09	125	07	≥13	DC.T 0702..	4008-M2.5x6	-	-	80-T08	
S12K SDPCR/L 07	●	●	12	11	125	09	≥16						
S16P SDPCR/L 11	●	●	16	14.8	170	11	≥20	DC.T 11T3..	4015-M3.5x9	-	-	80-T15	
S20R SDPCR/L 11	●	●	20	18.3	200	13	≥25		4015-M3.5x11				
S25S SDPCR/L 11	●	●	25	23	250	17	≥32		4015-M3.5x12	AADN-2-0001	AAV-08-M3.5x8		

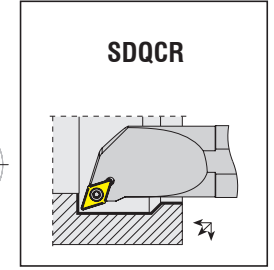
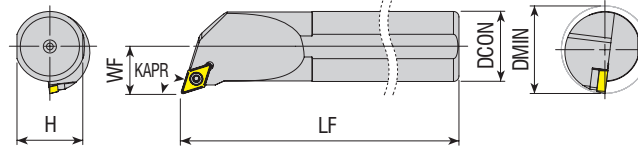

Takım Kodu Ordering Code Bestell-Bezeichnung	Stok Stock Lager		Takım Ölçüleri (mm) Dimension (mm) Abmessung (mm)					Kesici Uç Insert Wendeschneidplatte	Yedek Parçaları / Spare Parts / Ersatzteile				
	R	L	DCON	H	LF	WF	DMIN		Sıkma Vidası Screw Schraube	Altlık Shim Unterlage	Altlık Vidası Shim Screw Schraube für Unterlage	Tork Anahtar Torx Key Torx-Schlüssel	
S10K SDQCR/L 07	●	●	10	09	125	07	≥13	DC.T 0702..	4008-M2.5x6	-	-	80-T08	
S12K SDQCR/L 07	●	●	12	11	125	09	≥16						
S16P SDQCR/L 07	●	●	16	14.8	170	11	≥20	DC.T 11T3..	4015-M3.5x9	-	-	80-T15	
S20R SDQCR/L 07	●	●	20	18.3	200	13	≥25		4015-M3.5x11				
S16P SDQCR/L 11	●	●	16	14.8	170	11	≥20		4015-M3.5x12	AADN-2-0001	AAV-08-M3.5x8		
S20R SDQCR/L 11	●	●	20	18.3	200	13	≥25	4015-M3.5x14		AAV-06-M3.5x11			
S25S SDQCR/L 11	●	●	25	23	250	17	≥32						
S32T SDQCR/L 11	●	●	32	30	300	22	≥40						
S40U SDQCR/L 11	●	●	40	37.5	350	27	≥50						
A10H SDQCR/L 07	●	●	10	09	100	07	≥13	DC.T 0702..	4008-M2.5x6	-	-	80-T08	
A12H SDQCR/L 07	●	●	12	11	100	09	≥16						
A16M SDQCR/L 07	●	●	16	14.8	150	11	≥20	DC.T 11T3..	4015-M3.5x9	-	-	80-T15	
A20P SDQCR/L 07	●	●	20	18.3	170	13	≥25		4015-M3.5x11				
A16M SDQCR/L 11	●	●	16	14.8	150	11	≥20		4015-M3.5x12	AADN-2-0001	AAV-08-M3.5x8		
A20P SDQCR/L 11	●	●	20	18.3	170	13	≥25	4015-M3.5x14		AAV-06-M3.5x11			
A25R SDQCR/L 11	●	●	25	23	200	17	≥32						
A32S SDQCR/L 11	●	●	32	30	250	22	≥40						

R: Sağ / Right / Rechts L: Sol/Left/Links

● Stokta / In Stock / Auf Lager ○ Stokta Yok / Non Stock Item / Kein Lagerartikel, Lieferzeit auf Anfrage

Sipariş Örneği/Ordering Example/Bestellbeispiel

1 ad./pcs./stück S10K SDPCR 07

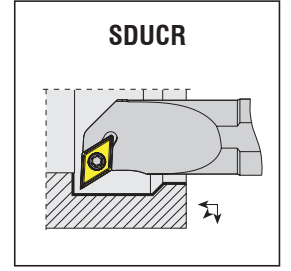
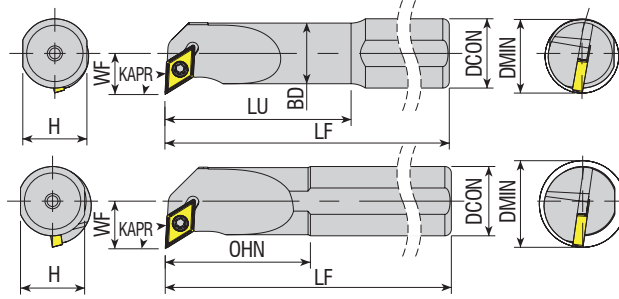

**Takım Kodu**  
**Ordering Code**  
**Bestell-Bezeichnung**

Stok Stock Lager	Takım Ölçüleri (mm) Dimension (mm) Abmessung (mm)								Kesici Uç Insert Wendeschneidplatte	Yedek Parçaları / Spare Parts / Ersatzteile				
	R	L	DCON	BD	H	LU=OHN	LF	WF		DMIN	Sıkma Vidası Screw Schraube	Altlık Shim Unterlage	Altlık Vidası Shim Screw Schraube für Unterlage	Tork Anahtar Torx Key Torx-Schlüssel
	●	●	10	8	09	30	125	08	≥13	DC.T 0702..	4008-M2.5x6	-	-	80-T08
S0810K SDUCR/L 07	●	●	10	10	09	25	125	08	≥13					
S10K SDUCR/L 07	●	●	12	12	11	25	125	09	≥16					
S12K SDUCR/L 07	●	●	16	11.5	14.8	37	170	09	≥16					
S1216P SDUCR/L 07	●	●	16	14	14.8	45	170	9.5	≥17					
S1416P SDUCR/L 07	●	●	16	16	14.8	35	170	11	≥20					
S16P SDUCR/L 07	●	●	20	20	18.3	40	200	13	≥25					
S20R SDUCR/L 07	●	●	16	14	14.8	45	170	11	≥18	DC.T 11T3..	4015-M3.5x9	-	-	80-T15
S1416P SDUCR/L 11	●	●	16	16	14.8	35	170	11	≥20					
S1620R SDUCR/L 11	●	●	20	16	18.3	50	200	11	≥20					
S20R SDUCR/L 11	●	●	20	20	18.3	40	200	13	≥25					
S25S SDUCR/L 11	●	●	25	25	23	50	250	17	≥32					
S32T SDUCR/L 11	●	●	32	32	30	60	300	22	≥40					
S40U SDUCR/L 11	●	●	40	40	37.5	70	350	27	≥50					
S50V SDUCR/L 11	●	●	50	50	47	80	400	35	≥63					
A0810H SDUCR/L 07	●	●	10	8	09	30	100	08	≥13	DC.T 0702..	4008-M2.5x6	-	-	80-T08
A10H SDUCR/L 07	●	●	10	10	09	25	100	08	≥13					
A12H SDUCR/L 07	●	●	12	12	11	25	100	09	≥16					
A16M SDUCR/L 07	●	●	16	16	14.8	35	150	11	≥20					
A20P SDUCR/L 07	●	●	20	20	18.3	40	170	13	≥25					
A16M SDUCR/L 11	●	●	16	16	14.8	35	150	11	≥20	DC.T 11T3..	4015-M3.5x9	-	-	80-T15
A20P SDUCR/L 11	●	●	20	20	18.3	40	170	13	≥25					
A25R SDUCR/L 11	●	●	25	25	23	50	200	17	≥32					
A32S SDUCR/L 11	●	●	32	32	30	60	250	22	≥40					

R: Sağ / Right / Rechts L: Sol/Left/Links

● Stokta / In Stock / Auf Lager ○ Stokta Yok / Non Stock Item / Kein Lagerartikel, Lieferzeit auf Anfrage

Sipariş Örneği/Ordering Example/Bestellbeispiel

1 ad./pcs./stück S0810K SDUCR 07

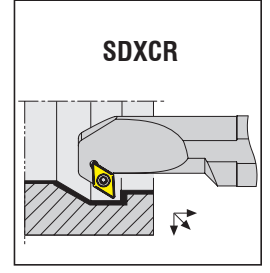
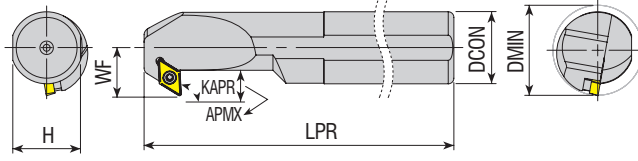

Takım Kodu Ordering Code Bestell-Bezeichnung	Stok Stock Lager		Takım Ölçüleri (mm) Dimension (mm) Abmessung (mm)					Kesici Uç Insert Wendeschneidplatte	Yedek Parçaları / Spare Parts / Ersatzteile				
	R	L	DCON	H	LPR	WF	APMX		DMIN	Sıkma Vidası Screw Schraube	Altık Shim Unterlage	Altık Vidası Shim Screw Schraube für Unterlage	Tork Anahtar Torx Key Torx-Schlüssel
S12K SDXCR/L 07	●	●	12	11	125	09	4.5	≥16	DC.T 0702..	4008-M2.5x6	-	-	80-T08
S16P SDXCR/L 07	●	●	16	14.8	170	11	6.5	≥20					
S20R SDXCR/L 07	●	●	20	18.3	200	13	6.5	≥25					
S16P SDXCR/L 11	●	●	16	14.8	170	11	6.5	≥20	DC.T 11T3..	4015-M3.5x11	-	-	80-T15
S20R SDXCR/L 11	●	●	20	18.3	200	14	7.5	≥25					
S25S SDXCR/L 11	●	●	25	23	250	17	9	≥32					
S32T SDXCR/L 11	●	●	32	30	300	22	12.5	≥40	DC.T 11T3..	4015-M3.5x14	AADN-2-0001	AAV-06-M3.5x11	80-T15
S40U SDXCR/L 11	●	●	40	37.5	350	27	14.5	≥50					
A12H SDXCR/L 07	●	●	12	11	100	09	4.5	≥16					
A16M SDXCR/L 07	●	●	16	14.8	150	11	6.5	≥20	DC.T 0702..	4008-M2.5x6	-	-	80-T08
A20P SDXCR/L 07	●	●	20	18.3	170	13	6.5	≥25					
A16M SDXCR/L 11	●	●	16	14.8	150	11	7.5	≥20					
A20P SDXCR/L 11	●	●	20	18.3	170	14	7.5	≥25	DC.T 11T3..	4015-M3.5x11	-	-	80-T15
A25R SDXCR/L 11	●	●	25	23	200	17	9	≥32					
A32S SDXCR/L 11	●	●	32	30	250	22	12.5	≥40					

R: Sağ / Right / Rechts L: Sol/Left/Links  
● Stokta / In Stock / Auf Lager ○ Stokta Yok / Non Stock Item / Kein Lagerartikel, Lieferzeit auf Anfrage  
Not: "APMX" ölçüleri R0.4'e göre verilmiştir.  
Note: Dimensions of "APMX" are given according to R.0,4  
Hinweis: Das Maß "APMX" bezieht sich auf R 0,4

Sipariş Örneği/Ordering Example/Bestellbeispiel  
1 ad./pcs./stück S12K SDXCR 07

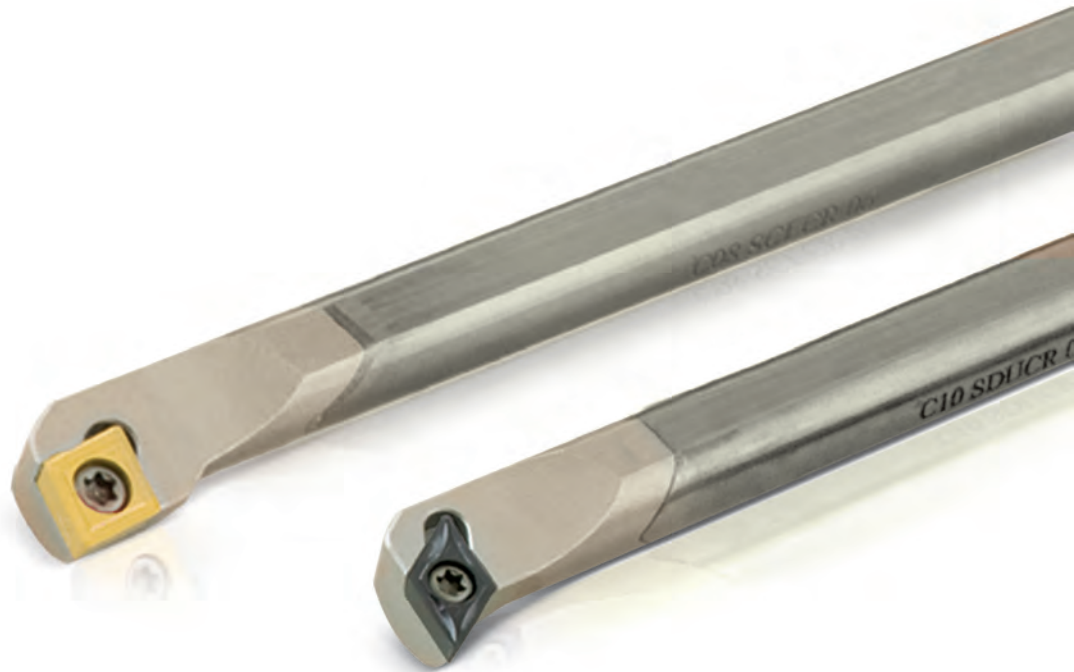



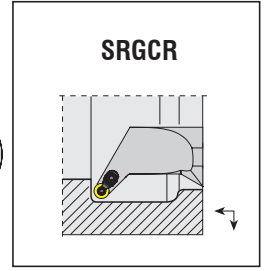
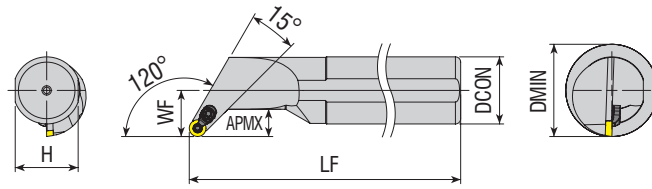

**Takım Kodu**  
**Ordering Code**  
*Bestell-Bezeichnung*

Stok Stock Lager	Takım Ölçüleri (mm) Dimension (mm) Abmessung (mm)							Kesici Uç Insert Wendeschneidplatte	Yedek Parçaları / Spare Parts / Ersatzteile						
	R	L	DCON	H	LF	WF	APMX		DMIN	Sıkma Vidası Screw Schraube	Altlık Shim Unterlage	Altlık Vidası Shim Screw Schraube für Unterlage	Baskı Pabuçu Shim Screw Spann Pratze	Pabuç Vidası Shim Screw Klemmschraube	Anahtar Allen Key Innensechskantschlüssel
S16P SRGCR/L 08	●	○	16	14.8	170	11	7	≥22	RCM. 0803..	3008-M3x8	-	-	ACK-15	4015-M3.5x11	80-T08
S20R SRGCR/L 08	●	●	20	18.3	200	13	7	≥26							
S25S SRGCR/L 08C	●	●	25	23	250	17	9.5	≥34							
S32T SRGCR/L 08C	●	○	32	30	300	22	13	≥44							
S40U SRGCR/L 08C	●	○	40	37.5	350	27	15	≥54							
A16M SRGCR/L 08	●	●	16	14.8	150	11	7	≥22							
A20P SRGCR/L 08	●	●	20	18.3	170	13	7	≥26							
A25R SRGCR/L 08C	●	●	25	23	200	17	9.5	≥34							
A32S SRGCR/L 08C	●	●	32	30	250	22	13	≥44							
A40T SRGCR/L 08C	●	●	40	37.5	300	27	15	≥54							

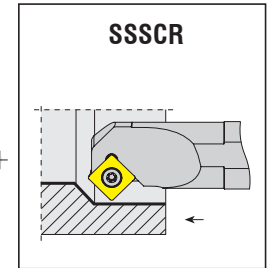
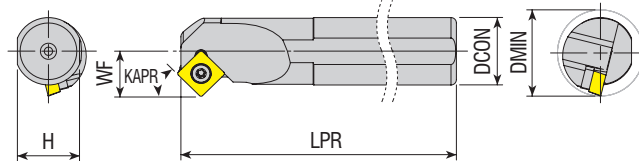

**Takım Kodu**  
**Ordering Code**  
*Bestell-Bezeichnung*

Stok Stock Lager	Takım Ölçüleri (mm) Dimension (mm) Abmessung (mm)							Kesici Uç Insert Wendeschneidplatte	Yedek Parçaları / Spare Parts / Ersatzteile			
	R	L	DCON	H	LPR	WF	DMIN		Sıkma Vidası Screw Schraube	Altlık Shim Unterlage	Altlık Vidası Shim Screw Schraube für Unterlage	Tork Anahtar Torx Key Torx-Schlüssel
S16P SSSCR/L 09	●	●	16	14.8	170	11	≥20	SC.T 09T3..	4015-M3.5x9	-	-	80-T15
S20R SSSCR/L 09	●	●	20	18.3	200	13	≥25					
S25S SSSCR/L 09	●	●	25	23	250	17	≥32					
S25S SSSCR/L 12	●	●	25	23	250	17	≥32	SC.T 1204..	4020-M4.5x12	AASN-2-0001	AAV-08-M3.5x8	80-T20
S32T SSSCR/L 12	●	○	32	30	300	22	≥40					
S40U SSSCR/L 12	●	○	40	37.5	350	27	≥50					

R: Sağ / Right / Rechts L: Sol/Left/Links

● Stokta / In Stock / Auf Lager ○ Stokta Yok / Non Stock Item / Kein Lagerartikel, Lieferzeit auf Anfrage

Sipariş Örneği/Ordering Example/Bestellbeispiel

1 ad./pcs./stück S16P SRGCR 08

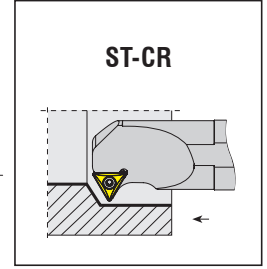
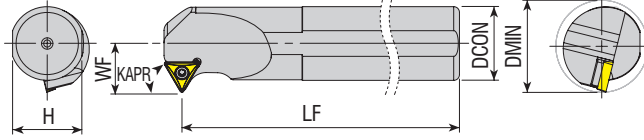

ST-CR

Takım Kodu Ordering Code Bestell-Bezeichnung	Stok Stock Lager		Takım Ölçüleri (mm) Dimension (mm) Abmessung (mm)				Kesici Uç Insert Wendeschneidplatte	Yedek Parçaları / Spare Parts / Ersatzteile				
	R	L	DCON	H	LF	WF		DMIN	Sıkma Vidası Screw Schraube	Altlık Shim Unterlage	Altlık Vidası Shim Screw Schraube für Unterlage	Tork Anahtar Torx Key Torx-Schlüssel
S12K ST-CR/L 11	●	●	12	11	125	09	≥17	TC.T 1102..	4008-M2.5x6	-	-	80-T08
S16P ST-CR/L 11	●	○	16	14.8	170	11	≥20					
S20R ST-CR/L 11	●	○	20	18.3	200	13	≥25					
S16P ST-CR/L 16	●	●	16	14.8	170	11	≥20	TC.T 16T3..	4015-M3.5x9	-	-	80-T15
S20R ST-CR/L 16	●	●	20	18.3	200	13	≥25		4015-M3.5x11			
S25S ST-CR/L 16	●	●	25	23	250	17	≥32		4015-M3.5x14			
S32T ST-CR/L 16	●	●	32	30	300	22	≥40	AAV-06-M3.5x11				
S40U ST-CR/L 16	●	●	40	37.5	350	27	≥50					

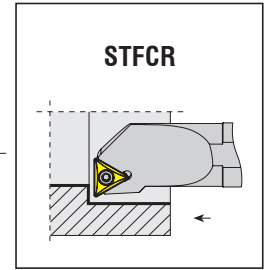
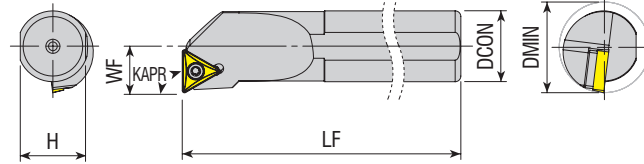

STFCR

Takım Kodu Ordering Code Bestell-Bezeichnung	Stok Stock Lager		Takım Ölçüleri (mm) Dimension (mm) Abmessung (mm)				Kesici Uç Insert Wendeschneidplatte	Yedek Parçaları / Spare Parts / Ersatzteile				
	R	L	DCON	H	LF	WF		DMIN	Sıkma Vidası Screw Schraube	Altlık Shim Unterlage	Altlık Vidası Shim Screw Schraube für Unterlage	Tork Anahtar Torx Key Torx-Schlüssel
S0610F STF-CR/L 06	●	●	10	09	80	4.5	≥08	TC.T 06T1..	3006-M2x4	-	-	80-T06
S08H STF-CR/L 06	●	●	08	7.3	100	06	≥11					
S10K STF-CR/L 09	●	●	10	09	125	07	≥13	TC.T 0902..	3007-M2.2x5	-	-	80-T07
S12K STF-CR/L 09	●	●	12	11	125	09	≥17					
S12K STF-CR/L 11	●	●	12	11	125	09	≥17	TC.T 1102..	4008-M2.5x6	-	-	80-T08
S16P STF-CR/L 11	●	●	16	14.8	170	11	≥20					
S20R STF-CR/L 11	●	●	20	18.3	200	13	≥25					
S16P STF-CR/L 16	●	●	16	14.8	170	11	≥20	TC.T 16T3..	4015-M3.5x9	-	-	80-T15
S20R STF-CR/L 16	●	●	20	18.3	200	13	≥25		4015-M3.5x11			
S25S STF-CR/L 16	●	●	25	23	250	17	≥32		4015-M3.5x14			
S32T STF-CR/L 16	●	●	32	30	300	22	≥40	AAV-06-M3.5x11				
S40U STF-CR/L 16	●	○	40	37.5	350	27	≥50					
A10H STF-CR/L 11	●	●	10	09	100	07	≥13	TC.T 1102..	4008-M2.5x6	-	-	80-T08
A12H STF-CR/L 11	●	●	12	11	100	09	≥17					
A16M STF-CR/L 11	●	●	16	14.8	150	11	≥20					

R: Sağ / Right / Rechts L: Sol/Left/Links

● Stokta / In Stock / Auf Lager ○ Stokta Yok / Non Stock Item / Kein Lagerartikel, Lieferzeit auf Anfrage

Sipariş Örneği/Ordering Example/Bestellbeispiel

1 ad./pcs./stück S12K ST-CR 11

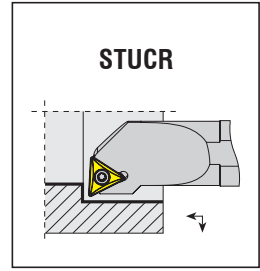
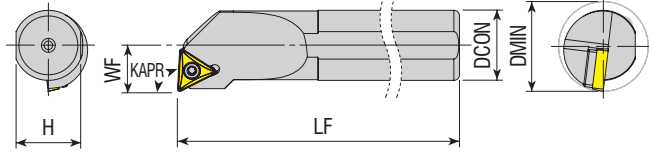

Takım Kodu Ordering Code Bestell-Bezeichnung	Stok Stock Lager		Takım Ölçüleri (mm) Dimension (mm) Abmessung (mm)				Kesici Uç Insert Wendeschneidplatte	Yedek Parçaları / Spare Parts / Ersatzteile				
	R	L	DCON	H	LF	WF		DMIN	Sıkma Vidası Screw Schraube	Altlık Shim Unterlage	Altlık Vidası Shim Screw Schraube für Unterlage	Tork Anahtar Torx Key Torx-Schlüssel
S10K STUCR/L 09	●	●	10	09	125	07	≥13	TC.T 0902..	3007-M2.2x5			80-T07
S12K STUCR/L 09	●	●	12	11	125	09	≥16					
S12K STUCR/L 11	●	●	12	11	125	09	≥17	TC.T 1102..	4008-M2.5x6	-	-	80-T08
S16P STUCR/L 11	●	●	16	14.8	170	11	≥20					
S20R STUCR/L 11	●	●	20	18.3	200	13	≥25	TC.T 16T3..	4015-M3.5x9 4015-M3.5x11	-	-	80-T15
S16P STUCR/L 16	●	●	16	14.8	170	11	≥20					
S20R STUCR/L 16	●	●	20	18.3	200	13	≥25	TC.T 16T3..	4015-M3.5x14	AATN-2-0001	AAV-08-M3.5x8 AAV-06-M3.5x11	80-T15
S25S STUCR/L 16	●	●	25	23	250	17	≥32					
S32T STUCR/L 16	●	●	32	30	300	22	≥40	TC.T 0902..	3007-M2.2x5			80-T07
S40U STUCR/L 16	●	●	40	37.5	350	27	≥50					
A10H STUCR/L 09	●	●	10	09	100	07	≥13	TC.T 0902..	3007-M2.2x5			80-T07
A12H STUCR/L 09	●	●	12	11	100	09	≥16					
A12H STUCR/L 11	●	●	12	11	100	09	≥16	TC.T 1102..	4008-M2.5x6	-	-	80-T08
A16M STUCR/L 11	●	●	16	14.8	150	11	≥20					
A20P STUCR/L 11	●	●	20	18.3	170	13	≥25	TC.T 16T3..	4015-M3.5x9 4015-M3.5x11	-	-	80-T15
A16M STUCR/L 16	●	●	16	14.8	150	11	≥20					
A20P STUCR/L 16	●	●	20	18.3	170	13	≥25	TC.T 16T3..	4015-M3.5x14	AATN-2-0001	AAV-08-M3.5x8 AAV-06-M3.5x11	80-T15
A25R STUCR/L 16	●	●	25	23	200	17	≥32					
A32S STUCR/L 16	●	●	32	30	250	22	≥40					

R: Sağ / Right / Rechts L: Sol/Left/Links

● Stokta / In Stock / Auf Lager ○ Stokta Yok / Non Stock Item / Kein Lagerartikel, Lieferzeit auf Anfrage

Sipariş Örneği/Ordering Example/Bestellbeispiel

1 ad./pcs./stück S10K STUCR 09



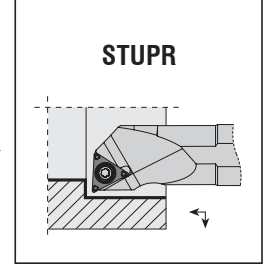
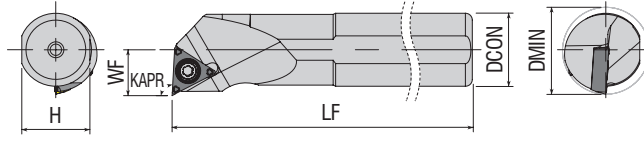

Takım Kodu Ordering Code Bestell-Bezeichnung	Stok Stock Lager		Takım Ölçüleri (mm) Dimension (mm) Abmessung (mm)				Kesici Uç Insert Wendeschneidplatte	Yedek Parçaları / Spare Parts / Ersatzteile				
	R	L	DCON	H	LF	WF		DMIN	Sıkma Vidası Screw Schraube	Altlık Shim Unterlage	Altlık Vidası Shim Screw Schraube für Unterlage	Tork Anahtar Torx Key Torx-Schlüssel
S08H STUPR/L 0802	●	○	08	7.3	100	05	≥10	TP. 0802..	3006-M2x4			80-T06
S10K STUPR/L 1103	●	○	10	09	125	06	≥12		TP. 1103..	4010-M3x6		
S12K STUPR/L 1103	●	●	12	11	125	09	≥16					
S12M STUPR/L 1103	●	●	12	11	150	08	≥16					
S16P STUPR/L 1103	●	●	16	14.8	170	10	≥20					
S16R STUPR/L 1103	●	●	16	14.8	200	10	≥20		4010-M3x8			
A20R STUPR/L 1103	●	○	20	18.3	200	13	≥25					

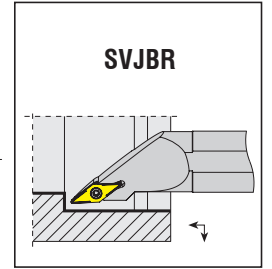
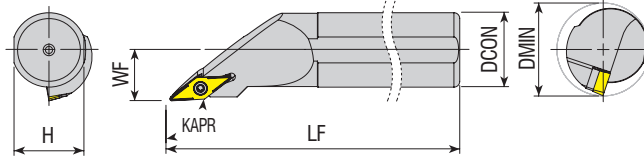

Takım Kodu Ordering Code Bestell-Bezeichnung	Stok Stock Lager		Takım Ölçüleri (mm) Dimension (mm) Abmessung (mm)				Kesici Uç Insert Wendeschneidplatte	Yedek Parçaları / Spare Parts / Ersatzteile				
	R	L	DCON	H	LF	WF		DMIN	Sıkma Vidası Screw Schraube	Altlık Shim Unterlage	Altlık Vidası Shim Screw Schraube für Unterlage	Tork Anahtar Torx Key Torx-Schlüssel
S25S SVJBR/L 16	●	●	25	23	250	17	≥32	VB.T 1604..	4015-M3.5x12	AAVN-2-0002	AAV-08-M3.5x8	80-T15
S32T SVJBR/L 16	●	●	32	30	300	22	≥40		4015-M3.5x14		AAV-06-M3.5x11	
S40U SVJBR/L 16	●	●	40	37.5	350	27	≥50					

R: Sağ / Right / Rechts L: Sol/Left/Links  
● Stokta / In Stock / Auf Lager ○ Stokta Yok / Non Stock Item / Kein Lagerartikel, Lieferzeit auf Anfrage

Sipariş Örneği/Ordering Example/Bestellbeispiel  
1 ad./pcs./stück S08H STUPR 0802



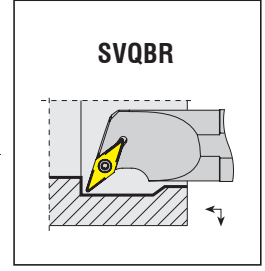
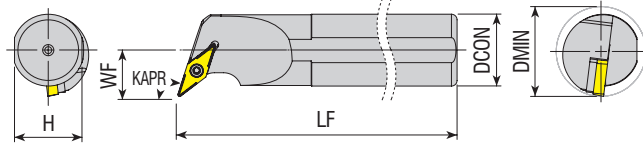

Takım Kodu Ordering Code Bestell-Bezeichnung	Stok Stock Lager		Takım Ölçüleri (mm) Dimension (mm) Abmessung (mm)				Kesici Uç Insert Wendeschneidplatte	Yedek Parçaları / Spare Parts / Ersatzteile				
	R	L	DCON	H	LF	WF		DMIN	Sıkma Vidası Screw Schraube	Altık Shim Unterlage	Altık Vidası Shim Screw Schraube für Unterlage	Tork Anahtar Torx Key Torx-Schlüssel
S16P SVQBR/L 11	●	●	16	14.8	170	11	≥20	VB.T 1103..	4008-M2.5x6	-	-	80-T08
S20R SVQBR/L 11	●	●	20	18.3	200	13	≥25					
S25S SVQBR/L 16	●	●	25	23	250	17	≥32	VB.T 1604..	4015-M3.5x14	AAVN-2-0002	AAV-08-M3.5x8	80-T15
S32T SVQBR/L 16	●	●	32	30	300	22	≥40				AAV-06-M3.5x11	
S40U SVQBR/L 16	●	●	40	37.5	350	27	≥50					
A20Q SVQBR/L 11	●	●	20	18.5	180	13	≥25	VB.T 1103..	4008-M2.5x6	-	-	80-T08
A20Q SVQBR/L 16	●	●	20	18.5	180	20	≥30	VB.T 1604..	4015-M3.5x11	-	-	80-T15
A25S SVQBR/L 16	●	●	25	23	250	17	≥32		4015-M3.5x14	AAVN-2-0002	AAV-06-M3.5x11	
A32S SVQBR/L 16	●	●	32	30	250	22	≥40					

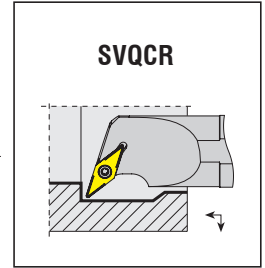
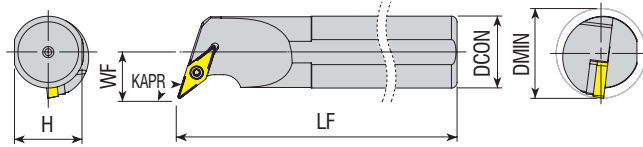

Takım Kodu Ordering Code Bestell-Bezeichnung	Stok Stock Lager		Takım Ölçüleri (mm) Dimension (mm) Abmessung (mm)				Kesici Uç Insert Wendeschneidplatte	Yedek Parçaları / Spare Parts / Ersatzteile				
	R	L	DCON	H	LF	WF		DMIN	Sıkma Vidası Screw Schraube	Altık Shim Unterlage	Altık Vidası Shim Screw Schraube für Unterlage	Tork Anahtar Torx Key Torx-Schlüssel
S16P SVQCR/L 11	●	●	16	14.8	170	11	≥20	VC.T 1103..	4008-M2.5x6	-	-	80-T08
S20R SVQCR/L 11	●	●	20	18.3	200	13	≥25					
S25S SVQCR/L 16	●	●	25	23	250	17	≥32	VC.T 1604..	4015-M3.5x14	AAVN-2-0002	AAV-08-M3.5x8	80-T15
S32T SVQCR/L 16	●	●	32	30	300	22	≥40				AAV-06-M3.5x11	
S40U SVQCR/L 16	●	●	40	37.5	350	27	≥50					
A16M SVQCR/L 11	●	●	16	14.8	150	11	≥20	VC.T 1103..	4008-M2.5x6	-	-	80-T08
A20P SVQCR/L 11	●	●	20	18.3	170	13	≥25	VC.T 1604..	4015-M3.5x14	AAVN-2-0002	AAV-08-M3.5x8	80-T15
A25R SVQCR/L 16	●	●	25	23	200	17	≥32				AAV-06-M3.5x11	
A32S SVQCR/L 16	●	●	32	30	250	22	≥40					
A40T SVQCR/L 16	●	●	40	37.5	300	27	≥50					

R: Sağ / Right / Rechts L: Sol/Left/Links

● Stokta / In Stock / Auf Lager ○ Stokta Yok / Non Stock Item / Kein Lagerartikel, Lieferzeit auf Anfrage

Sipariş Örneği/Ordering Example/Bestellbeispiel

1 ad./pcs./stück S16P SVQBR 11

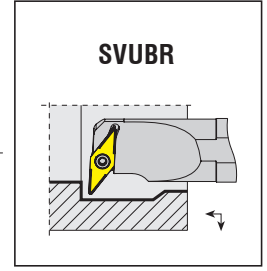
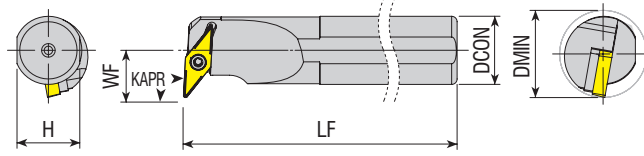

Takım Kodu Ordering Code Bestell-Bezeichnung	Stok Stock Lager		Takım Ölçüleri (mm) Dimension (mm) Abmessung (mm)					Kesici Uç Insert Wendeschneidplatte	Yedek Parçaları / Spare Parts / Ersatzteile				
	R	L	DCON	H	LF	WF	DMIN		Sıkma Vidası Screw Schraube	Altlık Shim Unterlage	Altlık Vidası Shim Screw Schraube für Unterlage	Tork Anahtar Torx Key Torx-Schlüssel	
S16P SVUBR/L 11	●	●	16	14.8	170	12.5	≥20	VB.T 1103..	4008-M2.5x6	-	-	80-T08	
S20R SVUBR/L 11	●	●	20	18.3	200	13	≥25						
S25S SVUBR/L 16	●	●	25	23	250	19	≥32	VB.T 1604..	4015-M3.5x14	AAVN-2-0002	AAV-06-M3.5x11	80-T15	
S32T SVUBR/L 16	●	●	32	30	300	22	≥40						
S40U SVUBR/L 16	●	●	40	37.5	350	27	≥50						
A20Q SVUBR/L 16	●	○	20	18.3	180	20	≥30						
A32S SVUBR/L 16	●	●	32	30	250	22	≥40	4015-M3.5x14	-	-	4015-M3.5x14	AAVN-2-0002	AAV-06-M3.5x11

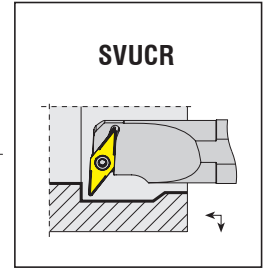
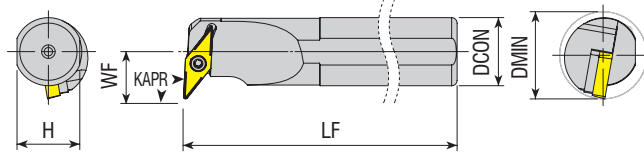

Takım Kodu Ordering Code Bestell-Bezeichnung	Stok Stock Lager		Takım Ölçüleri (mm) Dimension (mm) Abmessung (mm)					Kesici Uç Insert Wendeschneidplatte	Yedek Parçaları / Spare Parts / Ersatzteile			
	R	L	DCON	H	LF	WF	DMIN		Sıkma Vidası Screw Schraube	Altlık Shim Unterlage	Altlık Vidası Shim Screw Schraube für Unterlage	Tork Anahtar Torx Key Torx-Schlüssel
S16P SVUCR/L 11	●	●	16	14.8	170	12.5	≥20	VC.T 1103..	4008-M2.5x6	-	-	80-T08
S20R SVUCR/L 11	●	●	20	18.3	200	13	≥25					
S25S SVUCR/L 16	●	●	25	23	250	19	≥32	VC.T 1604..	4015-M3.5x14	AAVN-2-0002	AAV-06-M3.5x11	80-T15
S32T SVUCR/L 16	●	●	32	30	300	22	≥40					
S40U SVUCR/L 16	●	●	40	37.5	350	27	≥50					
A12K SVUCR/L 07	●	●	12	11	125	9	≥16					
A20P SVUCR/L 11	●	○	20	18.3	170	13	≥25	VC.T 1103..	4008-M2.5x6	-	-	80-T08
A20Q SVUCR/L 11	●	●	20	18.3	180	13	≥25	VC.T 1103..	4008-M2.5x6	-	-	80-T08
A25R SVUCR/L 16	●	●	25	23	200	19	≥32	VC.T 1604..	4015-M3.5x14	AAVN-2-0002	AAV-06-M3.5x11	80-T15

R: Sağ / Right / Rechts L: Sol/Left/Links  
● Stokta / In Stock / Auf Lager ○ Stokta Yok / Non Stock Item / Kein Lagerartikel, Lieferzeit auf Anfrage

Sipariş Örneği/Ordering Example/Bestellbeispiel  
1 ad./pcs./stück S16P SVUBR 11

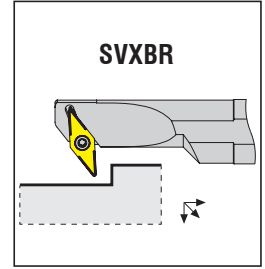
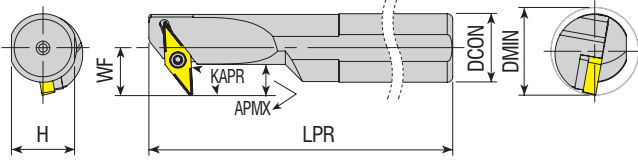

Takım Kodu Ordering Code Bestell-Bezeichnung	Stok Stock Lager		Takım Ölçüleri (mm) Dimension (mm) Abmessung (mm)					Kesici Uç Insert Wendeschneidplatte	Yedek Parçaları / Spare Parts / Ersatzteile				
	R	L	DCON	H	LPR	WF	APMX		DMIN	Sıkma Vidası Screw Schraube	Altılık Shim Unterlage	Altılık Vidası Shim Screw Schraube für Unterlage	Tork Anahtar Torx Key Torx-Schlüssel
<b>S16P SVXBR/L 1102</b>	●	○	16	14.8	170	12.5	7.2	≥20	VBM. 1102..	4008-M2.5x6	-	-	80-T08
<b>S20R SVXBR/L 1102</b>	●	●	20	18.3	200	13	5.7	≥25					
<b>S16P SVXBR/L 11</b>	●	●	16	14.8	170	12.5	7.2	≥20	VB.T 1103..				
<b>S20R SVXBR/L 11</b>	●	●	20	18.3	200	13	5.7	≥25					
<b>S25S SVXBR/L 16</b>	●	●	25	23	250	19	10.2	≥32	VB.T 1604..	4015-M3.5x14	AAVN-2-0002	AAV-06-M3.5x11	80-T15
<b>S32T SVXBR/L 16</b>	●	●	32	30	300	22	11.7	≥40					
<b>S40U SVXBR/L 16</b>	●	●	40	37.5	350	27	14.3	≥50					

Not: "APMX" ölçüleri R0.4'e göre verilmiştir.  
Note: Dimensions of "APMX" are given according to R0.4  
Hinweis: Das Maß "APMX" bezieht sich auf R0.4

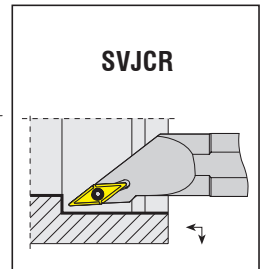
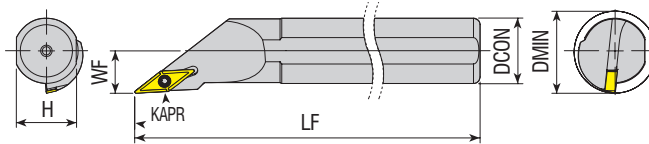

Takım Kodu Ordering Code Bestell-Bezeichnung	Stok Stock Lager		Takım Ölçüleri (mm) Dimension (mm) Abmessung (mm)					Kesici Uç Insert Wendeschneidplatte	Yedek Parçaları / Spare Parts / Ersatzteile			
	R	L	DCON	H	LF	WF	DMIN		Sıkma Vidası Screw Schraube	Altılık Shim Unterlage	Altılık Vidası Shim Screw Schraube für Unterlage	Tork Anahtar Torx Key Torx-Schlüssel
<b>S12K SVJCR/L 11</b>	●	●	12	11	125	7	≥13	VC.T 1103..	4008-M2.5x6	-	-	80-T08
<b>S16P SVJCR/L 11</b>	●	●	16	14.8	170	11	≥20					
<b>S20R SVJCR/L 11</b>	●	●	20	18.3	200	13	≥25					
<b>A12H SVJCR/L 11</b>	●	●	12	11	100	07	≥13					
<b>A16M SVJCR/L 11</b>	●	●	16	14.8	150	11	≥20					
<b>A20P SVJCR/L 11</b>	●	●	20	18.3	170	13	≥25					

R: Sağ / Right / Rechts L: Sol/Left/Links  
● Stokta / In Stock / Auf Lager ○ Stokta Yok / Non Stock Item / Kein Lagerartikel, Lieferzeit auf Anfrage

Sipariş Örneği/Ordering Example/Bestellbeispiel  
1 ad./pcs./stück S16P SVXBR 1102

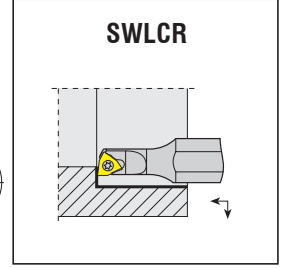
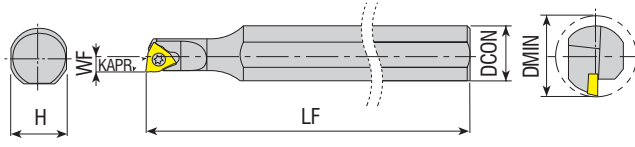

Takım Kodu Ordering Code Bestell-Bezeichnung	Stok Stock Lager	Takım Ölçüleri (mm) Dimension (mm) Abmessung (mm)						Kesici Uç Insert Wendeschneidplatte	Yedek Parçaları / Spare Parts / Ersatzteile			
		DCON	H	LF	WF	DMIN	Sıkma Vidası Screw Schraube		Altlık Shim Unterlage	Altlık Vidası Shim Screw Schraube für Unterlage	Tork Anahtar Torx Key Torx-Schlüssel	
S0608H SWLCR 03	●	08	7.3	100	04	≥08	WC.. 0302..		4008-M2.5x4	-	-	80-T08
S0810K SWLCR 03	●	10	09	125	06	≥10						

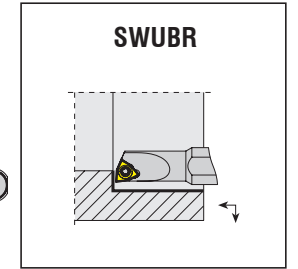
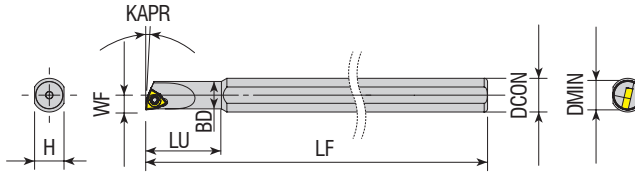

Takım Kodu Ordering Code Bestell-Bezeichnung	Stok Stock Lager	Takım Ölçüleri (mm) Dimension (mm) Abmessung (mm)								Kesici Uç Insert Wendeschneidplatte	Yedek Parçaları / Spare Parts / Ersatzteile				
		DCON	BD	H	LU	LF	DMIN	WF	Sıkma Vidası Screw Schraube		Altlık Shim Unterlage	Altlık Vidası Shim Screw Schraube für Unterlage	Tork Anahtar Torx Key Torx-Schlüssel		
S0610H SWUBR 06	●	10	5	7.3	18	100	≥6	3	WBGT 060102-L		3006-M2x3.3	-	-	80-T06	
S08H SWUBR 06-5.5	●	08	5	7.3	18	100	≥5.7	2.75							3006-M2x4
S08H SWUBR 06-7	●	08	6.5	7.3	18	100	≥7	3.5							

R: Sağ / Right / Rechts L: Sol/Left/Links

● Stokta / In Stock / Auf Lager ○ Stokta Yok / Non Stock Item / Kein Lagerartikel, Lieferzeit auf Anfrage

KYCR-ISCR Ucuna Uygundur. / Compatible with KYCR-ISCR Insert. / Kompatibel mit KYCR-ISCR Wendeplatten.

Sipariş Örneği/Ordering Example/Bestellbeispiel

1 ad./pcs./stück S0608H SWLCR 03



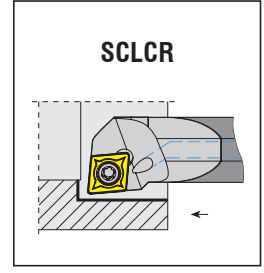
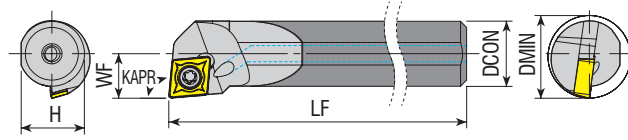

Takım Kodu Ordering Code Bestell-Bezeichnung	Stok Stock Lager		Takım Ölçüleri (mm) Dimension (mm) Abmessung (mm)					Kesici Uç Insert Wendeschneidplatte	Yedek Parçaları / Spare Parts / Ersatzteile			
	R	L	DCON	H	LF	WF	DMIN		Sıkma Vidası Screw Schraube	Altlık Shim Unterlage	Altlık Vidası Shim Screw Schraube für Unterlage	Tork Anahtar Torx Key Torx-Schlüssel
<b>C06J SCLCR/L 06</b>	●	○	6	5.7	110	4.5	≥8	<b>CC.T 0602..</b>	4008-M2.5x6	-	-	80-T08
<b>E08K SCLCR/L 06</b>	●	●	8	7.5	125	6	≥11					
<b>E10M SCLCR/L 06</b>	●	●	10	9.5	150	7	≥13					
<b>E12Q SCLCR/L 06</b>	●	●	12	11	180	9	≥16					
<b>E16R SCLCR/L 09</b>	●	●	16	15	200	11	≥20	<b>CC.T 09T3..</b>	4015-M3.5x9	-	-	80-T15
<b>E20S SCLCR/L 09</b>	●	●	20	19	250	13	≥24					

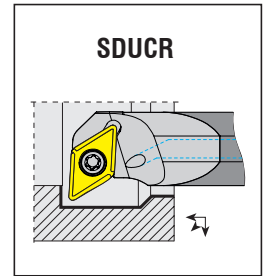
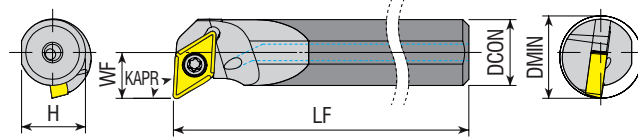

Takım Kodu Ordering Code Bestell-Bezeichnung	Stok Stock Lager		Takım Ölçüleri (mm) Dimension (mm) Abmessung (mm)					Kesici Uç Insert Wendeschneidplatte	Yedek Parçaları / Spare Parts / Ersatzteile			
	R	L	DCON	H	LF	WF	DMIN		Sıkma Vidası Screw Schraube	Altlık Shim Unterlage	Altlık Vidası Shim Screw Schraube für Unterlage	Tork Anahtar Torx Key Torx-Schlüssel
<b>E10M SDUCR/L 07</b>	●	●	10	9.5	150	8	≥13	<b>DC.T 0702..</b>	4008-M2.5x6	-	-	80-T08
<b>E12Q SDUCR/L 07</b>	●	●	12	11	180	9	≥16					
<b>E16R SDUCR/L 11</b>	●	●	16	15	200	11	≥20	<b>DC.T 11T3..</b>	4015-M3.5x9	-	-	80-T15
<b>E20S SDUCR/L 11</b>	●	●	20	18.3	250	12	≥23					

R: Sağ / Right / Rechts L: Sol/Left/Links

● Stokta / In Stock / Auf Lager ○ Stokta Yok / Non Stock Item / Kein Lagerartikel, Lieferzeit auf Anfrage

Sipariş Örneği/Ordering Example/Bestellbeispiel

1 ad./pcs./stück C06J SCLCR 06



KAPR=90°

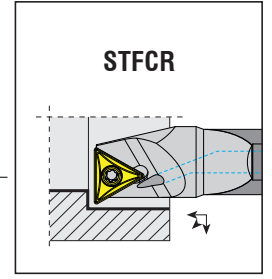
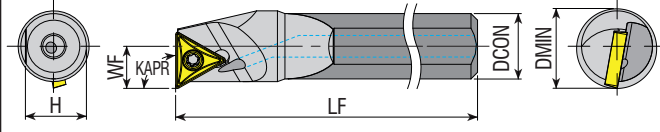

**Takım Kodu**  
**Ordering Code**  
**Bestell-Bezeichnung**

Stok Stock Lager	Takım Ölçüleri (mm) Dimension (mm) Abmessung (mm)						Kesici Uç Insert Wendeschneidplatte	Yedek Parçaları / Spare Parts / Ersatzteile				
	R	L	DCON	H	LF	WF		DMIN	Sıkma Vidası Screw Schraube	Altık Shim Unterlage	Altık Vidası Shim Screw Schraube für Unterlage	Tork Anahtar Torx Key Torx-Schlüssel
E10M STFCR/L 09	●	○	10	9.5	150	6	12	TC.T 0902..	3007-M2.2x5	-	-	80-T07
E12Q STFCR/L 09	●	○	12	11	180	8	15					
E12Q STFCR/L 11	●	○	12	11	180	8	15					



KAPR=93°

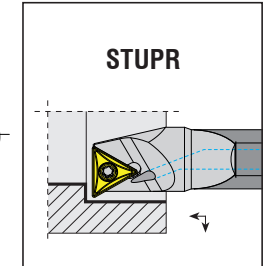
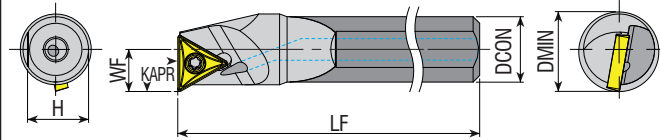

**Takım Kodu**  
**Ordering Code**  
**Bestell-Bezeichnung**

Stok Stock Lager	Takım Ölçüleri (mm) Dimension (mm) Abmessung (mm)						Kesici Uç Insert Wendeschneidplatte	Yedek Parçaları / Spare Parts / Ersatzteile				
	R	L	DCON	H	LF	WF		DMIN	Sıkma Vidası Screw Schraube	Altık Shim Unterlage	Altık Vidası Shim Screw Schraube für Unterlage	Tork Anahtar Torx Key Torx-Schlüssel
E12Q STUPR/L 1103	●	○	12	11	180	8	15	TP. 1103..	4010-M3x6	-	-	80-T10
E16R STUPR/L 1103	●	○	16	15	200	11	20					

R: Sağ / Right / Rechts L: Sol/Left/Links

● Stokta / In Stock / Auf Lager ○ Stokta Yok / Non Stock Item / Kein Lagerartikel, Lieferzeit auf Anfrage

Sipariş Örneği/Ordering Example/Bestellbeispiel

1 ad./pcs./stück E10M STFCR 09

SCLCR

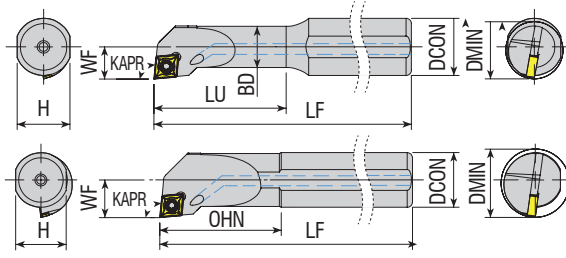
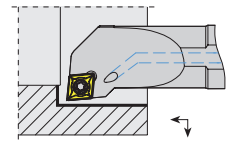

SET-A/SCLCR/L



Takım Kodu  
Ordering Code  
Bestell-Bezeichnung

Stok Stock Lager	Takım Ölçüleri (mm) Dimension (mm) Abmessung (mm)								Kesici Uç Insert Wendeschneidplatte	Yedek Parçaları / Spare Parts / Ersatzteile			
	R	L	DCON	BD	H	LU=OHN	LF	WF		DMIN	Sıkma Vidası Screw Schraube	Altık Shim Unterlage	Altık Vidası Shim Screw Schraube für Unterlage
● ●		8	8	7.3	20	100	6	≥11	CC.T 0602..	4008-M2.5x6	-	-	80-T08
● ●		10	10	9	25	100	7	≥13					
● ●		12	12	11	25	100	9	≥16					
● ●		16	16	14.8	35	150	11	≥20					

SCLCR

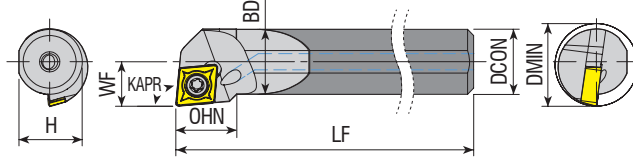
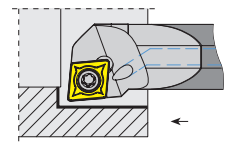

SET-E/SCLCR/L



Takım Kodu  
Ordering Code  
Bestell-Bezeichnung

Stok Stock Lager	Takım Ölçüleri (mm) Dimension (mm) Abmessung (mm)								Kesici Uç Insert Wendeschneidplatte	Yedek Parçaları / Spare Parts / Ersatzteile			
	R	L	DCON	BD	H	OHN	LF	WF		DMIN	Sıkma Vidası Screw Schraube	Altık Shim Unterlage	Altık Vidası Shim Screw Schraube für Unterlage
● ○		8	8	7.5	10	125	6	≥11	CC.T 0602..	4008-M2.5x6	-	-	80-T08
● ○		10	10	9.5	10	150	7	≥13					
● ○		12	12	11	12	180	9	≥16					
● ○		16	16	15	15	200	11	≥20					

SCLCR

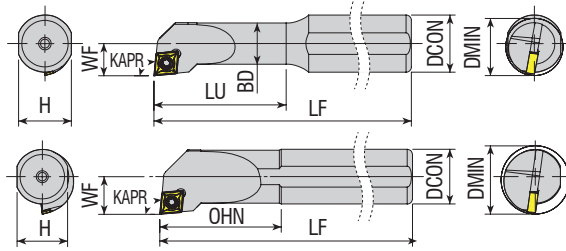
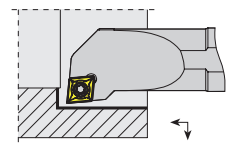

SET-S/SCLCR/L



Takım Kodu  
Ordering Code  
Bestell-Bezeichnung

Stok Stock Lager	Takım Ölçüleri (mm) Dimension (mm) Abmessung (mm)								Kesici Uç Insert Wendeschneidplatte	Yedek Parçaları / Spare Parts / Ersatzteile			
	R	L	DCON	BD	H	LU=OHN	LF	WF		DMIN	Sıkma Vidası Screw Schraube	Altık Shim Unterlage	Altık Vidası Shim Screw Schraube für Unterlage
● ●		8	8	7.3	20	100	6	≥11	CC.T 0602..	4008-M2.5x6	-	-	80-T08
● ●		10	10	9	25	125	7	≥13					
● ●		12	12	11	25	125	9	≥16					
● ●		16	16	14.8	35	170	11	≥20					

R: Sağ / Right / Rechts L: Sol/Left/Links ● Stokta / In Stock / Auf Lager ○ Stokta Yok / Non Stock Item / Kein Lagerartikel, Lieferzeit auf Anfrage

Sipariş Örneği/Ordering Example/Bestellbeispiel  
1 ad./pcs./stück A08H SCLCR 06

SET-A/SDUCR/L

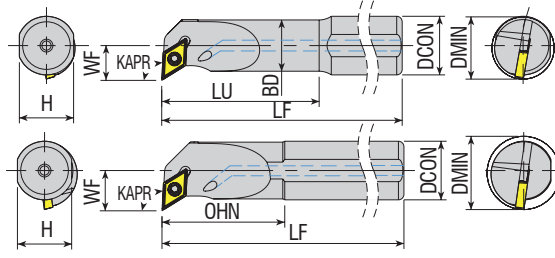

SDUCR

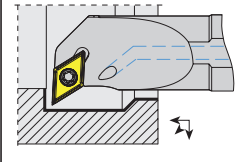

Takım Kodu  
Ordering Code  
Bestell-Bezeichnung

Stok  
Stock  
Lager

Takım Ölçüleri (mm)  
Dimension (mm)  
Abmessung (mm)

Kesici Uç  
Insert  
Wendeschneidplatte

Yedek Parçaları / Spare Parts / Ersatzteile

Sıkma Vidası  
Screw  
Schraube

Altlık  
Shim  
Unterlage

Altlık Vidası  
Shim Screw  
Schraube für Unterlage

Tork Anahtar  
Torx Key  
Torx-Schlüssel

R	L	DCON	BD	H	LU=OHN	LF	WF	DMIN
---	---	------	----	---	--------	----	----	------

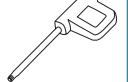
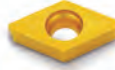

A10H SDUCR/L 07

●	●	10	10	09	25	100	08	≥13
---	---	----	----	----	----	-----	----	-----

DC.T 0702..

4008-M2.5x6

80-T08

A12H SDUCR/L 07

●	●	12	12	11	25	100	09	≥16
---	---	----	----	----	----	-----	----	-----

DC.T 11T3..

4015-M3.5x9

80-T15

A16M SDUCR/L 11

●	●	16	16	14.8	35	150	11	≥20
---	---	----	----	------	----	-----	----	-----

DC.T 11T3..

4015-M3.5x9

80-T15

SET-E/SDUCR/L

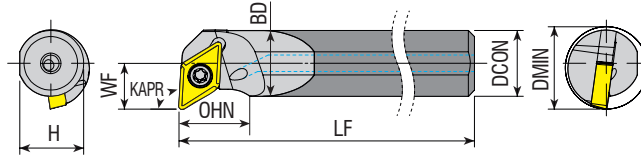

SDUCR

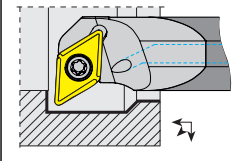

Takım Kodu  
Ordering Code  
Bestell-Bezeichnung

Stok  
Stock  
Lager

Takım Ölçüleri (mm)  
Dimension (mm)  
Abmessung (mm)

Kesici Uç  
Insert  
Wendeschneidplatte

Yedek Parçaları / Spare Parts / Ersatzteile

Sıkma Vidası  
Screw  
Schraube

Altlık  
Shim  
Unterlage

Altlık Vidası  
Shim Screw  
Schraube für Unterlage

Tork Anahtar  
Torx Key  
Torx-Schlüssel

R	L	DCON	BD	H	OHN	LF	WF	DMIN
---	---	------	----	---	-----	----	----	------

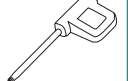
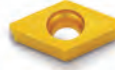

E10M SDUCR/L 07

●	○	10	10	9.5	09	150	8	≥13
---	---	----	----	-----	----	-----	---	-----

DC.T 0702..

4008-M2.5x6

80-T08

E12Q SDUCR/L 07

●	○	12	12	11	10	180	9	≥16
---	---	----	----	----	----	-----	---	-----

DC.T 11T3..

4015-M3.5x9

80-T15

E16R SDUCR/L 11

●	○	16	16	15	12	200	11	≥20
---	---	----	----	----	----	-----	----	-----

DC.T 11T3..

4015-M3.5x9

80-T15

SET-S/SDUCR/L

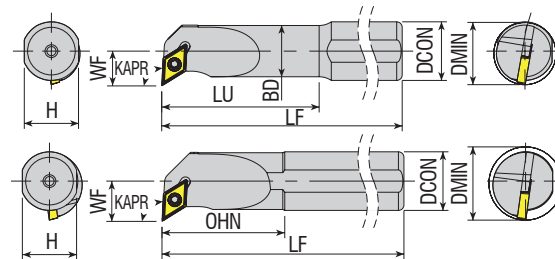

SDUCR

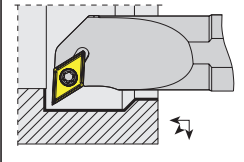

Takım Kodu  
Ordering Code  
Bestell-Bezeichnung

Stok  
Stock  
Lager

Takım Ölçüleri (mm)  
Dimension (mm)  
Abmessung (mm)

Kesici Uç  
Insert  
Wendeschneidplatte

Yedek Parçaları / Spare Parts / Ersatzteile

Sıkma Vidası  
Screw  
Schraube

Altlık  
Shim  
Unterlage

Altlık Vidası  
Shim Screw  
Schraube für Unterlage

Tork Anahtar  
Torx Key  
Torx-Schlüssel

R	L	DCON	BD	H	LU=OHN	LF	WF	DMIN
---	---	------	----	---	--------	----	----	------

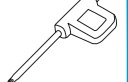
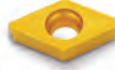

S10K SDUCR/L 07

●	●	10	10	9	25	125	8	≥13
---	---	----	----	---	----	-----	---	-----

DC.T 0702..

4008-M2.5x6

80-T08

S12K SDUCR/L 07

●	●	12	12	11	25	125	9	≥16
---	---	----	----	----	----	-----	---	-----

DC.T 11T3..

4015-M3.5x9

80-T15

S16P SDUCR/L 11

●	●	16	16	14.8	35	170	11	≥20
---	---	----	----	------	----	-----	----	-----

DC.T 11T3..

4015-M3.5x9

80-T15

R: Sağ / Right / Rechts L: Sol/Left/Links

● Stokta / In Stock / Auf Lager ○ Stokta Yok / Non Stock Item / Kein Lagerartikel, Lieferzeit auf Anfrage

Sipariş Örneği/Ordering Example/Bestellbeispiel

1 ad./pcs./stück SET-A/SDUCR





*konusulan*  
*the spoken kalite...*  
*quality...*

# TIRLAMAZ

**TIRLAMAZ TAKIMLAR**  
**ANTIVIBRATION TOOLS**  
**SCHWINGUNGSGEDÄMPFTE BOHRSTANGEN**



AKKO **A** **TT** **B** **D16** **204** **10D** **H** **E**

<b>2</b> Takım Tipi Tool Type Werkzeugtyp	<b>3</b> Gövde Body Schaft	<b>4</b> Bağlantı Çapı Connection Diameter Anschlussdurchmesser	<b>5</b> Takım Boyu Overall length Gesamtlänge	<b>6</b> Bağlama Boyu Overhang maximum Maximale Auskrägung	<b>7</b> İçten Soğutmalı With Coolant Hole Mit Innenkühlung
Tırlamaz Takım Anti Vibration Tool Schwingungsgedämpfte Bohrstanqe					
<b>8</b> Takım Malzemesi Type of Boring Bar Art der Bohrstanqe					
Karbür Takviyeli Carbide reinforced Hartmetall verstärkt					

AKKO **A** **TT** **C** **A** **16** **SDUCR11**

<b>2</b> Takım Tipi Tool Type Werkzeugtyp	<b>3</b> Kartuş Kodu Cartridge Code Bezeichnung für Wechselkopf	<b>4</b> İçten Soğutmalı With Coolant Hole Mit Innenkühlung	<b>5</b> Bağlama Çapı Connection Diameter Anschlussdurchmesser
Tırlamaz Takım Kartuşu Anti Vibration Tool Cartridge Wechselkopf für Schwingungsgedämpfte Bohrstanqe	Kartuş Cartridge Wechselkopf		Ø16 - Ø20 - Ø25 Ø32 - Ø40
<b>2</b> Kartuş Tipi Cartridge Type Wechselkopftyp			
SDUCR/L, SCLCR/L, SVUCR/L, TCLNR/L, TDUNR/L			

AKKO **A** **TT** **C** **16-25**

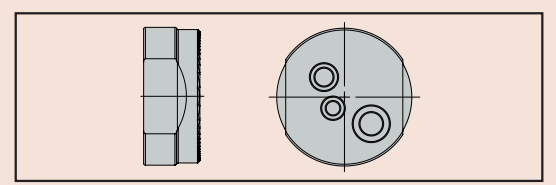

<b>2</b> Takım Tipi Tool Type Werkzeugtyp	<b>3</b> Kartuş Cartridge Wechselkopf	<b>4</b> Kullanılan Gövde Çap Aralığı Usable diameter range for body Nutzbarer Durchmesserbereich für Werkzeugschaft
Tırlamaz Takım Kartuşu Anti Vibration Tool Cartridge Wechselkopf für Schwingungsgedämpfte Bohrstanqen	Merkeleme Kartuş Kodu Centering Cartridge Code Bezeichnung für zentriertes Wechselkopf	ATTB-D16/D20/D25 ATTB-D32/D40/D50/D60

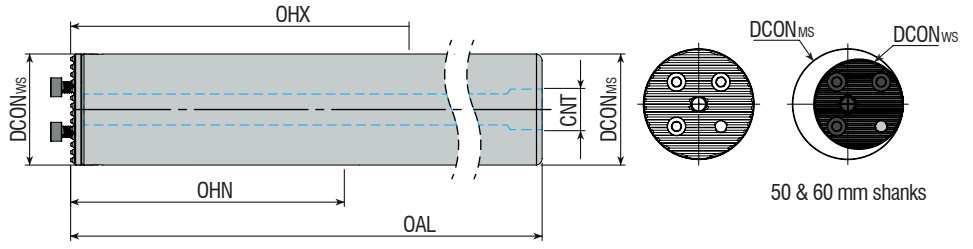

**Takım Kodu**  
**Ordering Code**  
**Bestell-Bezeichnung**

Stok  
Stock  
Lager

Takım Ölçüleri (mm)  
Dimension (mm)  
Abmessung (mm)

Yedek Parçaları / Spare Parts / Ersatzteile

Montaj Vidası  
Shim Screw  
Schraube für Unterlage

Montaj Vida Anahtar  
Mounting Screw Key  
Innensechskantschlüssel für Befestigungsschraube

Takım Kodu Ordering Code Bestell-Bezeichnung	Stok Stock Lager	DCONMS	DCONWS	OAL	OHN	OHX	CNT	DCON		Montaj Vidası Shim Screw Schraube für Unterlage	Montaj Vida Anahtar Mounting Screw Key Innensechskantschlüssel für Befestigungsschraube
								DCON	DMIN		
ATTB-D16-156-7D-H	○	16	16	156	55	92	G1/8	16	20	2525-M3X10	AAL-02-2.5
ATTB-D16-204-10D-H-E	○	16	16	204	96	140	G1/8	16	20		
ATTB-D20-200-7D-H	○	20	20	200	70	120	G1/4	20	25	M3.5X10	AAL-02-2.5
ATTB-D20-260-10D-H-E	○	20	20	260	120	180	G1/4	20	25		
ATTB-D25-255-7D-H	○	25	25	255	88	158	G1/4	25	32	2503-M4X12	AAL-03-3
ATTB-D25-330-10D-H	○	25	25	330	155	230	G1/4	25	32		
ATTB-D32-320-7D-H	○	32	32	320	100	192	G3/8	32	40	2504-M5X16	AAL-05-4
ATTB-D32-416-10D-H	○	32	32	416	192	288	G3/8	32	40		
ATTB-D40-408-7D-H	○	40	40	408	128	248	G1/2	40	50	2505-M6X16	AAL-07-5
ATTB-D40-528-10D-H	○	40	40	528	248	368	G1/2	40	50		
ATTB-D50-519-7D-H	●	50	40	519	168	318	G1/2	40	63	2505-M6X16	AAL-07-5
ATTB-D50-669-10D-H	○	50	40	669	318	468	G1/2	40	63		
ATTB-D60-628-7D-H	○	60	40	628	208	388	G3/4	40	80	2505-M6X16	AAL-07-5
ATTB-D60-808-10D-H	○	60	40	808	388	568	G3/4	40	80		

R: Sağ / Right / Rechts L: Sol/Left/Links

● Stokta / In Stock / Auf Lager ○ Stokta Yok / Non Stock Item / Kein Lagerartikel, Lieferzeit auf Anfrage

Sipariş Örneği/Ordering Example/Bestellbeispiel

1 ad./pcs./stück ATTB-D16-156-7D-H





KAPR=93°

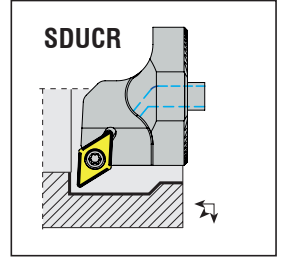
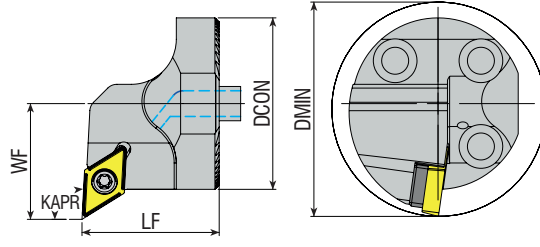

SDUCR

Takım Kodu Ordering Code Bestell-Bezeichnung	Stok Stock Lager		Takım Ölçüleri (mm) Dimension (mm) Abmessung (mm)				Kesici Uç Insert Wendeschneidplatte	Yedek Parçaları / Spare Parts / Ersatzteile			
	R	L	DCON	LF	WF	DMIN		Sıkma Vidası Screw Schraube	Altık Shim Unterlage	Altık Vidası Shim Screw Schraube für Unterlage	Tork Anahtar Torx Key Torx-Schlüssel
ATTC-A16 SDUCR/L 07	○	○	16	20	11	20	DC.T 0702..	4008-M2.5x6	-	-	80-T08
ATTC-A20 SDUCR/L 11	○	○	20	20	13	25		4015-M3.5x11	-	-	
ATTC-A25 SDUCR/L 11	○	○	25	23	17	32	DC.T 11T3..	4015-M3.5x12	-	AAV-08-M3.5x8	80-T15
ATTC-A32 SDUCR/L 11	○	○	32	32	22	40		4015-M3.5x14	AADN-2-0001	AAV-06-M3.5x11	
ATTC-A40 SDUCR/L 11	●	●	40	32	27	50					



KAPR=95°

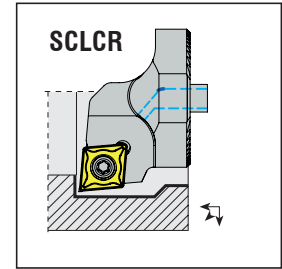
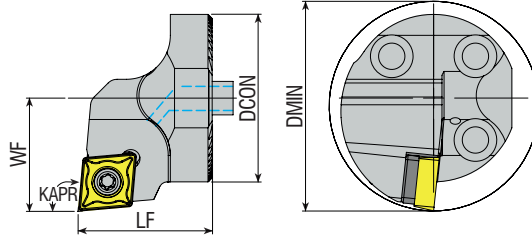

SCLCR

Takım Kodu Ordering Code Bestell-Bezeichnung	Stok Stock Lager		Takım Ölçüleri (mm) Dimension (mm) Abmessung (mm)				Kesici Uç Insert Wendeschneidplatte	Yedek Parçaları / Spare Parts / Ersatzteile			
	R	L	DCON	LF	WF	DMIN		Sıkma Vidası Screw Schraube	Altık Shim Unterlage	Altık Vidası Shim Screw Schraube für Unterlage	Tork Anahtar Torx Key Torx-Schlüssel
ATTC-A16 SCLCR/L 06	○	○	16	20	11	20	CC.T 0602..	4008-M2.5x6	-	-	80-T08
ATTC-A20 SCLCR/L 09	○	○	20	20	13	25		4015-M3.5x9	-	-	
ATTC-A25 SCLCR/L 09	○	○	25	23	17	32	CC.T 09T3..	4015-M3.5x12	AACN-2-0001	AAV-08-M3.5x8	80-T15
ATTC-A32 SCLCR/L 09	○	○	32	32	22	40					
ATTC-A40 SCLCR/L 12	●	●	40	32	27	50		CC.T 1204..	1020-M4.5x16	AACN-2-0003	

R: Sağ / Right / Rechts L: Sol/Left/Links

● Stokta / In Stock / Auf Lager ○ Stokta Yok / Non Stock Item / Kein Lagerartikel, Lieferzeit auf Anfrage

Sipariş Örneği/Ordering Example/Bestellbeispiel  
1 ad./pcs./stück ATTC-A16-SDUCR 07





KAPR=93°

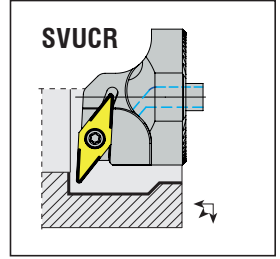
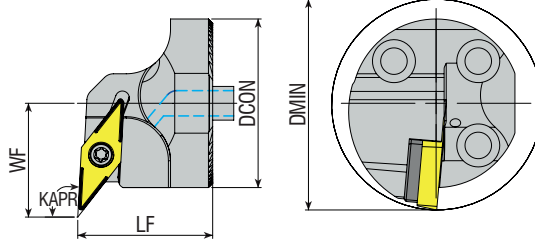

**Takım Kodu**  
**Ordering Code**  
*Bestell-Bezeichnung*

Stok Stock Lager	TAKIM ÖLÇÜLERİ (MM) DIMENSION (MM) ABMESSUNG (MM)					Kesici Uç Insert Wendeschneidplatte	Yedek Parçaları / Spare Parts / Ersatzteile				
	R	L	DCON	LF	WF		DMIN	SIKMA VIDASI SCREW SCHRAUBE	Altık Shim Unterlage	Altık Vidası Shim Screw Schraube für Unterlage	Tork Anahtar Torx Key Torx-Schlüssel
ATTC-A20 SVUCR/L 11	○	○	20	20	15	27		4008-M2.5x6	-	-	80-T08
ATTC-A25 SVUCR/L 11	○	○	25	23	17	32		4008-M2.5x6	-	-	80-T08
ATTC-A32 SVUCR/L 16	○	○	32	32	22	40		4015-M3.5x14	AAVN-2-0002	AAV-06-M3.5x11	80-T15
ATTC-A40 SVUCR/L 16	●	●	40	32	27	50		4015-M3.5x14	AAVN-2-0002	AAV-06-M3.5x11	80-T15



KAPR=93°

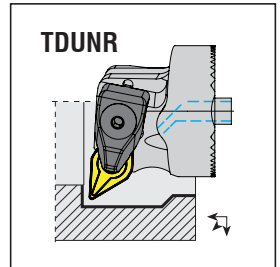
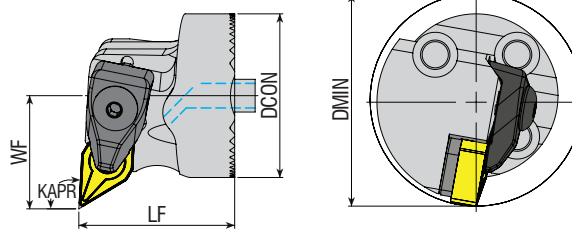

**Takım Kodu**  
**Ordering Code**  
*Bestell-Bezeichnung*

Stok Stock Lager	Takım Ölçüleri (mm) Dimension (mm) Abmessung (mm)					Kesici Uç Insert Wendeschneidplatte	Yedek Parçaları / Spare Parts / Ersatzteile							
	R	L	DCON	LF	WF		DMIN	Baskı Pabucu Wedge Clamp Spannpratze	Pabuç Vidası Clamp Screw Klemmschraube	Altık Shim Unterlage	Altık Vidası Shim Screw Schraube für Unterlage	Sekman Ring Feder	Pu Stamp Ring	Anahtar Allen Key Innerschlüssel
ATTC-A32 TDUNR/L 11	○	○	32	32	22	40		ATK-01	AKV-01-M5x22	AADN -2-0001	AAV-04-M5x12	AS-01	ABPL-01	AAL-03-3
ATTC-A40 TDUNR/L 15	●	●	40	38	27	50		ATK-02	AKV-30-M6x22	AADN -3-0001	AAV-02-M5x12	AS-01	ABPL-01	AAL-03-3

R: Sağ / Right / Rechts L: Sol/Left/Links

● Stokta / In Stock / Auf Lager ○ Stokta Yok / Non Stock Item / Kein Lagerartikel, Lieferzeit auf Anfrage

SİPARİŞ ÖRNEĞİ/ORDERING EXAMPLE/BESTELLEBEISPIEL

1 Ad./PCS./STÜCK ATTC-A20 SVUCR 11

**TIRLAMAZ TAKIMLARIN KARTUŞLARI**  
**ANTI VIBRATION TOOLS CARTRIDGES**  
 WECHSELKOPF FÜR SCHWINGUNGSGEDÄMPFTE BORSTANGE



KAPR=95°

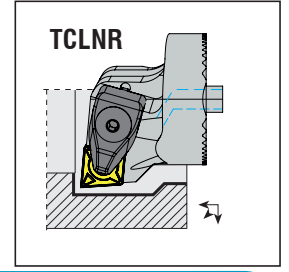
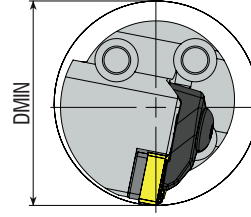
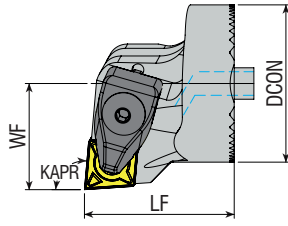

Takım Kodu Ordering Code Bestell-Bezeichnung	Stok Stock Lager		Takım Ölçüleri (mm) Dimension (mm) Abmessung (mm)				Kesici Uç Insert Wendeschneidplatte	Yedek Parçaları / Spare Parts / Ersatzteile									
	R	L	DCON	LF	WF	DMIN		Baskı Pabucu Wedge Clamp Spannpratze	Pabuç Vidası Clamp Screw Klemmschraube	Altlık Shim Unterlage	Altlık Vidası Shim Screw Schraube für Unterlage	Sekman Ring Feder	Pul Stamp Ring	Anahtar Allen Key Innensechskantschlüssel			
ATTC-A32 TCLNR/L 12	○	○	32	32	22	40	CNM. 1204..	ATK-02	AKV-30-M6x22	AACN -3-0001	AAV-02-M5x12	AS-01	ABPL-01	AAL-03-3			
ATTC-A40 TCLNR/L 12	●	●	40	38	27	50											

**TIRLAMAZ TAKIMLARIN MERKEZLEME APARATI**  
**ANTI VIBRATION TOOLS CENTERING INSTRUMENT**  
 ZENTRIERWERKZEUG FÜR SCHWINGUNGSGEDÄMPFTE BORSTANGE

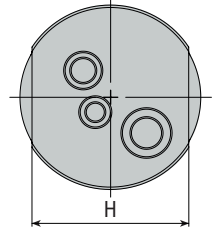
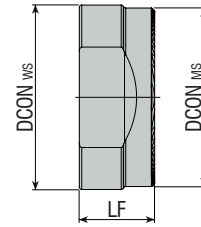

Takım Kodu Ordering Code Bestell-Bezeichnung	Stok Stock Lager	Takım Ölçüleri (mm) Dimension (mm) Abmessung (mm)				Gövde Tipi Boring Bars Art der Bohrstanze
		DCONWS	DCONMS	LF	H	
ATTC-16-25	●	28	25	15	22	ATTB-D16/D20/D25 ATTB-D32/D40/D50/D60
ATTC-32-60	●	53	40	20	35	

R: Sağ / Right / Rechts L: Sol/Left/Links  
 ● Stokta / In Stock / Auf Lager ○ Stokta Yok / Non Stock Item / Kein Lagerartikel, Lieferzeit auf Anfrage

Sipariş Örneği/Ordering Example/Bestellbeispiel  
 1 ad./pcs./stück ATTC-A32 TCLNR 12

**1 Montaj ve Ayarlama | Assembly and Adjusting | Montage und Einstellung**

Kartuş ve gövdenin montaj edilecek yüzeyleri, tutucunun iç kısmı temizlenmelidir. Aşağıdaki görselde A ve B konumlarına bakın.

The surface of the cartridge and the shank to be mounted, as well as the inner part of the toolholder should be cleaned. Check A and B in the image below.

Die Oberflächen des Wechselkopfes und des zu montierenden Schafts sowie der innere Teil des Werkzeughalters sollten gereinigt werden. Siehe A und B unten auf der Abbildung

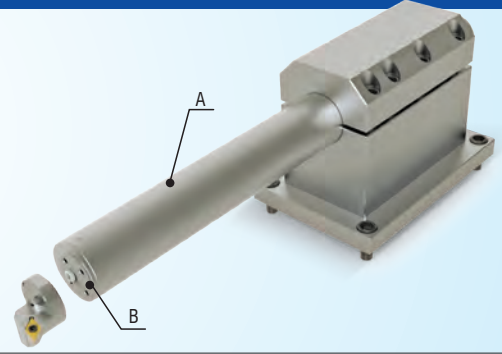
**2 Gövde Montajı | Assembly for the Shank | Schaftmontage**

Bağlama uzunluğu 4 L / D oranından az olmamalıdır. Tutucunun üst kısmını çıkartma yöntemiyle veya diğer tutma sıkma yöntemleriyle kullanmanızı öneririz (C tipi). Vidalı bağlama yöntemi kullanmayın. Uzun süre çalışırken lütfen içten soğutmayı kullanın.

The clamping length should not be less than 4 L/D ratio. Suggest using the clamping cover with opening method and other holding clamping methods. (Type C). Do not use screw clamping method. Use inner cooling please when working a long time.

Die Einspannlänge sollte nicht weniger als 4 L / D ratio betragen. Vorgeschlagen ist die Oberseite des Halters zu öffnen und andere Halte-Klemmethoden zu verwenden. (Typ C). Bitte nicht die Schraubklemmethode verwenden. Bei langer Nutzung, bitte die Innenkühlung verwenden.

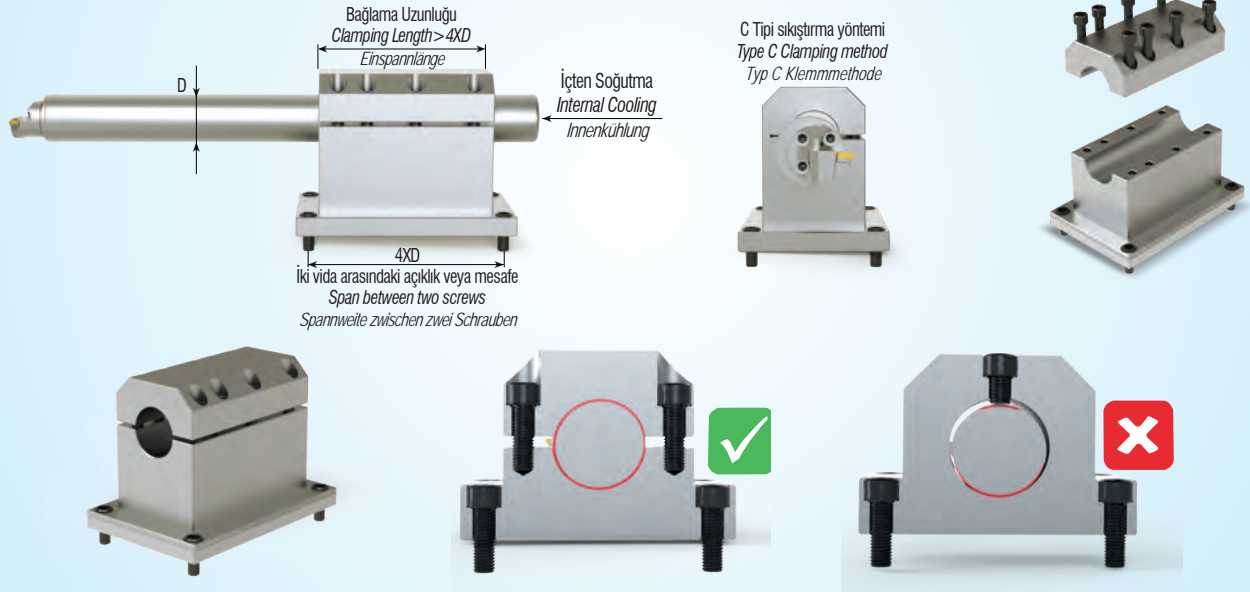
**3 Merkez Yüksekliğinin Ayarlanması | Adjusting the Height of Centre Assembly | Einstellung der Zentrumhöhe**

Gövdeyi ilk kez montaj ederken merkez yüksekliği için özel kalibrasyon aparatı kullanılmalıdır. Önce gövdeyi tutucuya monte edin, ardından X ekseninde 0,01 tolerans içinde kalibre edin. Lütfen komparatör saati ile ayarlamayı yapın.

When mounting the body for the first time, a special calibration tool should be used for the center height. First mount the shank on the holder, then calibrate it within 0.01 tolerance on the X axis direction. Please make the adjustment with the dial indicator device.

Bei der erstmaligen Montage des Schaftes sollte ein spezielles Kalibrierwerkzeug für die Zentrumhöhe verwendet werden. Montieren Sie zuerst den Schaft am Halter und kalibrieren Sie es dann innerhalb einer Toleranz von 0,01 in Richtung der X-Achse. Bitte benutzen Sie bei der Einstellung eine Messuhr

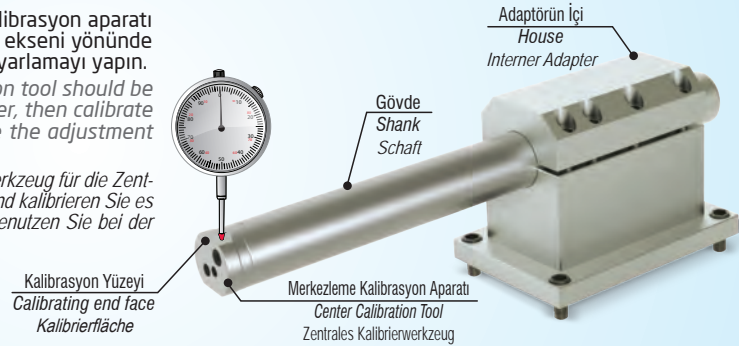
**4 Doğru Kartuş Montajı | Assembly the Right Cartridge | Richtige Wechselkopfmontage**

Yandaki şekle bakın:

See the figure on the side:

Siehe die Abbildung auf der Seite:

Sol Yön Takım  
Left Hand  
Linke Richtung



Sağ Yön Takım  
Right Hand  
Rechte Richtung



**Doğru Uç Seçimi / Choosing the Correct Insert / Auswahl der richtigen Wendeschneidplatte**

Doğru kesici ucun seçilmesi, titreşim sönümlenmenin genel başarısı üzerinde büyük bir etkiye sahiptir. Kesici ucun işleme stabilitesini artırabilmesinin ana yolu kesme kuvvetlerini en aza indirmektir. Titreşimleri ortadan kaldırmak için aşağıdaki adımlara uymanız gerekir: Mümkünse, her zaman kısa takımları kullanın. Aksi takdirde, titreşimi en aza indirmek için hızlarınızı azaltın.

*Choosing the correct insert can have a big influence on the overall success of vibration damping. The main way the insert can improve the machining stability is by minimizing the cutting forces. Following the guidelines below should be your first step to eliminate vibrations: If possible, use it always short drilling tools. Otherwise, reduce your speeds to minimize vibration.*

*Die Auswahl des richtigen Einsatzes kann einen großen Einfluss auf den Gesamterfolg der Schwingungsdämpfung haben. Die Wendeschneidplatte kann die Bearbeitungstabilität hauptsächlich durch Minimierung der Schneidkräfte verbessern. Das Befolgen der folgenden Richtlinien sollte Ihr erster Schritt sein, um Vibrationen zu beseitigen: Verwenden Sie nach Möglichkeit immer kurze Werkzeuge. Reduzieren Sie andernfalls die Geschwindigkeit, um Vibrationen zu minimieren.*

**A** Radyal kuvvetleri minimuma indirmek için mümkün olduğunca 90°'ye yakın bir giriş açılı takımı seçin.

*Choose an entry angle that is as close as possible to 90° to reduce the radial forces to a minimum.*

*Wählen Sie einen Eintrittswinkel, der so nah wie möglich an 90° liegt, um die Radialkräfte auf ein Minimum zu reduzieren.*

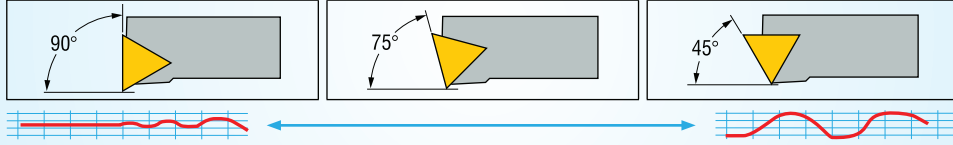

**B** Mümkün olan en küçük kesici uç açısını seçin. Böylece kesme kuvvetleri azalacak ve yüzey kalitesi artacak.

*Choose the smallest insert head angle possible. This will reduce overall cutting forces and increase the clearance.*

*Wählen Sie den kleinstmöglichen Wendeschneidplattenwinkel. Damit wird sich die Gesamtschneidkraft verringern und die Klarheit verbessern.*

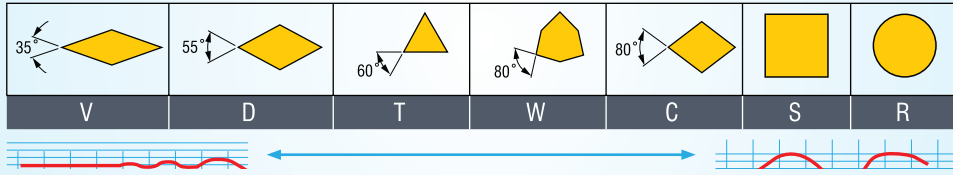

**C** Titreşimi azaltmak için olabildiğince en küçük radyüslü ucu seçmelisiniz.

*Choose a small nose radius to reduce the cutting forces and to enable machining in a lower depth of cut.*

*Wählen Sie einen Eintrittswinkel, der so nah wie möglich an 90° liegt, um die Radialkräfte auf ein Minimum zu reduzieren.*

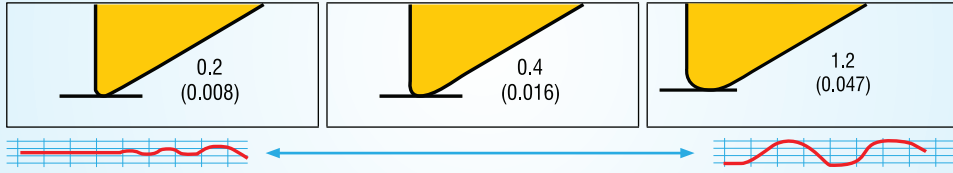

**D** İşleme derinliği (ap) radyüsten daha büyük olmalıdır.

*Machining depth (ap) should be larger than the nose radius.*

*Die Bearbeitungstiefe (ap) sollte größer als der Schneideckenradius sein.*

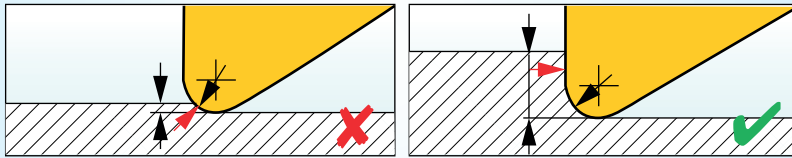

**E** Kesme kuvvetlerini azaltmak için daha pozitif geometriye sahip bir kesici uç kullanın:

*Use an insert with an overall positive geometry to reduce the cutting forces:*

*Verwenden Sie eine Wendeschneidplatte mit insgesamt positiver Geometrie, um die Schneidkräfte zu reduzieren:*

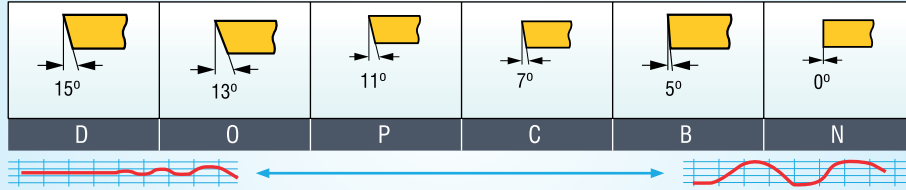

**F** Pozitif bir üst eğim geometrisi seçin:

*Choose a positive top rake geometry:*

*Benutzen Sie einen positiven, oberen Spanwinkel:*

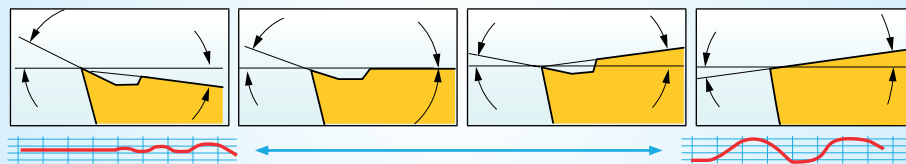

**G** For-damped-straight-adaptor:



*L, kesildikten sonra min uzunluk*  
*L, min length after cut off*  
*L, min Länge nach dem Abschneiden*

Ø	Kısa Tasarım Short Design Kurzes Design 4-7x Ø (mm)	Uzun Tasarım Long Design Langes Design 7-10x Ø (mm)
16	100	155
20	125	200
25	155	255
32	190	320
40	240	410
50	305	520
60	380	630





*konusulan*  
*the spoken kalite...*  
*quality...*

# KARTUŞLAR

KARTUŞLAR  
CARTRIDGE  
KURZDREHHALTER



S

1

T

2

F

3

C

4

R

5

12

6

C

7

A

8

16

9

1 Sıkma Tipi / Method of Mounting of Insert / Klemmsystem



Deliksiz Üstten Sıkma  
Top Clamping Without Hole  
Prattenklemmung

C



Delikten Levye ile Sıkma  
Hole Clamping (Lever Lock)  
Kniehebel-Spannsystem

P



Vida ile Sıkma  
Screw on  
Schrauben-Spannsystem

S

2 Uç Tipi / Type of Insert / Plattenform



C



S



T

3 Yanaşma Açısı / Tool Holder Shape Bar Geometry / Anstellwinkel



L



S



F

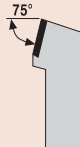

R



K



G



W



T

4 Serbest Uç Açısı / Insert Clearance Angle / Freiwinkel



C



P



N

5 Kesme Yönü / Cutting Direction / Halterausführung

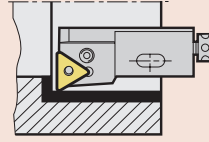

R

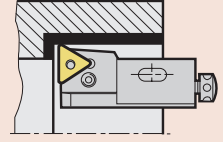

L

6 Kesme Kenar Yüksekliği / Cutting Edge Height / Drehhalterhöhe

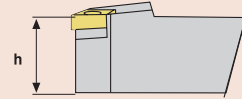

7 Kartuş Kodu / Cartridge Code / Wechselkopfbezeichnung

C  
(Kartuş / Cartridge Code / Kurzdrehhalter Bezeichnung)

8 Kartuş Tipi / Cartridge Type / Wechselkopftyp

A  
(ISO 5611)

9 Kesme Kenar Uzunluğu / Cutting Edge Length / Halterausführung

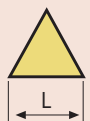

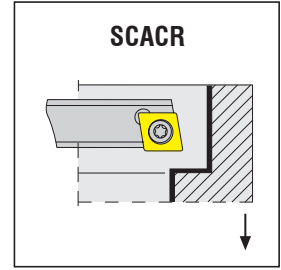
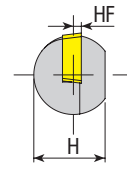
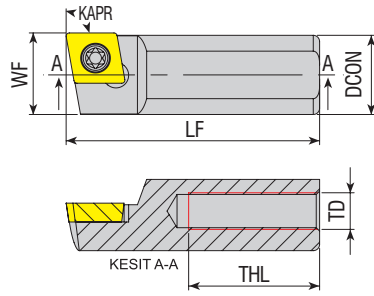

**Takım Kodu**  
**Ordering Code**  
**Bestell-Bezeichnung**

Stok  
Stock  
Lager

Takım Ölçüleri (mm)  
Dimension (mm)  
Abmessung (mm)

Kesici Uç  
Insert  
Wendeschneidplatte

Yedek Parçaları / Spare Parts / Ersatzteile

Sıkma Vidası  
Screw  
Schraube

Tork Anahtar  
Torx Key  
Torx-Schlüssel

R L

DCON

H

LF

THL

HF

WF

TD



Takım Kodu Ordering Code Bestell-Bezeichnung	R	L	DCON	H	LF	THL	HF	WF	TD
S10X SCACR/L 06	●	●	10	9	25	10	1	10.3	M5x0.8
S10A SCACR/L 06	●	●	10	9	32	15	1	10.3	M5x0.8
S1018 SCACR/L 06	○	●	10	9	18	8	1	9.8	M5x0.8
S1065 SCACR/L 06	○	●	10	9	65	25	1	10.3	M5x0.8
S10C SCACR/L 06	●	●	10	9	50	25	1	10.3	M5x0.8
S12B SCACR/L 06	●	●	12	11	40	25	1	12.3	M5x0.8
S12D SCACR/L 06	●	●	12	11	60	25	1	12.3	M5x0.8
S12D SCACR/L 09	●	●	12	11	60	25	2	12.2	M5x0.8
S1265 SCACR/L 09	○	●	12	11	65	25	2	12.3	M5x0.8
S12H SCACR/L 09	●	●	12	11	100	25	2	12.2	M5x0.8
S15C SCACR/L 09	●	●	15	14	50	25	2	15.3	M8x1.25
S1554 SCACR/L 09	○	●	15	14	54	25	2	15.3	M8x1.25
S15E SCACR/L 09	○	●	15	14	70	45	2	15.3	M8x1.25
S15D SCACR/L 09	○	●	15	14	60	30	2	15.3	M8x1.25
S16A SCACR/L 09	●	●	16	15	32	15	2	16.5	M6x1
S16B SCACR/L 09	●	●	16	15	40	20	2	16.5	M6x1
S16C SCACR/L 09	○	●	16	15	50	25	2	16.5	M6x1
S16D SCACR/L 09	●	●	16	15	60	30	2	16.5	M6x1
S16E SCACR/L 09	○	●	16	15	70	30	2	16.5	M6x1
S16G SCACR/L 09	●	●	16	15	90	30	2	16.5	M6x1
S16H SCACR/L 09	○	●	16	15	100	35	4	16.5	M6x1
S1868 SCACR/L 09	○	●	18	17	68	30	2	18.5	M8x1.25
S18E SCACR/L 09	●	●	18	17	70	30	2	18.5	M8x1.25
S1888 SCACR/L 09	○	●	18	17	88	30	2	18.5	M8x1.25
S18105 SCACR/L 09	○	●	18	17	105	30	2	18.5	M8x1.25
S18175 SCACR/L 09	○	●	18	17	175	30	2	18.5	M8x1.25
S20E SCACR/L 09	●	●	20	18.3	70	30	2	20.5	M6x1
S20E SCACR/L 12	●	●	20	18.3	70	30	2	20.5	M6x1
S20H SCACR/L 12	●	●	20	18.3	100	30	2	20.5	M6x1

CC.. 0602..

4008-M2.5x6

80-T08

CC.. 09T3..

4015-M3.5x8

80-T15

CC.. 1204..

1020-M5x11

80-T20

R: Sağ / Right / Rechts L: Sol/Left/Links

● Stokta / In Stock / Auf Lager ○ Stokta Yok / Non Stock Item / Kein Lagerartikel, Lieferzeit auf Anfrage

Sipariş Örneği/Ordering Example/Bestellbeispiel

1 ad./pcs./stück S10X SCACR 06

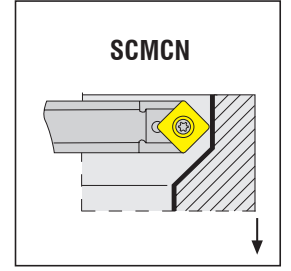
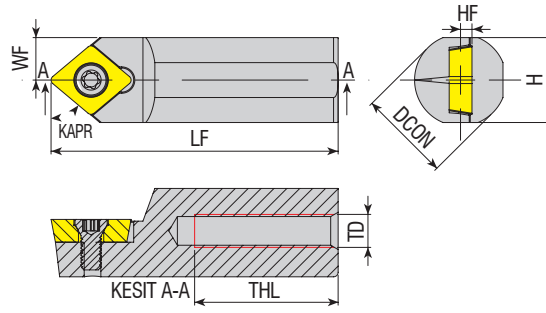

Takım Kodu Ordering Code Bestell-Bezeichnung	Stok Stock Lager	Takım Ölçüleri (mm) Dimension (mm) Abmessung (mm)							Kesici Uç Insert Wendeschneidplatte	Yedek Parçaları / Spare Parts / Ersatzteile		
		DCON	H	LF	THL	HF	WF	TD		Sıkma Vidası Screw Schraube	Tork Anahtar Torx Key Torx-Schlüssel	
S10X SCMCN 06	●	10	9	25	10	1	5	M5x0.8	CC.. 0602..	4008-M2.5x6	80-T08	
S12D SCMCN 06	●	12	11	60	25	1	6	M5x0.8				
S16C SCMCN 09	●	16	15	50	25	2	8	M6x1	CC.. 09T3..	4015-M3.5x11	80-T15	
S16D SCMCN 09	●	16	15	60	25	4	8	M6x1				

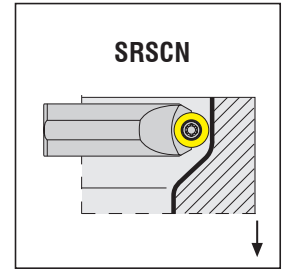
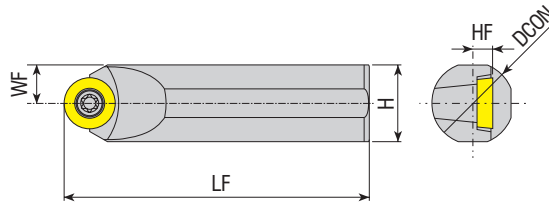

Takım Kodu Ordering Code Bestell-Bezeichnung	Stok Stock Lager	Takım Ölçüleri (mm) Dimension (mm) Abmessung (mm)					Kesici Uç Insert Wendeschneidplatte	Yedek Parçaları / Spare Parts / Ersatzteile		
		DCON	H	WF	HF	LF		Sıkma Vidası Screw Schraube	Tork Anahtar Torx Key Torx-Schlüssel	
S12D SRSCN 10	●	12	11	6	3.9	60	RC. 10T3	4015-M3.5x9	80-T15	
S14D SRSCN 10	●	14	13	7	3.9	60		4015-M3.5x11		
S16D SRSCN 10	●	16	15	8	3.9	60				

R: Sağ / Right / Rechts L: Sol/Left/Links

● Stokta / In Stock / Auf Lager ○ Stokta Yok / Non Stock Item / Kein Lagerartikel, Lieferzeit auf Anfrage

Sipariş Örneği/Ordering Example/Bestellbeispiel

1 ad./pcs./stück S10X SCMCN 06



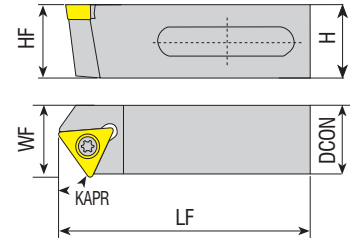

Takım Kodu Ordering Code Bestell-Bezeichnung	Stok Stock Lager		Takım Ölçüleri (mm) Dimension (mm) Abmessung (mm)					Kesici Uç Insert Wendeschneidplatte	Yedek Parçaları / Spare Parts / Ersatzteile		
	R	L	DCON	H	HF	LF	WF		Sıkma Vidası Screw Schraube	Tork Anahtar Torx Key Torx-Schlüssel	
STXCR/L 2020 B16	○	●	20	20	20	45	20	TC.. 16T3..	4015-M3.5x11	80-T15	
STXCR/L 2020 E16	○	●	20	20	20	70	20				
STXCR/L 2020 B16-SA	○	●	20	10	20	45	20				
STXCR/L 2020 E16-SA	○	●	20	10	20	70	20				
STXCR/L 2020 B16-PL	○	●	20	10	20	45	20				
STXCR/L 2020 E16-PL	○	●	20	10	20	70	20				
STXCR/L 2020 H16-PL	○	●	20	10	20	100	20				

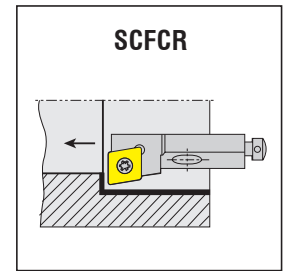
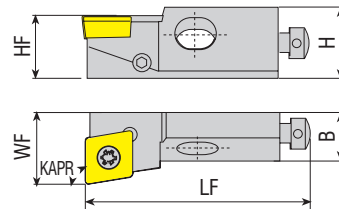
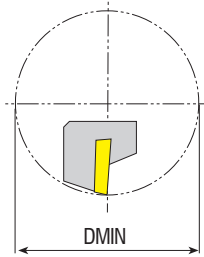

Takım Kodu Ordering Code Bestell-Bezeichnung	Stok Stock Lager		Takım Ölçüleri (mm) Dimension (mm) Abmessung (mm)						Kesici Uç Insert Wendeschneidplatte	Yedek Parçaları / Spare Parts / Ersatzteile			
	R	L	HF	H	B	LF	WF	DMIN		Altlık Shim Unterlage	Altlık Vidası Shim Screw Schraube für Unterlage	Sıkma Vidası Screw Schraube	Tork Anahtar Torx Key Torx-Schlüssel
SCFCR/L 06CA 06	●	●	6	8.5	6	25	8	≥20	CC.T 060204	-	-	4008-M2.5x6	80-T08
SCFCR/L 08CA 06	●	●	8	11	8	32	10	≥25					
SCFCR/L 10CA 09	●	●	10	15	11	50	14	≥40	CC.T 09T308	-	-	4015-M3.5x9	80-T15
SCFCR/L 12CA 12	●	○	12	20	15	55	20	≥50					
SCFCR/L 16CA 12	●	●	16	21	20	63	25	≥60	CC.T 120408	AACN-2-0003	AAV-10-M4.5x8	4020-M4.5x12	80-T20

R: Sağ / Right / Rechts L: Sol/Left/Links

● Stokta / In Stock / Auf Lager ○ Stokta Yok / Non Stock Item / Kein Lagerartikel, Lieferzeit auf Anfrage

Sipariş Örneği/Ordering Example/Bestellbeispiel

1 ad./pcs./stück STXCR 2020 B16

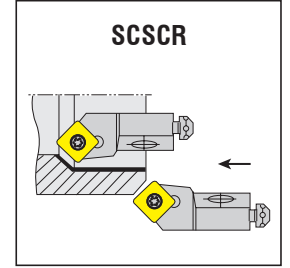
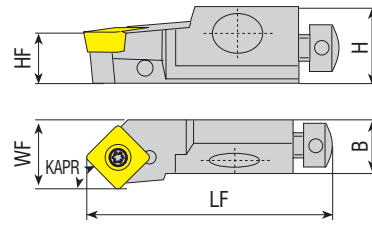
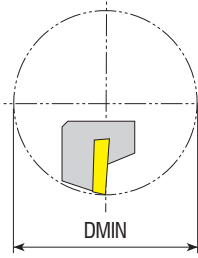

Takım Kodu Ordering Code Bestell-Bezeichnung	Stok Stock Lager		Takım Ölçüleri (mm) Dimension (mm) Abmessung (mm)						Kesici Uç Insert Wendeschneidplatte	Yedek Parçaları / Spare Parts / Ersatzteile			
	R	L	HF	H	B	LF	WF	DMIN		Altık Shim Unterlage	Altık Vidası Shim Screw Schraube für Unterlage	Sıkma Vidası Screw Schraube	Tork Anahtar Torx Key Torx-Schlüssel
SCSCR/L 06CA 06	●	○	6	8	6	30	8	≥20	CC.T 060204	-	-	4008-M2.5x6	80-T08
SCSCR/L 10CA 09	●	○	10	15	11	50	14	≥40	CC.T 09T308	-	-	4015-M3.5x9	80-T15
SCSCR/L 12CA 12	○	○	12	20	15	55	20	≥50	CC.T 120408	-	-	1020-M5x11	80-T20

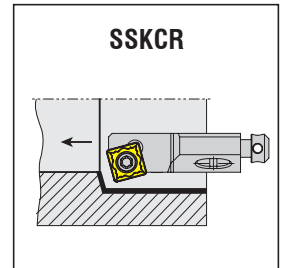
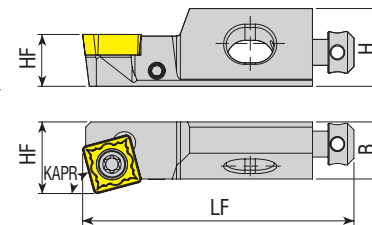
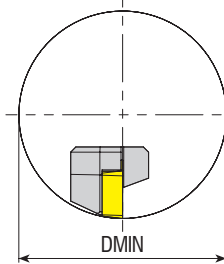

Takım Kodu Ordering Code Bestell-Bezeichnung	Stok Stock Lager		Takım Ölçüleri (mm) Dimension (mm) Abmessung (mm)						Kesici Uç Insert Wendeschneidplatte	Yedek Parçaları / Spare Parts / Ersatzteile			
	R	L	HF	H	B	LF	WF	DMIN		Altık Shim Unterlage	Altık Vidası Shim Screw Schraube für Unterlage	Sıkma Vidası Screw Schraube	Tork Anahtar Torx Key Torx-Schlüssel
SSKCR/L 10CA 09	●	○	10	15	11	50	14	≥40	SC.T 09T308	-	-	4015-M3.5x9	80-T15
SSKCR/L 12CA 12	●	○	12	20	15	55	20	≥50	SC.T 120408	-	-	1020-M5x11	80-T20

R: Sağ / Right / Rechts L: Sol/Left/Links  
● Stokta / In Stock / Auf Lager ○ Stokta Yok / Non Stock Item / Kein Lagerartikel, Lieferzeit auf Anfrage

Sipariş Örneği/Ordering Example/Bestellbeispiel  
1 ad./pcs./stück SCSCR 06CA 06

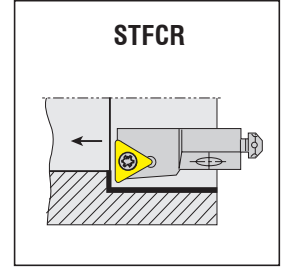
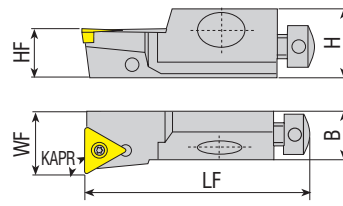
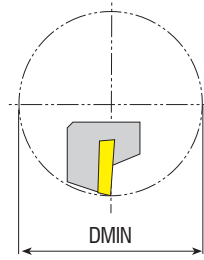

Takım Kodu Ordering Code Bestell-Bezeichnung	Stok Stock Lager		Takım Ölçüleri (mm) Dimension (mm) Abmessung (mm)						Kesici Uç Insert Wendeschneidplatte	Yedek Parçaları / Spare Parts / Ersatzteile			
	R	L	HF	H	B	LF	WF	DMIN		Altık Shim Unterlage	Altık Vidası Shim Screw Schraube für Unterlage	Sıkma Vidası Screw Schraube	Tork Anahtar Torx Key Torx-Schlüssel
STFCR/L 08CA 09	●	●	8	11	8	32	10	≥25	TC.T 090204	-	-	3007-M2.2x5	80-T07
STFCR/L 10CA 11	●	●	10	15	11	50	14	≥40	TC.T 110204	-	-	4008-M2.5x6	80-T08
STFCR/L 12CA 16	●	○	12	20	15	55	20	≥50	TC.T 16T308	-	-	4015-M3.5x11	80-T15
STFCR/L 16CA 16	●	●	16	21	20	63	25	≥60		AATN-2-0001	AAV-06-M3.5x11	4015-M3.5x14	

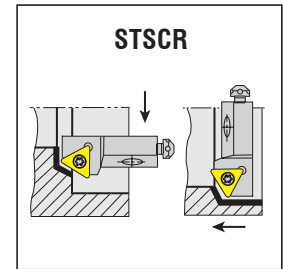
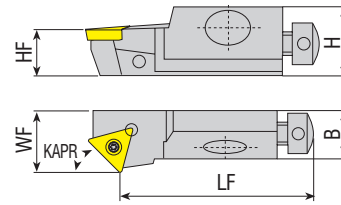
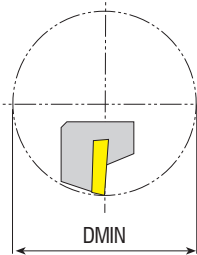

Takım Kodu Ordering Code Bestell-Bezeichnung	Stok Stock Lager		Takım Ölçüleri (mm) Dimension (mm) Abmessung (mm)						Kesici Uç Insert Wendeschneidplatte	Yedek Parçaları / Spare Parts / Ersatzteile			
	R	L	HF	H	B	LF	WF	DMIN		Altık Shim Unterlage	Altık Vidası Shim Screw Schraube für Unterlage	Sıkma Vidası Screw Schraube	Tork Anahtar Torx Key Torx-Schlüssel
STSCR/L 08CA 09	●	○	8	11	8	28	10	≥25	TC.T 090204	-	-	3007-M2.2x5	80-T07
STSCR/L 10CA 11	●	●	10	15	11	44	14	≥40	TC.T 110204	-	-	4008-M2.5x6	80-T08
STSCR/L 12CA 16	●	○	12	20	15	47	20	≥50	TC.T 16T308	-	-	4015-M3.5x11	80-T15

R: Sağ / Right / Rechts L: Sol/Left/Links

● Stokta / In Stock / Auf Lager ○ Stokta Yok / Non Stock Item / Kein Lagerartikel, Lieferzeit auf Anfrage

Sipariş Örneği/Ordering Example/Bestellbeispiel

1 ad./pcs./stück STFCR 08CA 09

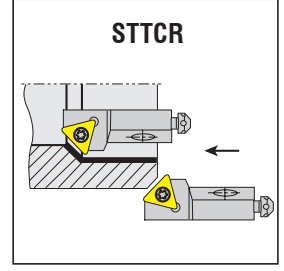
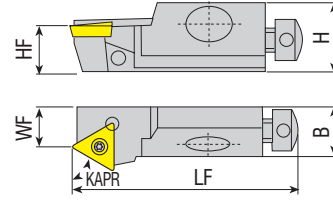
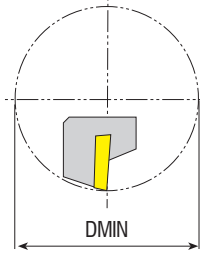

Takım Kodu Ordering Code Bestell-Bezeichnung	Stok Stock Lager		Takım Ölçüleri (mm) Dimension (mm) Abmessung (mm)						Kesici Uç Insert Wendeschneidplatte	Yedek Parçaları / Spare Parts / Ersatzteile			
	R	L	HF	H	B	LF	WF	DMIN		Altık Shim Unterlage	Altık Vidası Shim Screw Schraube für Unterlage	Sıkma Vidası Screw Schraube	Tork Anahtar Torx Key Torx-Schlüssel
STTCR/L 08CA 09	●	●	8	11	8	32	6	≥25	TC.T 090204	-	-	3007-M2.2x5	80-T07
STTCR/L 10CA 11	●	●	10	15	11	50	9	≥40	TC.T 110204	-	-	4008-M2.5x6	80-T08

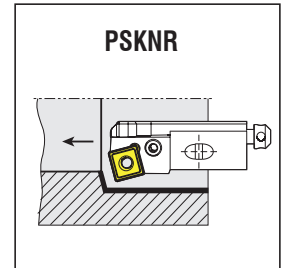
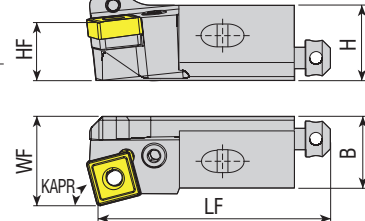
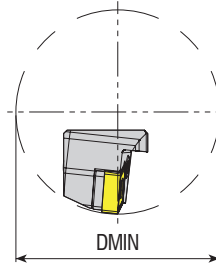

Takım Kodu Ordering Code Bestell-Bezeichnung	Stok Stock Lager		Takım Ölçüleri (mm) Dimension (mm) Abmessung (mm)						Kesici Uç Insert Wendeschneidplatte	Yedek Parçaları / Spare Parts / Ersatzteile				
	R	L	HF	H	B	LF	WF	DMIN		Levyé Lever Kniehebel	Levyé Vidası Lever Screw Kniehebelschraube	Altık Shim Unterlage	Altık Yayı Shim Spring Feder für Unterlage	Anahtar Allen Key Innerschraubenschlüssel
PSKNR/L 16CA 12	●	●	16	21	20	63	25	≥60	SNM.120408	APL-02	ALV-08-M8x16	AASN-3-0004	AAY-02	AAL-02-2.5

R: Sağ / Right / Rechts L: Sol/Left/Links

● Stokta / In Stock / Auf Lager ○ Stokta Yok / Non Stock Item / Kein Lagerartikel, Lieferzeit auf Anfrage

Sipariş Örneği/Ordering Example/Bestellbeispiel  
1 ad./pcs./stück STTCR 08CA 09



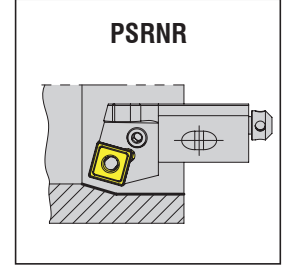
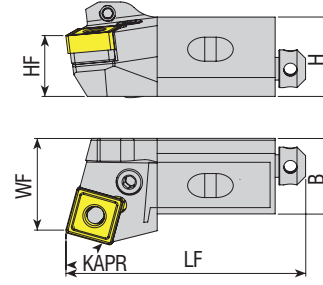
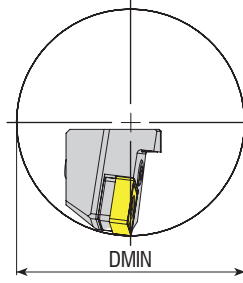

**Takım Kodu**  
**Ordering Code**  
**Bestell-Bezeichnung**

Stok Stock Lager	Takım Ölçüleri (mm) Dimension (mm) Abmessung (mm)								Kesici Uç Insert Wendeschneidplatte	Yedek Parçaları / Spare Parts / Ersatzteile				
	R	L	HF	H	B	LF	WF	DMIN		Levyeye Lever Kniehebel	Levyeye Vidası Lever Screw Kniehebelschraube	Altılık Shim Unterlage	Altılık Yayı Shim Spring Feder für Unterlage	Anahtar Allen Key Innerschlüsselschlüssel
	○	●	16	21	20	63	25	≥60						
<b>PSRNR/L 16CA 12</b>	○	●	16	21	20	63	25	≥60	<b>SNM.120408</b>	<b>APL-02</b>	<b>ALV-03-M8x19</b>	<b>AASN-3-0004</b>	<b>AAY-02</b>	<b>AAL-03-3</b>

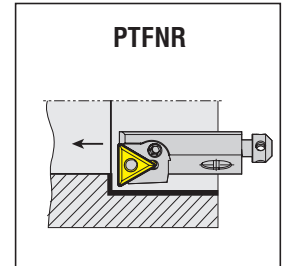
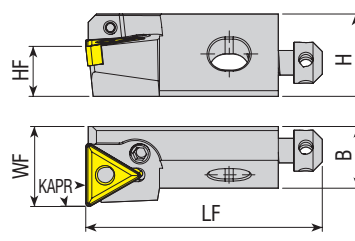
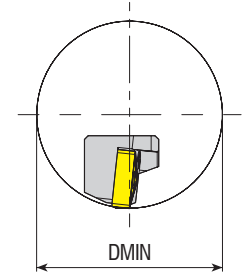

**Takım Kodu**  
**Ordering Code**  
**Bestell-Bezeichnung**

Stok Stock Lager	Takım Ölçüleri (mm) Dimension (mm) Abmessung (mm)								Kesici Uç Insert Wendeschneidplatte	Yedek Parçaları / Spare Parts / Ersatzteile				
	R	L	HF	H	B	LF	WF	DMIN		Levyeye Lever Kniehebel	Levyeye Vidası Lever Screw Kniehebelschraube	Altılık Shim Unterlage	Altılık Yayı Shim Spring Feder für Unterlage	Anahtar Allen Key Innerschlüsselschlüssel
	●	●	12	20	15	47	20	≥50						
<b>PTFNR/L 12CA 16</b>	●	●	12	20	15	47	20	≥50	<b>TNM.160408</b>	<b>APL-08</b>	<b>ALV-07-M6x13</b>	-	<b>AAY-07</b>	<b>AAL-02-2.5</b>
<b>PTFNR/L 16CA 16</b>	●	○	16	21	20	63	25	≥60		<b>APL-01</b>	<b>ALV-01-M6x14</b>	<b>AATN-3-0025</b>	<b>AAY-01</b>	

R: Sağ / Right / Rechts L: Sol/Left/Links  
● Stokta / In Stock / Auf Lager ○ Stokta Yok / Non Stock Item / Kein Lagerartikel, Lieferzeit auf Anfrage

Sipariş Örneği/Ordering Example/Bestellbeispiel  
1 ad./pcs./stück PSRNR 16CA 12

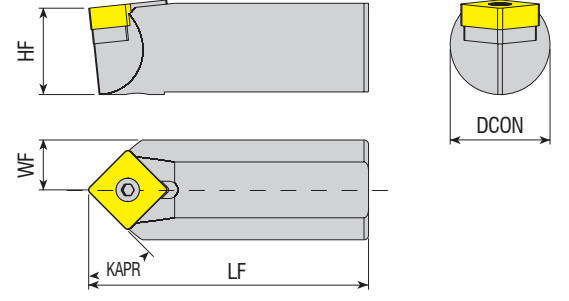

Takım Kodu Ordering Code Bestell-Bezeichnung	Stok Stock Lager	Takım Ölçüleri (mm) Dimension (mm) Abmessung (mm)				Kesici Uç Insert Wendeschneidplatte	Yedek Parçaları / Spare Parts / Ersatzteile				
		DCON	HF	LF	WF		Atlık Shim Unterlage	Sıkma Vidası Screw Schraube	Baskı Parçası Wedge Clamp Spannpratze	Baskı Vidası Clamp Screw Klemmschraube	Tork Anahtar Torx Key Torx-Schlüssel
<b>S22D PSDNN 12C</b>	●	22	19.5	65	11						
						<b>SNM. 1204..</b>	AASN-20020	AEV-01-M6x16	ACK-05	4015-M4x11	AAL-02-2.5

R: Sağ / Right / Rechts L: Sol/Left/Links

● Stokta / In Stock / Auf Lager ○ Stokta Yok / Non Stock Item / Kein Lagerartikel, Lieferzeit auf Anfrage

Sipariş Örneği/Ordering Example/Bestellbeispiel

1 ad./pcs./stück S22D PSDNN 12C

KARTUŞLARIN YEDEK PARÇALARI  
SPARE PARTS OF CARTRIDGE  
ERSATZTEILE FÜR KURZDREHHALTER

Takım Kodu Ordering Code Bestell-Bezeichnung	Yedek Parçaları / Spare Parts / Ersatzteile					
	Eksenel Ayar Vida Axial Adj. Screw Axial-Einstellschraube	Radyal Ayar Vida Radial Adj. Screw Radial-Einstellschraube	Radyal Ayar Vida Anahtar Radial Adj. Screw Allen Key Immersechenschlüssel für Radial-Einstellschraube	Montaj Vida Mounting Screw Befestigungsschraube	Montaj Vida Anahtar Mounting Screw Allen Key Immersechenschlüssel für Befestigungsschraube	
<b>SCFCR/L</b>	06CA 06	2600-M4x9.5	2715-M3x5	AAL-09-1.5	AKV-23-M4x10	AAL-03-3
<b>SCSCR/L</b>	08CA 06	2600-M4x9.5	2715-M3x5	AAL-09-1.5	AKV-23-M4x10	AAL-03-3
<b>SSKCR/L</b>	10CA 09	2600-M5x13	2702-M4x10	AAL-01-2	2505-M6x16	AAL-03-3
	12CA 12	2600-M5x13	2702-M4x10	AAL-01-2	2505-M6x16	AAL-03-3
	16CA 12	2600-M6x18	2725-M5x12	AAL-02-2.5	2005-M8x25	AAL-07-5
<b>STSCR/L</b>	08CA 09	2600-M4x9.5	2715-M3x5	AAL-09-1.5	AKV-23-M4x10	AAL-03-3
<b>STTCR/L</b>	10CA 11	2600-M5x13	2702-M4x10	AAL-01-2	2505-M6x16	AAL-03-3
<b>STFCR/L</b>	12CA 16	2600-M5x13	2702-M4x10	AAL-01-2	2505-M6x16	AAL-03-3
	16CA 16	2600-M6x18	2725-M5x12	AAL-02-2.5	2005-M8x25	AAL-07-5
<b>PTFNR/L</b>	12CA 16	2600-M5x13	2702-M4x4	AAL-01-2	2505-M6x16	AAL-03-3
<b>PSKNR/L</b>	16CA 16	2600-M6x18	2725-M5x6	AAL-02-2.5	2005-M8x25	AAL-07-5
<b>PSRNR/L</b>	16CA 12	2600-M6x18	2725-M5x6	AAL-02-2.5	2005-M8x25	AAL-07-5



Takım Kodu Ordering Code Bestell-Bezeichnung	Stok Stock Lager	Ölçü Aralığı (mm) Boring Range (mm) Bohrbereich (mm)					Kartuşlar Cartridge Kurzdrehhalter	Gövde Takım Kodu Body Tool Code Grundkörper-Bezeichnung	Teknik Çizim Technical Draw Technische Zeichnung
		D max		D min		Max (D dış-D iç) (D out-D in)			
		D iç D in	D dış D out	D iç D in	D dış D out				
ACPBT-1	●	27-52	52	18-36	36	27	ÖTG-K-120-20		
ACPBT-2	●	27-49	52	25-36	36	27			
ACPBT-3	●	48-75	75	41	42	27			
ACPBT-4	●	51-75	75	51	52	27			
ACPBT-5	●	22-35	35	22	23	27			
ACPBT-6	●	15-35	35	15	16	27			
ACPBT-7	●	49-53	75	32-36	36	27			
ACPBT-8	●	49	75	33-37	37	27			

Takım Kodu Ordering Code Bestell-Bezeichnung	Stok Stock Lager	Ölçü Aralığı (mm) Boring Range (mm) Bohrbereich (mm)					Kartuşlar Cartridge Kurzdrehhalter	Gövde Takım Kodu Body Tool Code Grundkörper-Bezeichnung	Teknik Çizim Technical Draw Technische Zeichnung
		D1		D2		Max (D dış-D iç) (D out-D in)			
		D max	D min	D max	D min				
ACPBT-9	●	38	24	15	1	-	ÖTG-K-120-20		
ACPBT-10	●	78	64	43	29	-			

R: Sağ / Right / Rechts L: Sol / Left / Links

● Stokta / In Stock / Auf Lager ○ Stokta Yok / Non Stock Item / Kein Lagerartikel, Lieferzeit auf Anfrage

Sipariş Örneği / Ordering Example / Bestellbeispiel

1 ad./pcs./stück ACPBT-1



*konusulan  
the spoken kalite...  
quality...*

# DİŞ AÇMA

DİŞ AÇMA TAKIMLARI  
THREADING TOOLHOLDERS  
GEWINDE DREHHALTER







**S** **E** **R** **25 25** **M** **16** **C**

**1** Sıkma Tipi / Method of Mounting of Insert  
 Klemmsystem  
 S: Vida Sıkmalı  
 S: Screw Clamping / S Schrauben-Spannsystem  
 T: Vida Sıkmalı Helis Açılı  
 T: Screw Clamping with Helix Angle  
 T: Schraubenklemmung für unterschiedliche Einstellwinkel

**2** İşlem Tipi / Application  
 Anwendung  
 E: Dış / External  
 Außen  
 I: İç/Internal / Internal  
 Innen

**3** Kesme Yönü  
 Cutting Direction  
 Halterausführung  
 R: Sağ Yan  
 Right-Hand  
 R: Rechts  
 L: Sol Yan  
 Left-Hand  
 L: Links

**4** Takım Malzemesi / Type of Boring / Art der Bohrstange  
 "A" Yekpare çelik gövde soğutma suyu kanallı / "A" Solid steel with coolant hole  
 "A" Stahlschaft mit Kühlbohrung SEITE 123  
 "E" Çelik başlıkla sert metal gövde ve soğutma suyu kanallı / "E" Carbide bar with fixed steel head and coolant hole  
 "E" Hartmetallstange mit festem Stahlkopf und Kühlmittelbohrung  
 "C" Karbür Şaft / "C" Carbide shank / "C" Hartmetallschaft  
 "S" Çelik Şaft / "S" Steel shank / "S" Stahlschaft

**4-5** Dış Çap Şaft Ölçüleri  
 External Shank Siz  
 Äußere Schaftgröße  
 Şaft / Shank / Schaftausführung: hxb  
 2525 - 25 x 25 mm

**5** Şaft Çapı / Shank Diameter  
 Schaft-Durchmesser

**6** Şaft Boyu / Shank Length / Schaftlänge

			(mm)
A - 32	H - 100	Q - 180	x-special
B - 40	J - 110	R - 200	
C - 50	K - 125	S - 250	
D - 60	L - 140	T - 300	
E - 70	M - 150	U - 350	
F - 80	N - 160	V - 400	
G - 90	P - 170	W - 450	

**7** Elmas Ölçüsü / Insert Size  
 Wendeplattengröße

l (mm)	d
06	5/32"
08	3/16"
11	1/4"
16	3/8"
22	1/2"
27	5/8"

**8** Baskı Pabucu  
 Wedge Clamp  
 Spannpratze

**S** **I** **R** **S** **25** **R** **16** **C**

**DIŞ ÇAP DIŞ AÇMA KATERLERİ**  
**EXTERNAL THREADING TOOLHOLDERS**  
**INNEN-GEWINDEDREHHALTER**

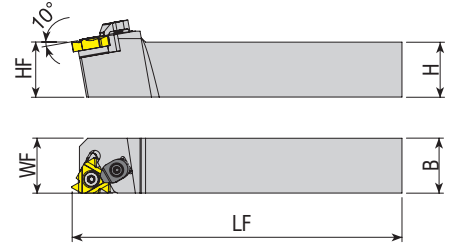
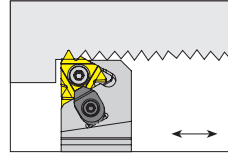

Takım Kodu Ordering Code Bestell-Bezeichnung	Stok Stock Lager		Takım Ölçüleri (mm) Dimension (mm) Abmessung (mm)				Kesici Uç Insert Wendeschneidplatte	Yedek Parçaları / Spare Parts / Ersatzteile					
	R	L	HF=H	B	LF	WF		Sıkma Vidası Screw Schraube	Altlık Shim Unterlage	Altlık Vidası Shim Screw Schraube für Unterlage	Baskı Parçası Wedge Clamp Spannpratze	Baskı Vidası Clamp Screw Klemmschraube	Tork Anahtar Torx Key Torx-Schlüssel
SER/L 0808 E11	●	●	08	08	70	11	11 ER/EL	4008-M2.5x6	-	-	-	-	80-T08
SER/L 1010 E11	●	●	10	10	70	11							
SER/L 1212 F11	●	●	12	12	80	12							
SER/L 1616 H11	●	●	16	16	100	16							
SER/L 2020 H11	●	●	20	20	100	20							
SER/L 1616 H16C	●	●	16	16	100	16	16 ER/EL (0.35 - 3) ISO METRIC	4015-M3.5x14	AATN-2-0020	AAV-06-M3.5x11	ACK-05	4015 M4x11	80-T15
SER/L 2020 K16C	●	●	20	20	125	20							
SER/L 2525 M16C	●	●	25	25	150	25							
SER/L 3232 P16C	●	●	32	32	170	32	22 ER/EL (3.5 - 4.5) ISO METRIC	1020-M4.5x16	AATN-2-0004	AAV-07-M4.5x13	ACK-05	4015 M4x11	80-T20
SER/L 2525 M22C	●	●	25	25	150	25							
SER/L 3232 P22C	●	●	32	32	170	32	16 ER/L (1.5-3 TR)	4015-M3.5x14	-	-	-	-	80-T15
SER/L 4040 S22C	●	●	40	40	250	40							
SER/L 2525 M16C-T	●	●	25	25	150	25	22 ER/L (4-6 TR)	1020-M4.5x16	-	-	-	-	80-T20
SER/L 2020 K16C-S	●	●	20	20	125	25	SNDVK 166 ER/L16	4015-M3.5x14	AATN-2-0020	AAV-06-M3.5x11	-	-	80-T15
SER/L 2525 M16C-S	●	●	25	25	150	31							
SER/L 3232 P16C-S	●	●	32	32	170	38.5							

**DIŞ ÇAP DIŞ AÇMA İSVİÇRE TİPİ KAYAR OTOMAT MAKİNA KATERLERİ**  
**EXTERNAL THREADING TOOLHOLDERS FOR SWISS TYPE SLIDING AUTOMATIC LATHES**  
**AUSSEN-GEWINDEDREHHALTER FÜR LANGDREHAUTOMATEN**

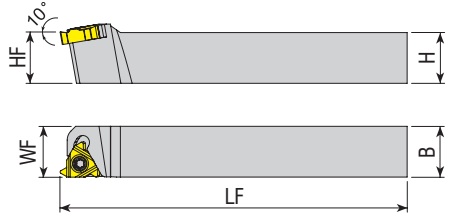
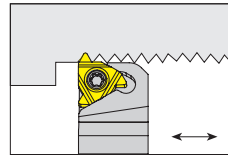

Takım Kodu Ordering Code Bestell-Bezeichnung	Stok Stock Lager		Takım Ölçüleri (mm) Dimension (mm) Abmessung (mm)				Kesici Uç Insert Wendeschneidplatte	Yedek Parçaları / Spare Parts / Ersatzteile					
	R	L	HF=H	B	LF	WF		Sıkma Vidası Screw Schraube	Altlık Shim Unterlage	Altlık Vidası Shim Screw Schraube für Unterlage	Baskı Parçası Wedge Clamp Spannpratze	Baskı Vidası Clamp Screw Klemmschraube	Tork Anahtar Torx Key Torx-Schlüssel
SER/L 1010 K11-S	●	●	10	10	125	10	11 ER/EL	4008-M2.5x6	-	-	-	-	80-T08
SER/L 1212 K11-S	●	●	12	12	125	12							

R: Sağ / Right / Rechts L: Sol/Left/Links ● Stokta / In Stock / Auf Lager ○ Stokta Yok / Non Stock Item / Kein Lagerartikel, Lieferzeit auf Anfrage

Takımlar standart 1.5° helis açılı olarak üretilir. / The tools have a built in 1.5° helix angle. / GEWINDE-DREHHALTER werden mit Einstellwinkel 1.5° hergestellt

UYARI / WARNING / ACHTUNG: Sayfa 130'deki B ve D figürleri uygulanamaz. / The operation for B and D on page 130 can not be applied. / S. 130: für Abbildung B und D: nicht verwenden

Sipariş Örneği/Ordering Example/Bestellbeispiel

1 ad./pcs./stück SER 0808 E11



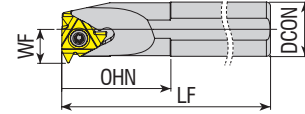
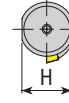
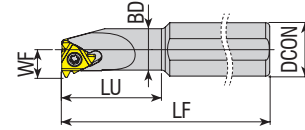
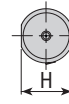
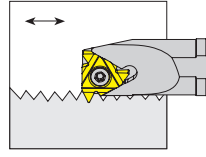

**Takım Kodu**  
**Ordering Code**  
**Bestell-Bezeichnung**

Stok Stock Lager	Takım Ölçüleri (mm) Dimension (mm) Abmessung (mm)							Kesici Uç Insert Wendeschneidplatte	Yedek Parçaları / Spare Parts / Ersatzteile						
	R	L	DCON	BD	LF	LU=OHN	WF		DMIN	Sıkma Vidası Screw Schraube	Altlık Shim Unterlage	Altlık Vidası Shim Screw Schraube für Unterlage	Baskı Parçası Wedge Clamp Spannpratze	Baskı Vidası Clamp Screw Klemmschraube	Tork Anahtar Torx Key Torx-Schlüssel
● ○			12	05	100	15	4.3	6.4	06 IR/L	3006-M2x3.6	-	-	-	-	80-T06
○ ●			16	05	100	15	4.3	6.4							
● ●			16	07	150	18	5.3	7.8	08 IR/L	3007-M2.2x5	-	-	-	-	80-T07
● ●			10	10	100	-	7.4	12	11 IR/L	4008-M2.5x6	-	-	-	-	80-T08
● ●			12	12	125	-	8.4	16							
● ●			16	10	150	25	7.4	12							
● ●			16	13	150	32	8.9	15							
● ●			16	16	150	-	11.7	19							
● ●			16	13	150	32	10.2	16	16 IR/L (0.35 - 3) ISO METRIC	4015-M3.5x9	-	-	-	-	80-T15
● ●			16	16	150	-	11.7	19							
● ●			20	16	170	40	11.7	19							
● ●			20	20	170	-	13.7	24							
● ●			25	25	200	-	16.2	29							
● ●			32	32	250	-	19.7	36							
● ●			40	40	300	-	23.7	44							
● ●			50	50	350	-	28.7	54							
● ●			20	20	170	-	15.7	24							
● ●			25	25	200	-	18.1	29							
● ●			32	32	250	-	21.6	38	22 IR/L (3.5 - 4.5) ISO METRIC	1020-M4.5x16	AATN-2-0004	AAV-07-M4.5x13	ACK-05	4015-M4x11	80-T20
● ●			40	40	300	-	25.6	46							
● ●			50	50	350	-	30.6	58	16 IR/L (1.5-3 TR)	4015-M3.5x14	-	-	-	-	80-T15
● ●			25	25	200	-	16.2	29							
● ●			32	32	250	-	19.7	36							
● ●			25	25	200	-	18.1	29	22 IR/L (4-6 TR)	1020-M4.5x16	-	-	-	-	80-T20
● ●			32	32	250	-	21.6	38							

R: Sağ / Right / Rechts L: Sol/Left/Links ● Stokta / In Stock / Auf Lager ○ Stokta Yok / Non Stock Item / Kein Lagerartikel, Lieferzeit auf Anfrage  
Takımlar standart 1.5° helis açılı olarak üretilir. / The tools have a built in 1.5° helix angle. / GEWINDE-DREHHALTER werden mit Einstellwinkel 1.5° hergestellt  
UYARI / WARNING / ACHTUNG: Sayfa 131'deki B ve D figürleri uygulanamaz. / The operation for B and D on page 131 can not be applied. / S.131: für Abbildung B und D: nicht verwenden

Sipariş Örneği/Ordering Example/Bestellbeispiel  
1 ad./pcs./stück SIR S12X05H 06

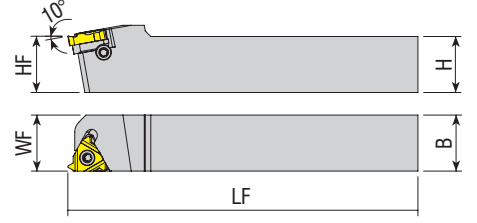
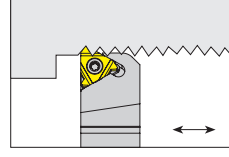
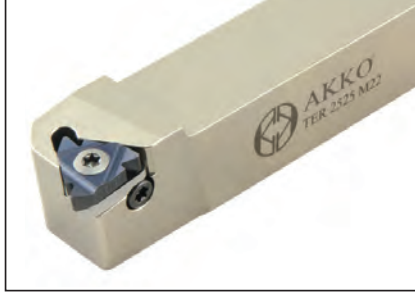

Takım Kodu Ordering Code Bestell-Bezeichnung	Stok Stock Lager		Takım Ölçüleri (mm) Dimension (mm) Abmessung (mm)				Kesici Uç Insert Wendeschneidplatte	Yedek Parçaları / Spare Parts / Ersatzteile					
	R	L	HF=H	B	LF	WF		Sıkma Vidası Screw Schraube	Sağ Altlık Right Shim U-Platte für WSP rechts	Sol Altlık Left Shim U-Platte für WSP links	Altık Vidası Shim Screw Schraube für Unterlage	Altık Vidası Pulu Shim Screw Ring Schraube für Unterlagering	Tork Anahtar Torx Key Torx-Schlüssel
TER/L 1616 H16	●	●	16	16	100	16	16 ER/EL	1710-U5-40x12.2	ATS-16E	ATS-16I	AAV-11-U5-40x4.5	ABPL-03	80-T10
TER/L 2020 K16	●	●	20	20	125	20							
TER/L 2525 M16	●	●	25	25	150	25							
TER/L 3232 P16	●	●	32	32	170	32							
TER/L 2525 M22	●	●	25	25	150	25	22 ER/EL	1720-U8-32x15	ATS-22E	ATS-22I	AAV-12-U8-32x5.5	ABPL-04	80-T20
TER/L 3232 P22	●	●	32	32	170	32							
TER/L 4040 S22	●	●	40	40	250	40							
TER/L 2525 M27	●	●	25	25	150	25	27 ER/EL	1620-M5x22	ATS-27E	ATS-27I	AAV-15-M5x5.7	ABPL-05	80-T20
TER/L 3232 P27	●	●	32	32	170	32							
TER/L 4040 S27	●	●	40	40	250	40							

R: Sağ / Right / Rechts L: Sol/Left/Links ● Stokta / In Stock / Auf Lager ○ Stokta Yok / Non Stock Item / Kein Lagerartikel, Lieferzeit auf Anfrage  
Takımlar standart 1.5° helis açılı olarak üretilir. / The tools have a built in 1.5° helix angle. / GEWINDE-DREHHALTER werden mit Einstellwinkel 1.5° hergestellt

Sipariş Örneği/Ordering Example/Bestellbeispiel  
1 ad./pcs./stück TER 1616 H16

DIŞ ÇAP SAĞ YÖNDE VIDA AÇMA  
EXTERNAL RIGHT HAND THREADING OPERATION  
HERSTELLUNG VON AUßEN-RECHTSGEWINDE

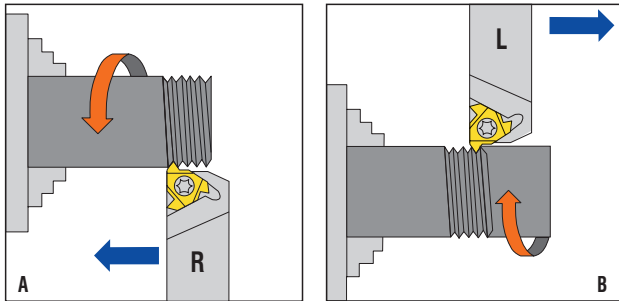

DIŞ ÇAP SOL YÖNDE VIDA AÇMA  
EXTERNAL LEFT HAND THREADING OPERATION  
HERSTELLUNG VON AUßEN-LINKSGEWINDE

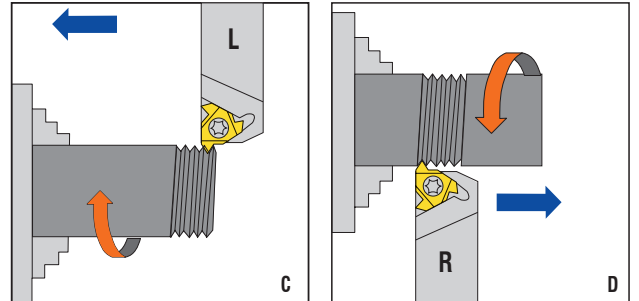

UYARI / WARNING / ACHTUNG

Figür B ve D için; negatif açılı altlık kullanılmalıdır. / For figure B and D; negative shim must be used. / Für Abbildung B und D; negative Unterlage verwenden.

Altiksız katerlerde B ve D figürü uygulanamaz. / B and D figures can not be applied on tools without shim. / Für Abbildung B und D; kann nicht mit Werkzeugen ohne Unterlegplatte erfolgen.



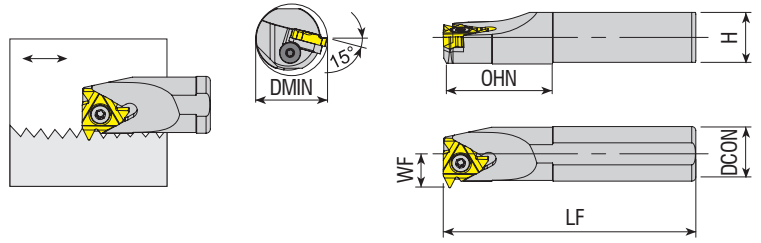

Takım Kodu Ordering Code Bestell-Bezeichnung	Stok Stock Lager		Takım Ölçüleri (mm) Dimension (mm) Abmessung (mm)					Kesici Uç Insert Wendeschneidplatte	Yedek Parçaları / Spare Parts / Ersatzteile						
	R	L	DCON	WF	LF	OHN	WF		DMIN	Sıkma Vidası Screw Schraube	Sol Altlık Left Shim U-Platte für WSP links	Sağ Altlık Right Shim U-Platte für WSP rechts	Altlık Vidası Shim Screw Schraube für Unterlage	Altlık Vidası Pulu Shim Screw Ring Schraube für Unterlagerung	Tork Anahtar Torx Key Torx-Schlüssel
TIR/L S25R 16	●	●	25	25	200	-	16.2	29	16 IR/L	1710-U5-40x12.2	ATS-16E	ATS-16I	AAV-11-U5-40x4.5	ABPL-03	80-T10
TIR/L S32S 16	●	●	32	32	250	-	19.7	36							
TIR/L S40T 16	●	●	40	40	300	-	23.7	44							
TIR/L S50U 16	●	●	50	50	350	-	28.7	54							
TIR/L S25R 22	●	●	25	25	200	-	18.1	29	22 IR/L	1720-U8-32x15	ATS-22E	ATS-22I	AAV-12-U8-32x5.5	ABPL-04	80-T20
TIR/L S32S 22	●	●	32	32	250	-	21.6	38							
TIR/L S40T 22	●	●	40	40	300	-	25.6	46							
TIR/L S50U 22	●	●	50	50	350	-	30.6	58							
TIR/L S32S 27	●	●	32	32	250	-	22.6	40	27 IR/L	1620-M5x18	ATS-27E	ATS-27I	AAV-15-M5x5.7	ABPL-05	80-T20
TIR/L S40T 27	●	●	40	40	300	-	26.6	48		1620-M5x22					
TIR/L S50U 27	●	●	50	50	350	-	31.6	58							
TIR/L A25R 16	○	●	25	25	200	50	16.2	29	16 IR/L	1710-U5-40x12.2	ATS-16E	ATS-16I	AAV-11-U5-40x4.5	ABPL-03	80-T10
TIR/L A32S 16	○	●	32	32	250	60	19.7	36							
TIR/L A40T 16	○	●	40	40	300	65	23.9	44							

R: Sağ / Right / Rechts L: Sol/Left/Links ● Stokta / In Stock / Auf Lager ○ Stokta Yok / Non Stock Item / Kein Lagerartikel, Lieferzeit auf Anfrage  
Takımlar standart 1.5° helis açılı olarak üretilir. / The tools have a built in 1.5° helix angle. / GEWINDE-DREHHALTER werden mit Einstellwinkel 1.5° hergestellt

Sipariş Örneği/Ordering Example/Bestellbeispiel  
1 ad./pcs./stück TIR S25R 16

DELİK İÇİ SAĞ YÖNDE VİDA AÇMA  
INTERNAL RIGHT HAND THREADING OPERATION  
HERSTELLUNG VON INNEN-RECHTSGEWİNDE

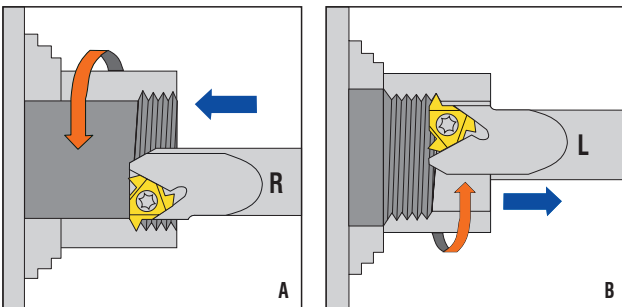

DELİK İÇİ SOL YÖNDE VİDA AÇMA  
INTERNAL LEFT HAND THREADING OPERATION  
HERSTELLUNG VON INNEN-LINKSGEWİNDE

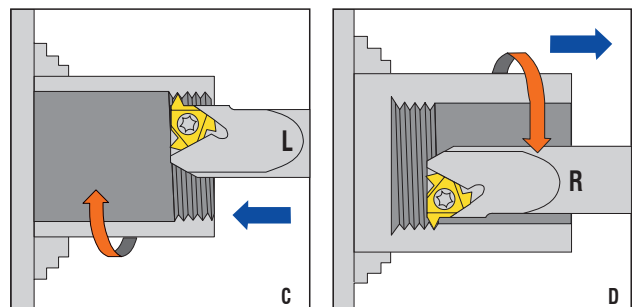

UYARI / WARNING / ACHTUNG

Figür B ve D için; negatif açılı altlık kullanılmalıdır. / For figure B and D; negative shim must be used. / Für Abbildung B und D; negative Unterlage verwenden.  
Altlıksız katerlerde B ve D figürü uygulanamaz. / B and D figures can not be applied on tools without shim. / Für Abbildung B und D; kann nicht mit Werkzeugen ohne Unterlegplatte erfolgen.

## Diş Helis Açısı Thread Helix Angle Steigungswinkel

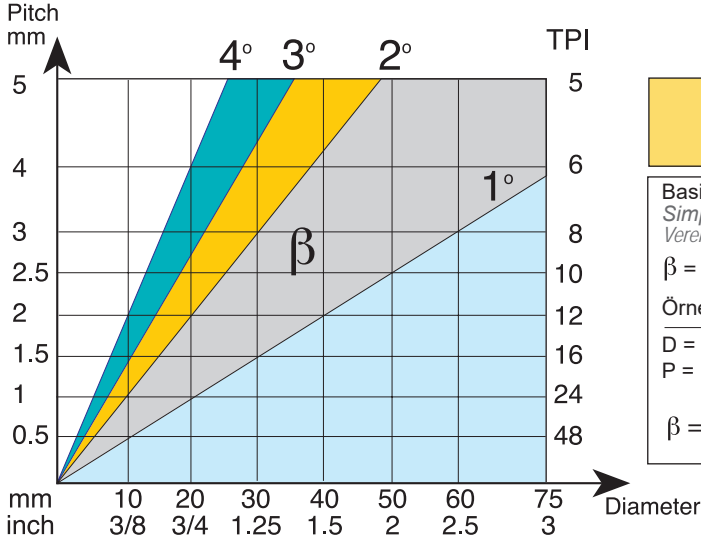

$$\tan \beta = \frac{P}{\pi \times D}$$

Basitleştirilmiş formül  
 Simplified formula  
 Vereinfachte Formel

$$\beta = 20 P/D$$

Örnek / Example / Beispiel :

$$D = 25 \text{ mm (0.98")}$$

$$P = 1.5 \text{ mm (16 TPI)}$$

$$\beta = \frac{25 \times 1.5}{40} = 1.25^\circ$$

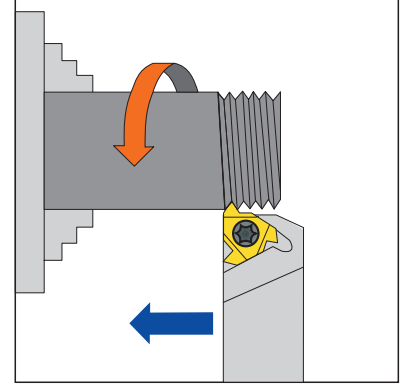

## Standart ve Eğik Altlıklar Standard and Slanted Shim Standard und Schräge Unterlegplatte

Akko diş açma takımlarının, uç yuvaları 1.5° helis açılı olarak üretilir. Farklı helis açılı diş açmak isteyenler altlığı değiştirerek istedikleri dereceyi elde edebilirler. Negatif helis genellikle sol katerde sağ diş çekmek için kullanılır ya da sağ katerde sol diş çekmek için kullanılır.

Akko Toolholders Pockets have a built in 1.5° helix angle. This angle may be adjusted to better match the thread helix angle by simply changing the shim. Negative helix is usually used when threading RH thread with LH Holder or LH thread with RH Holder.

Die Akko-Gewindedrehhalter werden mit 1,5°-Steigungswinkel produziert. Durch Wechseln der Unterlage kann dieser Winkel dem optimalen Steigungswinkel angepasst werden. Die Unterlagen mit negativem Winkel werden eingesetzt, wenn ein Rechtsgewinde mit einem linken Halter oder ein Linksgewinde mit einem rechten Halter gefertigt werden soll.

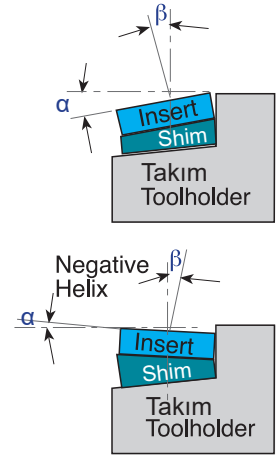

L	IC	Takım Tipi Tool Type Werkzeugtyp	Uç Yuvasının Açısı (α) / Pocket's Angle (α) / Winkel Wendeplattensitz (α)						
			4.5°	3.5°	2.5°	1.5°	0.5°	-0.5°	-1.5°
16	3/8	EX-RH or IN-LH	ATS-16E+4.5	ATS-16E+3.5	ATS-16E+2.5	ATS-16E	ATS-16E+0.5	ATS-16E-0.5	ATS-16E-1.5
16	3/8	EX-LH or IN-RH	ATS-16I+4.5	ATS-16I+3.5	ATS-16I+2.5	ATS-16I	ATS-16I+0.5	ATS-16I-0.5	ATS-16I-1.5
22	1/2	EX-RH or IN-LH	ATS-22E+4.5	ATS-22E+3.5	ATS-22E+2.5	ATS-22E	ATS-22E+0.5	ATS-22E-0.5	ATS-22E-1.5
22	1/2	EX-LH or IN-RH	ATS-22I+4.5	ATS-22I+3.5	ATS-22I+2.5	ATS-22I	ATS-22I+0.5	ATS-22I-0.5	ATS-22I-1.5
27	5/8	EX-RH or IN-LH	ATS-27E+4.5	ATS-27E+3.5	ATS-27E+2.5	ATS-27E	ATS-27E+0.5	ATS-27E-0.5	ATS-27E-1.5
27	5/8	EX-LH or IN-RH	ATS-27I+4.5	ATS-27I+3.5	ATS-27I+2.5	ATS-27I	ATS-27I+0.5	ATS-27I-0.5	ATS-27I-1.5

## Altlık Değişirme Öneri Tablosu / Shim Change Recommendation Empfehlungen zum Wechseln der Unterlage

Tabloda da görüldüğü gibi bazı diş hatvelerinin çaplara göre kombinasyonları altlık değişimini gerektirir. Eğer değişim gerekli ise EX-RH ve IN-LH katerleri için ATS-E altlıklarını, IN-RH ve EX-LH katerleri için ATS-I altlıklarını kullanın.

As can be seen from the chart, some Pitch to Diameter combinations require a shim change. If change is required, use ATS-E shim for EX-RH and IN-LH toolholders and ATS-I shims for IN-RH and EX-LH toolholders.

Wie aus der Tabelle ersichtlich, erfordern einige Steigung-Durchmesser-Kombinationen einen Wechsel der Unterlage. In diesem Fall wird eine ATS-E-Unterlage auf einem rechten Außenhalter bzw. einem linken Innenhalter eingesetzt. Die ATS-I-Unterlage kommt bei einem rechten Innenhalter bzw. einem linken Außenhalter zum Einsatz.

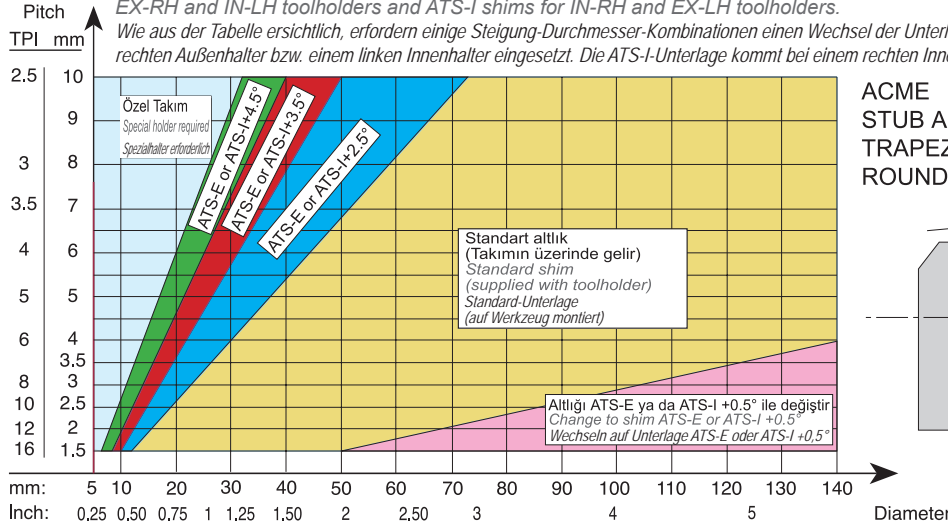

ACME  
 STUB ACME  
 TRAPEZ (DIN 103)  
 ROUND (DIN 405)

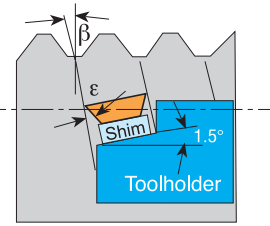

Tabloda da görüldüğü gibi çoğu uygulamalar altlık değişimine ihtiyaç duymaz. Eğer değişime ihtiyaç duyulursa EX-RH ve IN-LH katerleri için ATS-E altlıklarını, IN-RH ve EX-RH katerleri için ATS-I altlıklarını kullanın.

As can be seen from the chart, most applications do not require a shim change. If change is required, use ATS-E shims for EX-RH and IN-LH toolholders and ATS-I shims for IN-RH and EX-LH toolholders.

Wie aus der Tabelle ersichtlich, erfordern einige Steigung-Durchmesser-Kombinationen einen Wechsel der Unterlage. In diesem Fall wird eine ATS-E-Unterlage auf einem rechten Außenhalter bzw. einem linken Innenhalter eingesetzt. Die ATS-I-Unterlage kommt bei einem rechten Innenhalter bzw. einem linken Außenhalter zum Einsatz.

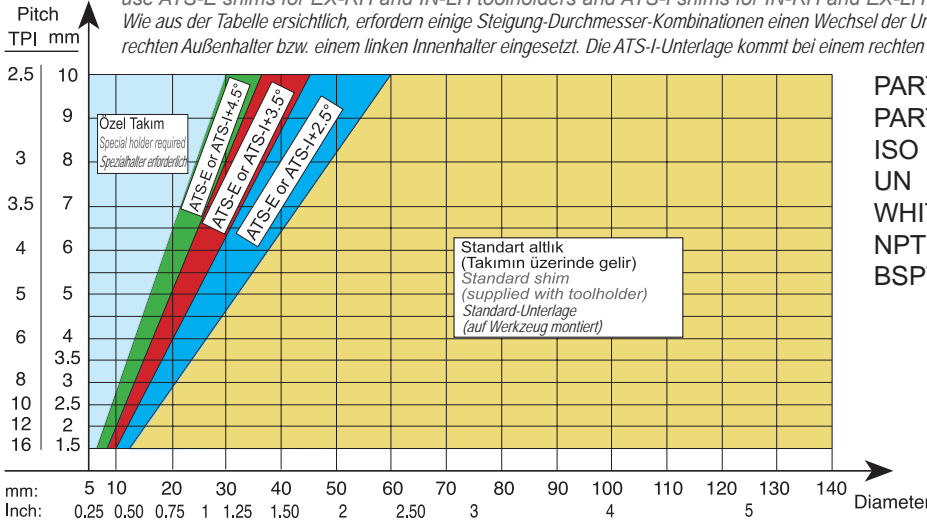

PARTIAL PROFILES 60°  
 PARTIAL PROFILES 55°  
 ISO  
 UN  
 WHIT.  
 NPT  
 BSPT

Tabloda da görüldüğü gibi çoğu uygulamalar altlık değişimine ihtiyaç duyar. Çoğu durumda negatif bir altlığa ihtiyaç duyulur. EX-RH ve IN-LH takımlar için ATS-E altlıklarını kullanın. IN-RH ve EX-LH takımlar için ATS-I altlıklarını kullanın.

As can be seen from the chart, most applications require a shim change. In most cases a negative shim is required, use ATS-E shims for EX-RH and IN-LH toolholders. ATS-I shims for IN-RH and EX-LH toolholders.

Wie aus der Tabelle ersichtlich, erfordern einige Steigung-Durchmesser-Kombinationen einen Wechsel der Unterlage. In diesem Fall wird eine ATS-E-Unterlage auf einem rechten Außenhalter bzw. einem linken Innenhalter eingesetzt. Die ATS-I-Unterlage kommt bei einem rechten Innenhalter bzw. einem linken Außenhalter zum Einsatz.

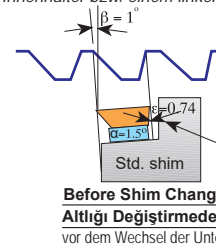
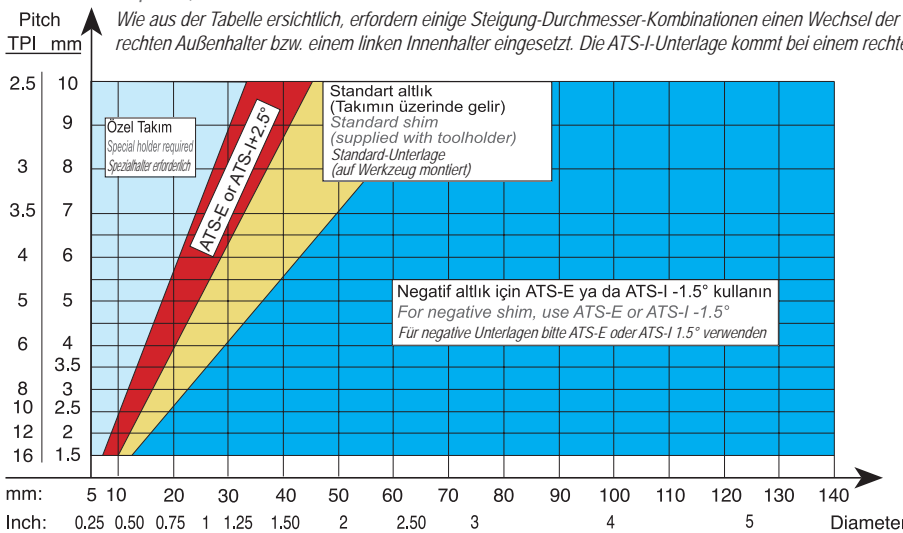

AMERICAN  
 BUTTRESS  
 SAGENGEWINDE  
 (DIN 513)

Standart altlığın negatif bir altlıkla değiştirilmesi, kenar sürtmesini engelleyecektir.

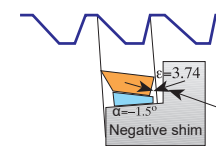

Replacing the standard shim with a shim has negative angle, will eliminate side rubbing  
 Das Ersetzen der Standard-Unterlegplatte durch eine Unterlegplatte mit negativem Winkel verhindert seitliche Reibung.



*konusulan*  
*the spoken kalite...*  
*quality...*

# KANAL AÇMA

KANAL AÇMA TAKIMLARI  
GROOVING TOOLHOLDERS  
STECHHALTER







**AKKO** **A** **AKT** - **K** - **R** - **2525**

1 2 3 4 5

**100 - 150** - **4** - **T22**

6 7 8

**2** Kesici Stili / Cutter Style / Cutter-Stil

DKT: Dış Çap Kanal Açma Takımı / External Grooving Toolholders  
Außen-Steckhalter  
IKT: Delik İçeri Kanal Açma Takımı / Internal Grooving Toolholders  
Innen-Steckhalter  
AKT: Dış Çap Alın Kanal Takımları / Face Grooving Toolholders  
Axial-Steckhalter  
LKT: L Tip Alın Kanal Açma Takımı / L Type Face Grooving Toolholders  
Axial-Steckhalter L-Type

**3** Uç Tipi / Insert Type / Plattenform

KRLY / MGM.  
HRN / S312, S229, S224, S223  
ISCR / DGN, GI, GTN  
SNDVK / 123, 151, 154.91  
ZCC  
KM / A4.  
ARN / LOMR.  
TGTC / TD.

**4** Kesme Yönü / Cutting Direction  
Halteausführung

R L

**5** Kesme Kenar Yüksekliği ve Şaft Genişliği  
Cutting Edge Height and Shank Width  
Schafthöhe und Schafbreite

H  
B  
DCON

**6** Kesme Aralığı  
Cutting Diameter  
Durchmesser für Axialeinstechen

DAXX (150)  
DAXIN (100)

**7** Kesme Kenar Genişliği / Cutting Width Edge  
Plattenbreite

ÖR/E.G. :  
2 = 2.0 mm  
3 = 3.0 mm  
4 = 4.0 mm  
5 = 5.0 mm  
6 = 6.0 mm  
8 = 8.0 mm

CW

**8** Kesme Derinliği / Cutting Depth / Maximale Schnitttiefe

CDX  
CDX

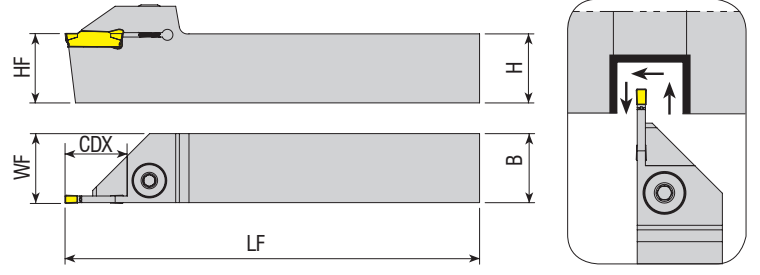

Takım Kodu Ordering Code Bestell-Bezeichnung	Stok Stock Lager		Takım Ölçüleri (mm) Dimension (mm) Abmessung (mm)				Kesici Uç Insert Wendeschneidplatte	Yedek Parçaları / Spare Parts / Ersatzteile			
	R	L	HF=H	B	LF	WF		CDX	Sıkma Vidası Screw Schraube	Pul Stamp Ring	Anahtar Allen Key Immereschlüssel
ADKT-K-R/L-1212-1.5-T15	●	●	12	12	100	12.2	15	MGM. - 1.5	AKV-02-M6x22	ABPL-01	AAL-03-3
ADKT-K-R/L-2020-1.5-T15	●	●	20	20	125	20.2	15				
ADKT-K-R/L-1212-2-T15	●	●	12	12	100	16.3	15				
ADKT-K-R/L-1616-2-T10	●	●	16	16	125	16.3	10	MGM. - 2	AKV-02-M6x22	ABPL-01	AAL-03-3
ADKT-K-R/L-1616-2-T15	●	●	16	16	125	16.3	15				
ADKT-K-R/L-2020-2-T15	●	●	20	20	150	20.3	15				
ADKT-K-R/L-2525-2-T15	●	●	25	25	150	25.3	15				
ADKT-K-R/L-3232-2-T15	●	●	32	32	170	32.3	15				
ADKT-K-R/L-1212-3-T15	●	●	12	12	100	12.3	15				
ADKT-K-R/L-1616-3-T15	●	●	16	16	125	16.3	15				
ADKT-K-R/L-2020-3-T10	●	●	20	20	125	20.3	10				
ADKT-K-R/L-2020-3-T20	●	●	20	20	125	20.3	20				
ADKT-K-R/L-2020-3-R28	●	●	20	20	125	20.3	28				
ADKT-K-R/L-2525-3-T10	●	●	25	25	150	25.3	10				
ADKT-K-R/L-2525-3-R15	●	●	25	25	150	25.3	15				
ADKT-K-R/L-2525-3-T22	●	●	25	25	150	25.3	22				
ADKT-K-R/L-3232-3-T10	●	●	32	32	170	32.3	10				
ADKT-K-R/L-3232-3-T22	●	●	32	32	170	32.3	22				
ADKT-K-R/L-2020-4-T10	●	●	20	20	125	20.4	10	MGM. - 4	2004-M8x1x20	-	AAL-05-4
ADKT-K-R/L-2020-4-T20	●	●	20	20	125	20.4	20				
ADKT-K-R/L-2020-4-R25	●	○	20	20	125	20.4	25				
ADKT-K-R/L-2525-4-T10	●	●	25	25	150	25.4	10				
ADKT-K-R/L-2525-4-T18	●	●	25	25	150	25.4	18				
ADKT-K-R/L-2525-4-T22	●	●	25	25	150	25.4	22				
ADKT-K-R/L-3232-4-T10	●	●	32	32	170	32.4	10	MGM. - 5			
ADKT-K-R/L-3232-4-T22	●	●	32	32	170	32.4	22				
ADKT-K-R/L-2020-5-T20	●	●	20	20	125	20.5	20				
ADKT-K-R/L-2525-5-T15	●	●	25	25	150	25.5	15				
ADKT-K-R/L-2525-5-T18	●	●	25	25	150	25.5	18				
ADKT-K-R/L-2525-5-T25	●	●	25	25	150	25.5	25				
ADKT-K-R/L-3232-5-T15	●	●	32	32	170	32.5	15	MGM. - 6			
ADKT-K-R/L-3232-5-T25	●	●	32	32	170	32.5	25				
ADKT-K-R/L-2525-6-T15	●	●	25	25	150	25.6	15				
ADKT-K-R/L-2525-6-T25	●	●	25	25	150	25.6	25	MGM. - 8			
ADKT-K-R/L-3232-6-T25	●	●	32	32	170	32.6	25				
ADKT-K-R/L-3232-8-T32	●	●	32	32	170	32.8	32				

R: Sağ / Right / Rechts L: Sol/Left/Links

● Stokta / In Stock / Auf Lager ○ Stokta Yok / Non Stock Item / Kein Lagerartikel, Lieferzeit auf Anfrage

KRLY - JD Uçuna Uygun. / Compatible with KRLY - JD Insert. / Kompatibel mit KRLY - JD Wendeplatten

Sipariş Örneği/Ordering Example/Bestellbeispiel

1 ad./pcs./stück ADKT-K-R-1212-1.5-T15

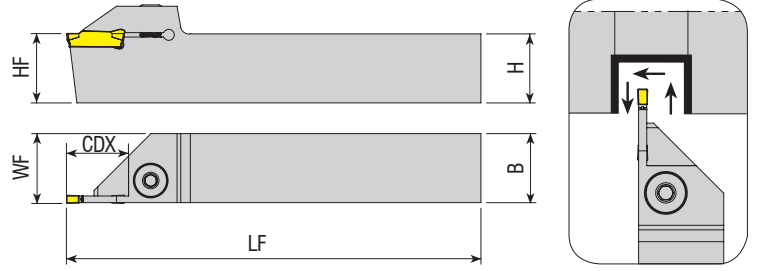

Takım Kodu Ordering Code Bestell-Bezeichnung	Stok Stock Lager		Takım Ölçüleri (mm) Dimension (mm) Abmessung (mm)					Kesici Uç Insert Wendeschneidplatte	Yedek Parçaları / Spare Parts / Ersatzteile		
	R	L	HF=H	B	LF	WF	CDX		Sıkma Vidası Screw Schraube	Pul Stamp Ring	Anahtar Allen Key Immerdrehschlüssel
ADKT-KG-R/L-2020-2-T15	●	●	20	20	125	20.2	15	KG.. - 2	AKV-02-M6x22	ABPL-01	AAL-03-3
ADKT-KG-R/L-2525-2-T8	●	●	25	25	150	25.2	8				
ADKT-KG-R/L-2525-2-T15	●	○	25	25	150	25.2	15				
ADKT-KG-R/L-2525-2-T17	●	○	25	25	150	25.2	17	KG.. - 3			
ADKT-KG-R/L-1616-3-T20	●	●	16	16	125	16.3	20				
ADKT-KG-R/L-2020-3-T20	●	●	20	20	125	20.3	20				
ADKT-KG-R/L-2525-3-T10	●	●	25	25	150	25.3	10				
ADKT-KG-R/L-2525-3-T13	●	●	25	25	150	25.3	13				
ADKT-KG-R/L-2525-3-T22	●	●	25	25	150	25.3	22				
ADKT-KG-R/L-2020-4-T20	●	●	20	20	125	20.4	20	KG.. - 4	2004-M8x1x20	-	AAL-05-4
ADKT-KG-R/L-2525-4-T10	●	●	25	25	150	25.4	10				
ADKT-KG-R/L-2525-4-T16	●	○	25	25	150	25.4	16				
ADKT-KG-R/L-2525-4-T22	●	○	25	25	150	25.4	22				
ADKT-KG-R/L-2525-5-T12	●	●	25	25	150	25.5	12	KG.. - 5			
ADKT-KG-R/L-2525-5-T15	●	●	25	25	150	25.5	15				
ADKT-KG-R/L-2525-5-T25	●	○	25	25	150	25.5	25	KG.. - 6			
ADKT-KG-R/L-2525-6-T25	○	○	25	25	150	25.6	25				

R: Sağ / Right / Rechts L: Sol/Left/Links  
● Stokta / In Stock / Auf Lager ○ Stokta Yok / Non Stock Item / Kein Lagerartikel, Lieferzeit auf Anfrage  
KRLY Ucuna Uygun. / Compatiple with KRLY Insert. / Kompatibel mit KRLY Wendepplatten

Sipariş Örneği/Ordering Example/Bestellbeispiel  
1 ad./pcs./stück ADKT-KG-R-2020-2-T15



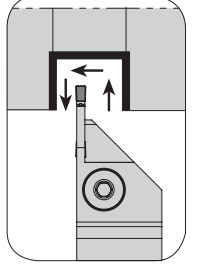
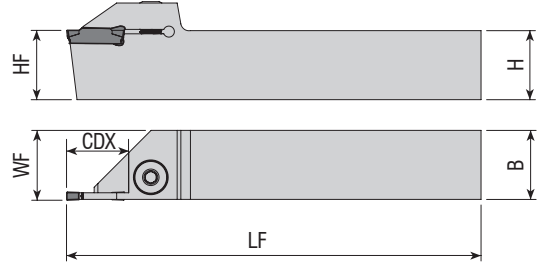

Takım Kodu Ordering Code Bestell-Bezeichnung	Stok Stock Lager		Takım Ölçüleri (mm) Dimension (mm) Abmessung (mm)					Kesici Uç Insert Wendeschneidplatte	Yedek Parçaları / Spare Parts / Ersatzteile			
	R	L	HF=H	B	LF	WF	CDX		Sıkma Vidası Screw Schraube	Pul Stamp Ring	Anahtar Allen Key Innerschraubenschlüssel	
ADKT-SGC-R/L-1212-2-R15	●	●	12	12	100	16.2	15	GCM N20	AKV-02-M6x22	ABPL-01	AAL-03-3	
ADKT-SGC-R/L-1616-2-R15	●	●	16	16	125	16.2	15					
ADKT-SGC-R/L-2020-2-R20	●	●	20	20	125	20.2	20					
ADKT-SGC-R/L-2525-2-R20	●	●	25	25	150	25.2	20					
ADKT-SGC-R/L-1212-3-R15	●	●	12	12	100	16.3	15	GCM N30	2004-M8x1x20	-	AAL-05-4	
ADKT-SGC-R/L-1616-3-R15	●	●	16	16	125	16.3	15					
ADKT-SGC-R/L-2020-3-R22	●	●	20	20	125	20.3	22					
ADKT-SGC-R/L-2525-3-R15	●	○	25	25	150	25.3	15					
ADKT-SGC-R/L-2525-3-R22	●	●	25	25	150	25.3	22					
ADKT-SGC-R/L-2525-4-R25	●	○	25	25	150	25.4	25	GCM N40				

SMTM Ucuna Uygunur. / Compatible with SMTM Insert. / Kompatibel mit SMTM Wendeplatten

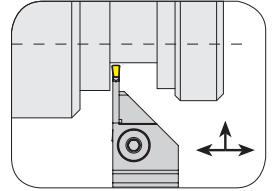
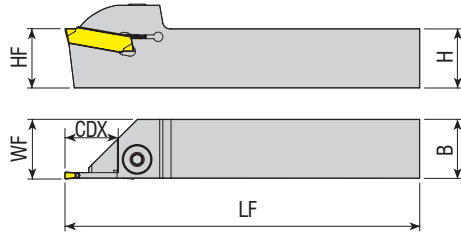

Takım Kodu Ordering Code Bestell-Bezeichnung	Stok Stock Lager		Takım Ölçüleri (mm) Dimension (mm) Abmessung (mm)					Kesici Uç Insert Wendeschneidplatte	Yedek Parçaları / Spare Parts / Ersatzteile			
	R	L	HF=H	B	LF	WF	CDX		Sıkma Vidası Screw Schraube	Pul Stamp Ring	Anahtar Allen Key Innerschraubenschlüssel	
ADKT-H-R/L-2020-3-T20	●	●	20	20	125	20.5	20	S229 - 3				
ADKT-H-R/L-2525-3-T22	●	●	25	25	150	25.5	22					
ADKT-H-R/L-2525-3-T26	●	●	25	25	150	25.5	26					
ADKT-H-R/L-2020-4-T20	●	●	20	20	125	20.5	20	S229 - 4	2004-M8x1x20	-	AAL-05-4	
ADKT-H-R/L-2525-4-T22	●	●	25	25	150	25.5	22					
ADKT-H-R/L-3232-4-T22	●	●	32	32	170	32.5	22	S229 - 5				
ADKT-H-R/L-2020-5-T20	●	●	20	20	125	20.5	20					
ADKT-H-R/L-2525-5-T25	●	●	25	25	150	25.5	25					
ADKT-H-R/L-2525-6-T25	●	●	25	25	150	25.6	25	S229 - 6				

R: Sağ / Right / Rechts L: Sol/Left/Links

● Stokta / In Stock / Auf Lager ○ Stokta Yok / Non Stock Item / Kein Lagerartikel, Lieferzeit auf Anfrage  
HRN Ucuna Uygunur. / Compatible with HRN Insert. / Kompatibel mit HRN Wendeplatten.

Sipariş Örneği/Ordering Example/Bestellbeispiel  
1 ad./pcs./stück ADKT-SGC-R-1212-2-R15



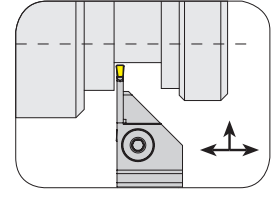
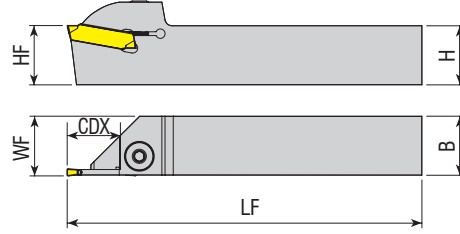

Takım Kodu Ordering Code Bestell-Bezeichnung	Stok Stock Lager		Takım Ölçüleri (mm) Dimension (mm) Abmessung (mm)				Kesici Uç Insert Wendeschneidplatte	Yedek Parçaları / Spare Parts / Ersatzteile			
	R	L	HF=H	B	LF	WF		CDX	Sıkma Vidası Screw Schraube	Pul Stamp Ring	Anahtar Allen Key Innerschlüsselschlüssel
ADKT-HK-R/L-1616-2-T15	●	●	16	16	125	16.3	15	S224 - 2	AKV-02-M6x22	ABPL-01	AAL-03-3
ADKT-HK-R/L-2020-2-T15	●	●	20	20	125	20.3	15				
ADKT-HK-R/L-2525-2-T15	●	●	25	25	150	25.3	15	S224 - 3	2004-M8x1x20	-	AAL-05-4
ADKT-HK-R/L-1616-3-T15	○	○	16	16	125	16.3	15				
ADKT-HK-R/L-2020-3-T20	●	●	20	20	125	20.4	20	S224 - 4	2004-M8x1x20	-	AAL-05-4
ADKT-HK-R/L-2525-3-T22	●	●	25	25	150	25.4	22				
ADKT-HK-R/L-2020-4-T20	●	●	20	20	125	20.4	20	S223 - 2	AKV-02-M6x22	ABPL-01	AAL-03-3
ADKT-HK-R/L-2525-4-T22	●	●	25	25	150	25.4	22				
ADKT-HS223-R/L-2020-2-T15	●	○	20	20	125	20.4	15	S223 - 2	AKV-02-M6x22	ABPL-01	AAL-03-3
ADKT-HS223-R/L-2020-3-T17	●	○	20	20	125	20.3	17	S223 - 3	2004-M8x1x20	-	AAL-05-4

HRN Ucuna Uygundur. / Compatible with HRN Insert. / Kompatibel mit HRN Wendepfatten.

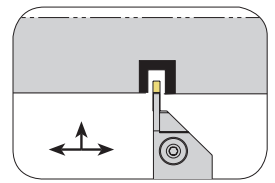
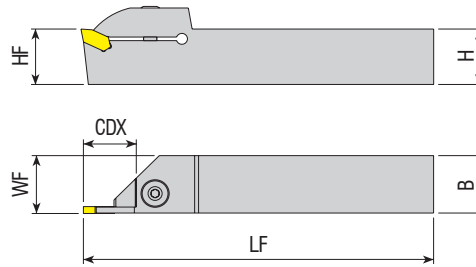

Takım Kodu Ordering Code Bestell-Bezeichnung	Stok Stock Lager		Takım Ölçüleri (mm) Dimension (mm) Abmessung (mm)				Kesici Uç Insert Wendeschneidplatte	Yedek Parçaları / Spare Parts / Ersatzteile			
	R	L	HF=H	B	LF	WF		CDX	Sıkma Vidası Screw Schraube	Pul Stamp Ring	Anahtar Allen Key Innerschlüsselschlüssel
ADKT-ZCC1-R/L-2020-3-T20	●	○	20	20	125	20.3	20	ZQMX - 3	2004-M8x1x20	-	AAL-05-4
ADKT-ZCC1-R/L-2525-3-T22	●	○	25	25	150	25.3	22				
ADKT-ZCC1-R/L-2020-4-T20	●	○	20	20	125	20.4	20	ZQMX - 4	2004-M8x1x20	-	AAL-05-4
ADKT-ZCC1-R/L-2525-4-T22	●	○	25	25	150	25.4	22				

R: Sağ / Right / Rechts L: Sol/Left/Links

● Stokta / In Stock / Auf Lager ○ Stokta Yok / Non Stock Item / Kein Lagerartikel, Lieferzeit auf Anfrage  
ZCC Ucuna Uygundur. / Compatible with ZCC Insert. / Kompatibel mit ZCC Wendepfatten.

Sipariş Örneği/Ordering Example/Bestellbeispiel  
1 ad./pcs./stück ADKT-HK-R-1616-2-T15

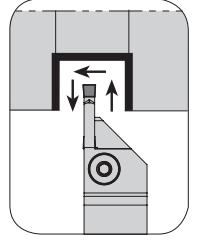
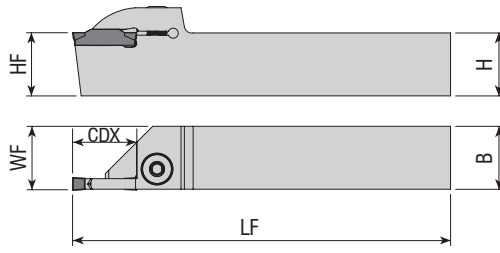

Takım Kodu Ordering Code Bestell-Bezeichnung	Stok Stock Lager		Takım Ölçüleri (mm) Dimension (mm) Abmessung (mm)					Kesici Uç Insert Wendeschneidplatte	Yedek Parçaları / Spare Parts / Ersatzteile			
	R	L	HF=H	B	LF	WF	CDX		Sıkma Vidası Screw Schraube	Pul Stamp Ring	Anahtar Allen Key Innerschraubenschlüssel	
ADKT-ZCC2-R/L-1616-2-T15	●	●	16	16	125	16.2	15	Z.BD - 2	AKV-02-M6x22	ABPL-01	AAL-03-3	
ADKT-ZCC2-R/L-2020-2-T7	●	●	20	20	125	20.2	7					
ADKT-ZCC2-R/L-2020-2-T15	●	●	20	20	125	20.2	15					
ADKT-ZCC2-R/L-2525-2-T15	●	●	25	25	150	25.2	15	Z.ED - 2.5				
ADKT-ZCC2-R/L-1616-2.5-T15	●	●	16	16	125	16.3	15					
ADKT-ZCC2-R/L-2020-2.5-T17	●	●	20	20	125	20.3	17					
ADKT-ZCC2-R/L-2525-2.5-T15	●	●	25	25	150	25.3	15	Z.FD - 3				
ADKT-ZCC2-R/L-1616-3-T15	●	●	16	16	125	16.3	15					
ADKT-ZCC2-R/L-1616-3-T17	●	○	16	16	125	16.3	17					
ADKT-ZCC2-R/L-1616-3-T20	●	○	16	16	125	16.3	20	Z.GD - 4	2004-M8x1x20	-	AAL-05-4	
ADKT-ZCC2-R/L-2020-3-T12	●	●	20	20	125	20.3	12					
ADKT-ZCC2-R/L-2020-3-T20	●	●	20	20	125	20.3	20					
ADKT-ZCC2-R/L-2020-3-R21	●	○	20	20	125	20.3	21	Z.HD - 5				
ADKT-ZCC2-R/L-2020-3-R25	●	●	20	20	125	20.3	25					
ADKT-ZCC2-R/L-2525-3-T12	●	○	25	25	150	25.3	12					
ADKT-ZCC2-R/L-2525-3-T22	●	●	25	25	150	25.3	22	Z.KD - 6				
ADKT-ZCC2-R/L-2525-3-R30	●	●	25	25	150	25.3	30					
ADKT-ZCC2-R/L-2020-4-T12	●	○	20	20	125	20.5	12					
ADKT-ZCC2-R/L-2020-4-T20	●	●	20	20	125	20.5	20	Z.HD - 5				
ADKT-ZCC2-R/L-2525-4-T12	●	●	25	25	150	25.5	12					
ADKT-ZCC2-R/L-2525-4-T22	●	●	25	25	150	25.5	22					
ADKT-ZCC2-R/L-2020-5-T12	●	○	20	20	125	20.5	12	Z.HD - 5				
ADKT-ZCC2-R/L-2020-5-T20	●	●	20	20	125	20.5	20					
ADKT-ZCC2-R/L-2525-5-T12	●	○	25	25	150	25.5	12					
ADKT-ZCC2-R/L-2525-5-T25	●	●	25	25	150	25.5	25	Z.KD - 6				
ADKT-ZCC2-R/L-3232-5-T25	●	●	32	32	170	32.5	25					
ADKT-ZCC2-R/L-2020-6-T20	●	●	20	20	125	20.6	20					
ADKT-ZCC2-R/L-2525-6-T25	●	●	25	25	150	25.6	25	Z.KD - 6				
ADKT-ZCC2-R/L-3232-6-T25	●	●	32	32	170	32.6	25					
ADKT-ZCC2-R/L-3232-6-T30	●	●	32	32	170	32.6	30					

R: Sağ / Right / Rechts L: Sol/Left/Links  
● Stokta / In Stock / Auf Lager ○ Stokta Yok / Non Stock Item / Kein Lagerartikel, Lieferzeit auf Anfrage  
ZCC Ucuna Uygunudur. / Compatiple with ZCC Insert. / Kompatibel mit ZCC Wendeplatten.

Sipariş Örneği/Ordering Example/Bestellbeispiel  
1 ad./pcs./stück ADKT-ZCC2-R-1616-2-T15

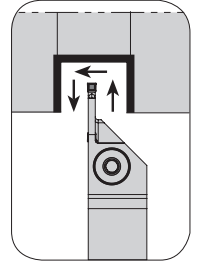
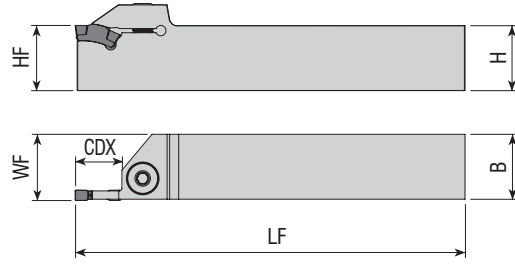

**Takım Kodu**  
**Ordering Code**  
**Bestell-Bezeichnung**

Takım Kodu Ordering Code Bestell-Bezeichnung	Stok Stock Lager		Takım Ölçüleri (mm) Dimension (mm) Abmessung (mm)				Kesici Uç Insert Wendeschneidplatte	Yedek Parçaları / Spare Parts / Ersatzteile			
	R	L	HF=H	B	LF	WF		CDX	Sıkma Vidası Screw Schraube	Pul Stamp Ring	Anahtar Allen Key Innerschraubschlüssel
ADKT-ITG-R/L-2020-3-T8	●	●	20	20	125	20.3	8	TGM. - 3	2004-M8x1x20	-	AAL-05-4
ADKT-ITG-R/L-2525-3-T8	●	●	25	25	150	25.3	8				
ADKT-ITG-R/L-3232-3-T8	●	○	32	32	170	32.3	8				
ADKT-ITG-R/L-2020-4-T9	●	●	20	20	125	20.4	9	TGM. - 4	2004-M8x1x20	-	AAL-05-4
ADKT-ITG-R/L-2525-4-T17	●	●	25	25	150	25.4	17				
ADKT-ITG-R/L-3232-4-T17	●	●	32	32	170	32.4	17				
ADKT-ITG-R/L-3232-5-T25	●	○	32	32	170	32.5	25	TGM. - 5	2004-M8x1x20	-	AAL-05-4

ISCR Ucuna Uygun. / Compatible with ISCR Insert. / Kompatibel mit ISCR Wendeplatten.

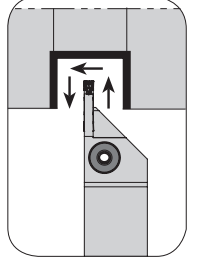
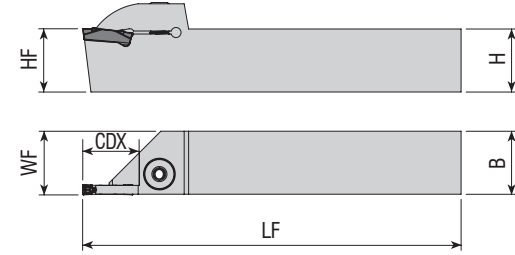
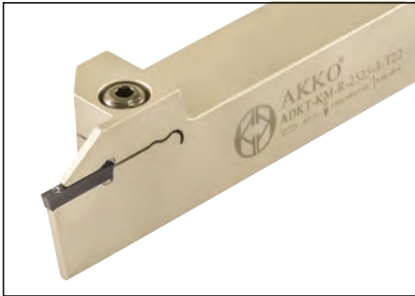

**Takım Kodu**  
**Ordering Code**  
**Bestell-Bezeichnung**

Takım Kodu Ordering Code Bestell-Bezeichnung	Stok Stock Lager		Takım Ölçüleri (mm) Dimension (mm) Abmessung (mm)				Kesici Uç Insert Wendeschneidplatte	Yedek Parçaları / Spare Parts / Ersatzteile			
	R	L	HF=H	B	LF	WF		CDX	Sıkma Vidası Screw Schraube	Pul Stamp Ring	Anahtar Allen Key Innerschraubschlüssel
ADKT-KM-R/L-2020-2-T15	●	●	20	20	125	20.3	15	A4. - 2	AKV-02-M6x22	ABPL-01	AAL-03-3
ADKT-KM-R/L-2525-2-T15	●	●	25	25	150	25.3	15	A4. - 2	AKV-02-M6x22	ABPL-01	AAL-03-3
ADKT-KM-R/L-2020-3-T20	●	●	20	20	125	20.4	20	A4. - 3	2004-M8x1x20	-	AAL-05-4
ADKT-KM-R/L-2525-3-T22	●	●	25	25	150	25.4	22	A4. - 3	2004-M8x1x20	-	AAL-05-4
ADKT-KM-R/L-2525-4-T22	●	●	25	25	150	25.5	22	A4. - 4	2004-M8x1x20	-	AAL-05-4

R: Sağ / Right / Rechts L: Sol/Left/Links

● Stokta / In Stock / Auf Lager ○ Stokta Yok / Non Stock Item / Kein Lagerartikel, Lieferzeit auf Anfrage

KNMTL Ucuna Uygun. / Compatible with KNMTL Insert. / Kompatibel mit KNMTL Wendeplatten.

Sipariş Örneği/Ordering Example/Bestellbeispiel

1 ad./pcs./stück ADKT-ITG-R-2020-3-T8

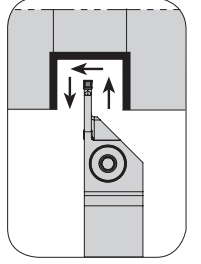
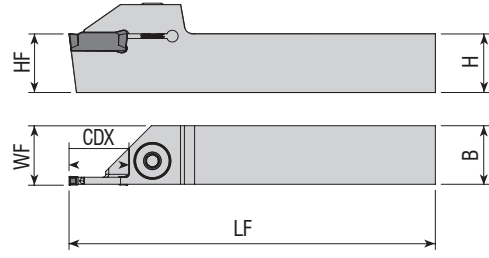

Takım Kodu Ordering Code Bestell-Bezeichnung	Stok Stock Lager		Takım Ölçüleri (mm) Dimension (mm) Abmessung (mm)				Kesici Uç Insert Wendeschneidplatte	Yedek Parçaları / Spare Parts / Ersatzteile			
	R	L	HF=H	B	LF	WF		CDX	Sıkma Vidası Screw Schraube	Pul Stamp Ring	Anahtar Allen Key Innenzweischlüssel
ADKT-I-R/L-1212-2-T15	●	●	12	12	125	16.3	15	DGN - 2	AKV-02-M6x22	ABPL-01	AAL-03-3
ADKT-I-R/L-1616-2-T15	●	●	16	16	100	16.3	15				
ADKT-I-R/L-2020-2-T15	●	●	20	20	125	20.3	15				
ADKT-I-R/L-2525-2-T15	●	●	25	25	150	25.3	15				
ADKT-I-R/L-3232-2-T15	●	●	32	32	170	32.3	15	DGN - 3			
ADKT-I-R/L-1212-3-T15	●	●	12	12	100	16.3	15				
ADKT-I-R/L-1616-3-T15	●	●	16	16	125	16.3	15				
ADKT-I-R/L-2020-3-T12	●	●	20	20	125	20.3	12				
ADKT-I-R/L-2020-3-T20	●	●	20	20	125	20.3	20				
ADKT-I-R/L-2525-3-T12	●	●	25	25	150	25.3	12				
ADKT-I-R/L-2525-3-T22	●	●	25	25	150	25.3	22				
ADKT-I-R/L-3232-3-T22	●	●	32	32	170	32.3	22				
ADKT-I-R/L-2020-4-T20	●	●	20	20	125	20.4	20	DGN / GRP - 4	2004-M8x1x20	-	AAL-05-4
ADKT-I-R/L-2525-4-T12	●	●	25	25	150	25.4	12				
ADKT-I-R/L-2525-4-T22	●	●	25	25	150	25.4	22				
ADKT-I-R/L-3232-4-T25	●	●	32	32	170	32.4	25				
ADKT-I-R/L-2020-5-T20	●	●	20	20	125	20.5	20	DGN / GRP - 5			
ADKT-I-R/L-2525-5-T12	●	●	25	25	150	25.5	12				
ADKT-I-R/L-2525-5-T25	●	●	25	25	150	25.5	25	GRP - 3			
ADKT-IG-R/L-1616-3-T18	●	○	16	16	125	16.3	18				
ADKT-IG-R/L-2020-3-T12	●	●	20	20	125	20.3	12				
ADKT-IG-R/L-2020-3-R20	●	●	20	20	125	20.3	20				
ADKT-IG-R/L-2525-3-T12	●	●	25	25	150	25.3	12				
ADKT-IG-R/L-2525-3-T22	●	●	25	25	150	25.3	22				
ADKT-IGI-R/L-2020-2-T15	●	●	20	20	125	20.3	15	GIM / GIP - 2	AKV-02-M6x22	ABPL-01	AAL-03-3
ADKT-IGI-R/L-2525-2-T15	●	●	25	25	150	25.3	15				
ADKT-IGI-R/L-1616-3-T15	●	●	16	16	125	16.3	15	GIM / GIP - 3			
ADKT-IGI-R/L-2020-3-T20	●	●	20	20	125	20.3	20				
ADKT-IGI-R/L-2525-3-T19	●	●	25	25	150	25.3	9				
ADKT-IGI-R/L-2525-3-T22	●	●	25	25	150	25.3	22				
ADKT-IGI-R/L-2525-4-T22	●	●	25	25	150	25.4	22	GIM / GIP - 4	2004-M8x1x20	-	AAL-05-4
ADKT-IGI-R/L-2525-5-T25	●	●	25	25	150	25.5	25	GIM / GIP - 5			
ADKT-IGI-R/L-2525-8-T30	●	○	25	25	150	25.8	30	GIM / GIP - 8			
ADKT-IGTN-R/L-2525-5-T25	●	●	25	25	150	25.6	25	GTN - 5			
ADKT-IDC-R/L-2525-3-T21	●	○	25	25	150	25.4	21	DCE - 3			

R: Sağ / Right / Rechts L: Sol/Left/Links

● Stokta / In Stock / Auf Lager ○ Stokta Yok / Non Stock Item / Kein Lagerartikel, Lieferzeit auf Anfrage  
ISCR Ucuna Uygunudur. / Compatible with ISCR Insert. / Kompatibel mit ISCR Wendeplatten.

Sipariş Örneği/Ordering Example/Bestellbeispiel  
1 ad./pcs./stück ADKT-I-R-1212-2-T15



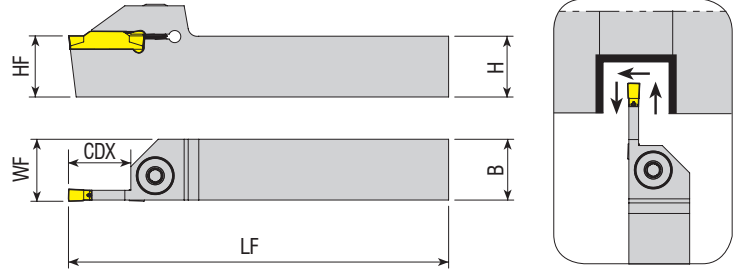

**Takım Kodu**  
**Ordering Code**  
**Bestell-Bezeichnung**

Stok Stock Lager		Takım Ölçüleri (mm) Dimension (mm) Abmessung (mm)						Kesici Uç Insert Wendeschneidplatte	Yedek Parçaları / Spare Parts / Ersatzteile		
		R	L	HF=H	B	LF	WF		CDX	Sıkma Vidası Screw Schraube	Pul Stamp Ring
ADKT-123-R/L-1212-1.5-R15	●	●	12	12	100	12.2	15	123 - 1.5	AKV-02-M6x22	ABPL-01	AAL-03-3
ADKT-123-R/L-1616-1.5-R15	●	●	16	16	125	16.2	15				
ADKT-123-R/L-1616-2-T15	●	●	16	16	125	16.2	15				
ADKT-123-R/L-2020-2-T8	●	○	20	20	125	20.2	8				
ADKT-123-R/L-2020-2-T15	●	●	20	20	125	20.2	15				
ADKT-123-R/L-2525-2-T8	●	●	25	25	150	25.2	8				
ADKT-123-R/L-2525-2-T15	●	●	25	25	150	25.2	15				
ADKT-123-R/L-3232-2-T15	●	●	32	32	170	32.2	15				
ADKT-123-R-1616-3-T10	●	●	16	16	125	16.3	10	123 - 3	2004-M8x1x20	-	AAL-05-4
ADKT-123-R/L-1616-3-T15	●	●	16	16	125	16.3	15				
ADKT-123-R-2020-3-T10	●	●	20	20	125	20.3	10				
ADKT-123-R-2020-3-T15	●	●	20	20	125	20.3	15				
ADKT-123-R/L-2020-3-T20	●	●	20	20	125	20.3	20				
ADKT-123-R-2525-3-T10	●	●	25	25	150	25.3	10				
ADKT-123-R-2525-3-T15	●	●	25	25	150	25.3	15				
ADKT-123-R/L-2525-3-T22	●	●	25	25	150	25.3	22				
ADKT-123-R/L-2020-4-T20	●	●	20	20	125	20.4	20	123 - 4			
ADKT-123-R-2525-4-T13	●	●	25	25	150	25.4	13				
ADKT-123-R/L-2525-4-T22	●	●	25	25	150	25.4	22				
ADKT-123-R/L-3232-4-T25	●	●	32	32	170	32.4	25				
ADKT-123-R/L-2020-5-T20	●	●	20	20	125	20.5	20	123 - 5			
ADKT-123-R/L-2525-5-T25	●	●	25	25	150	25.5	25				
ADKT-123-R/L-3232-6-T15	●	●	32	32	170	32.5	15	123 - 6			

R: Sağ / Right / Rechts L: Sol/Left/Links

● Stokta / In Stock / Auf Lager ○ Stokta Yok / Non Stock Item / Kein Lagerartikel, Lieferzeit auf Anfrage  
SNDVK Ucuna Uygundur. / Compatible with SNDVK Insert. / Kompatibel mit SNDVK Wendeplatten.

Sipariş Örneği/Ordering Example/Bestellbeispiel  
1 ad./pcs./stück ADKT-123-R-1212-1.5-R15

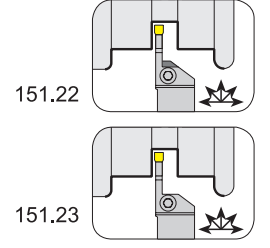
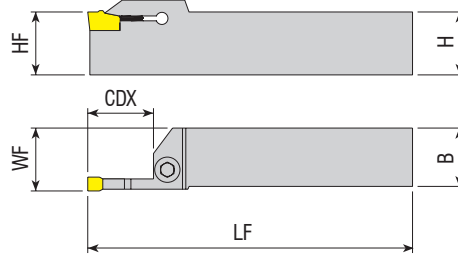

Takım Kodu Ordering Code Bestell-Bezeichnung	Stok Stock Lager		Takım Ölçüleri (mm) Dimension (mm) Abmessung (mm)				Kesici Uç Insert Wendeschneidplatte	Yedek Parçaları / Spare Parts / Ersatzteile			
	R	L	HF=H	B	LF	WF		CDX	Sıkma Vidası Screw Schraube	Pul Stamp Ring	Anahtar Allen Key Innerschlüsselschlüssel
ADKT-151.22-R/L-1616-2-T15	●	●	16	16	125	16.3	15	151.2 - 2	AKV-02-M6x22	ABPL-01	AAL-03-3
ADKT-151.22-R/L-2020-2-T15	●	●	20	20	125	20.3	15				
ADKT-151.22-R/L-2525-2-T15	●	●	25	25	150	25.3	15	151.2 - 3	2004-M8x1x20	-	AAL-05-4
ADKT-151.22-R/L-1616-3-T15	●	●	16	16	125	16.4	15				
ADKT-151.22-R/L-2020-3-T20	●	●	20	20	125	20.4	20	151.2 - 4	2004-M8x1x20	-	AAL-05-4
ADKT-151.22-R/L-2525-3-T22	●	●	25	25	150	25.4	22				
ADKT-151.22-R/L-1616-4-T15	●	●	16	16	125	16.4	15	151.2 - 5	2004-M8x1x20	-	AAL-05-4
ADKT-151.22-R/L-2020-4-T20	●	●	20	20	125	20.4	20				
ADKT-151.22-R/L-2525-4-T22	●	●	25	25	150	25.4	22	151.2 - 2	AKV-02-M6x22	ABPL-01	AAL-03-3
ADKT-151.22-R/L-2020-5-T20	●	●	20	20	125	20.5	20				
ADKT-151.22-R/L-2525-5-T25	●	●	25	25	150	25.5	25	151.2 - 2.5	2004-M8x1x20	-	AAL-05-4
ADKT-151.23-R/L-1616-2-T15	●	●	16	16	125	16.3	15				
ADKT-151.23-R/L-2020-2-T15	●	●	20	20	125	20.3	15	151.2 - 3	2004-M8x1x20	-	AAL-05-4
ADKT-151.23-R/L-2525-2-T15	●	●	25	25	150	25.3	15				
ADKT-151.23-R/L-1616-2.5-T15	●	●	16	16	125	16.3	15	151.2 - 4	2004-M8x1x20	-	AAL-05-4
ADKT-151.23-R/L-2020-2.5-T15	●	●	20	20	125	20.3	15				
ADKT-151.23-R/L-2525-2.5-T15	●	●	25	25	150	25.3	15	151.2 - 5	2004-M8x1x20	-	AAL-05-4
ADKT-151.23-R/L-1212-3-T15	●	●	12	12	100	16.4	15				
ADKT-151.23-R/L-1616-3-T15	●	●	16	16	125	16.4	15	151.2 - 4	2004-M8x1x20	-	AAL-05-4
ADKT-151.23-R/L-2020-3-T20	●	●	20	20	125	20.4	20				
ADKT-151.23-R/L-2525-3-T20	●	●	25	25	150	25.4	20	151.2 - 5	2004-M8x1x20	-	AAL-05-4
ADKT-151.23-R/L-2525-3-T22	●	●	25	25	150	25.4	22				
ADKT-151.23-R/L-1616-4-T15	●	●	16	16	125	16.4	15	151.2 - 4	2004-M8x1x20	-	AAL-05-4
ADKT-151.23-R/L-2020-4-T20	●	●	20	20	125	20.4	20				
ADKT-151.23-R/L-2525-4-T22	●	●	25	25	150	25.4	22	151.2 - 5	2004-M8x1x20	-	AAL-05-4
ADKT-151.23-R/L-2020-5-T20	●	●	20	20	125	20.5	20				
ADKT-151.23-R/L-2525-5-T25	●	●	25	25	150	25.5	25				

R: Sağ / Right / Rechts L: Sol/Left/Links  
● Stokta / In Stock / Auf Lager ○ Stokta Yok / Non Stock Item / Kein Lagerartikel, Lieferzeit auf Anfrage  
SNDVK Ucuna Uygundur. / Compatible with SNDVK Insert. / Kompatibel mit SNDVK Wendeplatten.

Sipariş Örneği/Ordering Example/Bestellbeispiel  
1 ad./pcs./stück ADKT-151.22-R-1616-2-T15

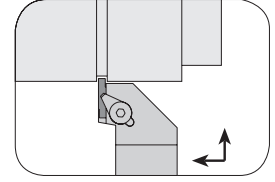
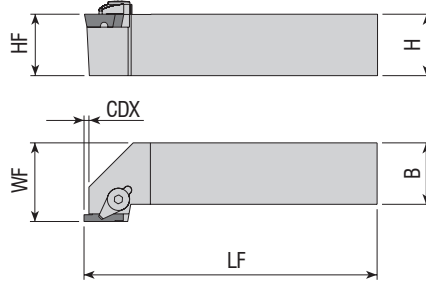

**Takım Kodu**  
**Ordering Code**  
**Bestell-Bezeichnung**

Stok Stock Lager	Takım Ölçüleri (mm) Dimension (mm) Abmessung (mm)							Kesici Uç Insert Wendeschneidplatte	Yedek Parçaları / Spare Parts / Ersatzteile				
	R	L	HF=H	B	LF	WF	CDX		Baskı Parçası Wedge Clamp Spannspratze	Sıkma Vidası Screw Schraube	Pul Stamp Ring	Anahtar Allen Key Innerschlüsselschlüssel	
●	●	20	20	125	25	4		154.91 - 3	ACK-03	AKV-07-M6x22	APM-06	AAL-03-3	
●	●	25	25	150	30.5	4							
●	●	20	20	125	25	5		154.91 - 5	ACK-03	AKV-07-M6x22	APM-06	AAL-03-3	
●	●	25	25	150	30.5	5							

SNDVK Ucuna Uygunur. / Compatiple with SNDVK Insert. / Kompatibel mit SNDVK Wendeschneidplatten.

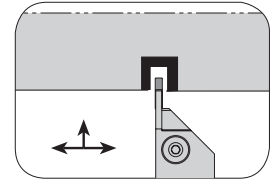
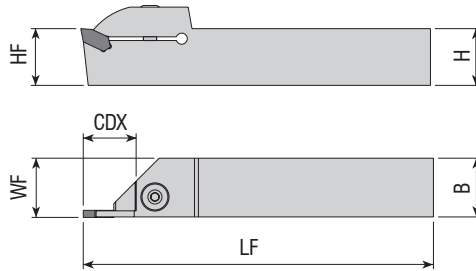

**Takım Kodu**  
**Ordering Code**  
**Bestell-Bezeichnung**

Stok Stock Lager	Takım Ölçüleri (mm) Dimension (mm) Abmessung (mm)							Kesici Uç Insert Wendeschneidplatte	Yedek Parçaları / Spare Parts / Ersatzteile			
	R	L	HF=H	B	LF	WF	CDX		Sıkma Vidası Screw Schraube	Pul Stamp Ring	Anahtar Allen Key Innerschlüsselschlüssel	
●	●	20	20	125	20.3	15		LOMR. - 2	AKV-02-M6x22	ABPL-01	AAL-03-3	
●	●	25	25	150	25.3	15						
●	●	20	20	125	20.4	20		LOMR. - 3	2004-M8x1x20	-	AAL-05-4	
●	●	25	25	150	25.4	22						

R: Sağ / Right / Rechts L: Sol/Left/Links

● Stokta / In Stock / Auf Lager ○ Stokta Yok / Non Stock Item / Kein Lagerartikel, Lieferzeit auf Anfrage

ARN Ucuna Uygunur. / Compatiple with ARN Insert. / Kompatibel mit ARN Wendeschneidplatten.

Sipariş Örneği/Ordering Example/Bestellbeispiel  
1 ad./pcs./stück ADKT-154.91-R-2020-3-T4

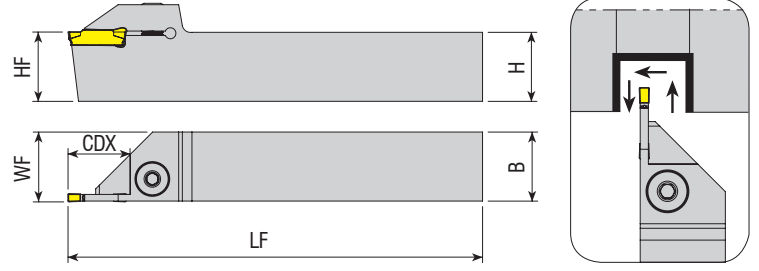

Takım Kodu Ordering Code Bestell-Bezeichnung	Stok Stock Lager		Takım Ölçüleri (mm) Dimension (mm) Abmessung (mm)					Kesici Uç Insert Wendeschneidplatte	Yedek Parçaları / Spare Parts / Ersatzteile			
	R	L	HF=H	B	LF	WF	CDX		Sıkma Vidası Screw Schraube	Pul Stamp Ring	Anahtar Allen Key Innerschraubschlüssel	
ADKT-TD-R/L-1212-2-T15	●	●	12	12	100	12.2	15	TD. - 2	AKV-02-M6x22	ABPL-01	AAL-03-3	
ADKT-TD-R/L-1616-2-T8	●	●	16	16	125	16.2	8					
ADKT-TD-R/L-1616-2-T15	●	●	16	16	125	16.2	15					
ADKT-TD-R/L-2020-2-T9	●	○	20	20	125	20.2	9					
ADKT-TD-R/L-2020-2-T15	●	●	20	20	125	20.2	15					
ADKT-TD-R/L-2020-2-T17	●	○	20	20	125	20.2	17					
ADKT-TD-R/L-2020-2-T20	●	○	20	20	125	20.2	20					
ADKT-TD-R/L-2525-2-T8	●	●	25	25	150	25.2	8					
ADKT-TD-R/L-2525-2-T17	●	●	25	25	150	25.2	17					
ADKT-TD-R/L-1212-3-T15	●	●	12	12	100	12.4	15					TD. - 3
ADKT-TD-R/L-1616-3-T15	●	●	16	16	125	16.4	15					
ADKT-TD-R/L-2020-3-T12	●	●	20	20	125	20.4	12					
ADKT-TD-R/L-2020-3-T20	●	●	20	20	125	20.4	20					
ADKT-TD-R/L-2020-3-T25	●	○	20	20	125	20.4	25					
ADKT-TD-R/L-2020-3-T30	●	●	20	20	125	20.4	30					
ADKT-TD-R/L-2525-3-T9	●	●	25	25	150	25.4	9					
ADKT-TD-R/L-2525-3-T12	●	●	25	25	150	25.4	12					
ADKT-TD-R/L-2525-3-T22	●	●	25	25	150	25.4	22					
ADKT-TD-R/L-2525-3-T25	●	●	25	25	150	25.4	25					
ADKT-TD-R/L-2525-3-T30	●	●	25	25	150	25.4	30					
ADKT-TD-R/L-3232-3-T25	●	○	32	32	170	32.4	25	TD. - 4				
ADKT-TD-R/L-2525-4-T10	●	●	25	25	150	25.5	10					
ADKT-TD-R/L-2525-4-T15	●	●	25	25	150	25.5	15					
ADKT-TD-R/L-2525-4-T22	●	●	25	25	150	25.5	22					
ADKT-TD-R/L-2525-4-T25	●	○	25	25	150	25.5	25					
ADKT-TD-R/L-2525-4-T30	●	○	25	25	150	25.5	30	TD. - 5				
ADKT-TD-R/L-2525-5-T25	●	●	25	25	150	25.5	25					

R: Sağ / Right / Rechts L: Sol/Left/Links

● Stokta / In Stock / Auf Lager ○ Stokta Yok / Non Stock Item / Kein Lagerartikel, Lieferzeit auf Anfrage

TGTC Ucuna Uygunudur. / Compatible with TGTC Insert. / Kompatibel mit TGTC Wendeplatten.

Sipariş Örneği/Ordering Example/Bestellbeispiel

1 ad./pcs./stück ADKT-TD-R-1212-2-T15



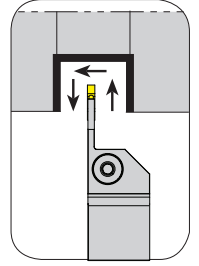
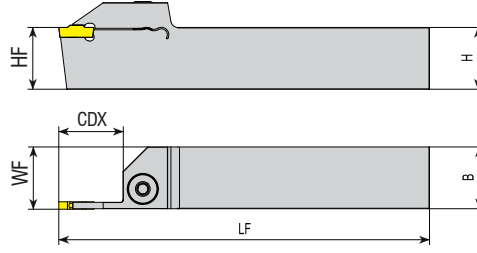

**Takım Kodu**  
**Ordering Code**  
**Bestell-Bezeichnung**

Stok Stock Lager	Takım Ölçüleri (mm) Dimension (mm) Abmessung (mm)						Kesici Uç Insert Wendeschneidplatte	Yedek Parçaları / Spare Parts / Ersatzteile			
	R	L	HF=H	B	LF	WF		Sıkma Vidası Screw Schraube	Pul Stamp Ring	Anahtar Allen Key Inmenschenschlüssel	
ADKT-RD-R/L-1616-2-T17	●	○	16	16	125	16,2	17	RD. - 2	AKV-02-M6x22	ABPL-01	AAL-03-3
ADKT-RD-R/L-2020-2-T17	●	○	20	20	125	20,2	17				
ADKT-RD-R/L-2525-2-T17	●	●	25	25	150	25,2	17				
ADKT-RD-R/L-1616-3-T20	●	○	16	16	125	16,3	20	RD. - 3	2004-M8x1x20	-	AAL-05-4
ADKT-RD-R/L-2020-3-T25	●	○	20	20	125	20,3	25				
ADKT-RD-R/L-2525-3-T25	●	●	25	25	150	25,3	25				
ADKT-RD-R/L-2020-4-T30	●	○	20	20	125	20,5	30	RD. - 4	2004-M8x1x20	-	AAL-05-4
ADKT-RD-R/L-2525-4-T30	●	●	25	25	150	25,5	30				

TGTC Ucuna Uygundur. / Compatible with TGTC Insert. / Kompatibel mit TGTC Wendepfatten.

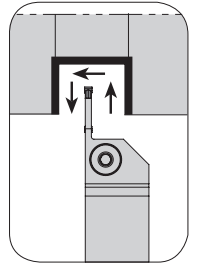
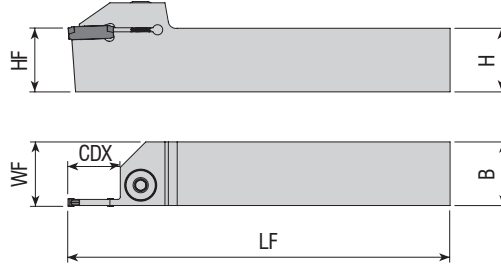

**Takım Kodu**  
**Ordering Code**  
**Bestell-Bezeichnung**

Stok Stock Lager	Takım Ölçüleri (mm) Dimension (mm) Abmessung (mm)						Kesici Uç Insert Wendeschneidplatte	Yedek Parçaları / Spare Parts / Ersatzteile			
	R	L	HF=H	B	LF	WF		Sıkma Vidası Screw Schraube	Pul Stamp Ring	Anahtar Allen Key Inmenschenschlüssel	
ADKT-LGC-R/L-1616-2-D40	●	●	16	16	125	16,2	20	GCTX - 2	AKV-02-M6x22	ABPL-01	AAL-03-3
ADKT-LGC-R/L-2020-2-D40	●	●	20	20	125	20,2	20				
ADKT-LGC-R/L-2525-2-D40	●	●	25	25	150	25,2	20				
ADKT-LGC-R/L-1616-3-T20	●	●	16	16	125	16,3	20	GCTX - 3	2004-M8x1x20	-	AAL-05-4
ADKT-LGC-R/L-2020-3-T20	●	●	20	20	125	20,3	20				
ADKT-LGC-R/L-2525-3-T20	●	●	25	25	150	25,3	20				

R: Sağ / Right / Rechts L: Sol/Left/Links  
● Stokta / In Stock / Auf Lager ○ Stokta Yok / Non Stock Item / Kein Lagerartikel, Lieferzeit auf Anfrage  
LMN Ucuna Uygundur. / Compatible with LMN Insert. / Kompatibel mit LMN Wendepfatten.

Sipariş Örneği/Ordering Example/Bestellbeispiel  
1 ad./pcs./stück ADKT-RD-R-1616-2-T17

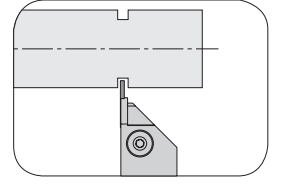
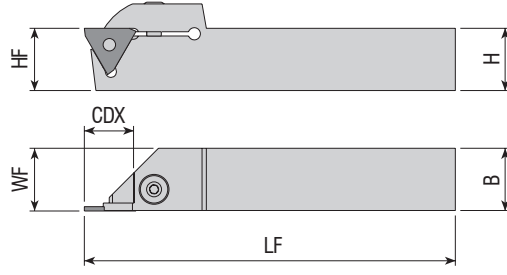

Takım Kodu Ordering Code Bestell-Bezeichnung	Stok Stock Lager		Takım Ölçüleri (mm) Dimension (mm) Abmessung (mm)				Kesici Uç Insert Wendeschneidplatte	Yedek Parçaları / Spare Parts / Ersatzteile				
	R	L	HF=H	B	LF	WF		CDX	Sıkma Vidası Screw Schraube	Baskı Pabucu Wedge Clamp Spannpratze	Sekman Ring Feder	Anahtar Allen Key Innenschlankschlüssel
ADKT-H22-R/L-1616-(0.5-2)-T4	●	●	16	16	125	16.2	4					
ADKT-H22-R/L-2020-(0.5-2)-T4	●	●	20	20	125	20.2	4	<b>S312 - (0.5-2)</b>	AKV-29-M6x29	AKK-04	AS-01	AAL-03-3
ADKT-H22-R/L-2525-(0.5-2)-T4	●	●	25	25	150	25.2	4					

HRN Ucuna Uygun. / Compatible with HRN Insert. / Kompatibel mit HRN Wendepfatten.

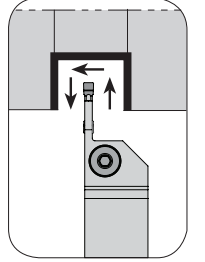
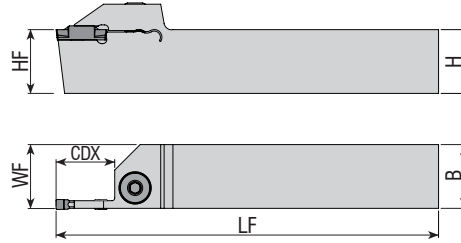
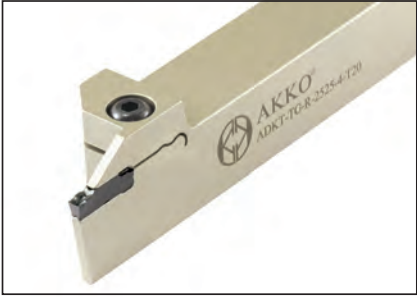

Takım Kodu Ordering Code Bestell-Bezeichnung	Stok Stock Lager		Takım Ölçüleri (mm) Dimension (mm) Abmessung (mm)				Kesici Uç Insert Wendeschneidplatte	Yedek Parçaları / Spare Parts / Ersatzteile			
	R	L	HF=H	B	LF	WF		CDX	Sıkma Vidası Screw Schraube	Pul Stamp Ring	Anahtar Allen Key Innenschlankschlüssel
ADKT-TG-R/L-1616-2-R17	●	○	16	16	125	16.2	17	<b>DGM2-020</b>	AKV-02-M6x22	ABPL-01	
ADKT-TG-R/L-2020-2-R8	●	○	20	20	125	20.2	8				
ADKT-TG-R/L-2020-2-R12	●	○	20	20	125	20.2	12				
ADKT-TG-R/L-2020-2-R17	●	○	20	20	125	20.2	17				
ADKT-TG-R/L-2525-2-R12	●	○	25	25	150	25.2	12				
ADKT-TG-R/L-2525-2-R17	●	○	25	25	150	25.2	17	<b>DGM3-020</b>	2004-M8x1x20	-	
ADKT-TG-R/L-1616-3-T20	●	○	16	16	125	16.3	20				
ADKT-TG-R/L-2020-3-T12	●	○	20	20	125	20.3	12				
ADKT-TG-R/L-2020-3-T20	●	○	20	20	125	20.3	20				
ADKT-TG-R/L-2525-3-T9	●	○	25	25	150	25.3	9				
ADKT-TG-R/L-2525-3-T20	●	○	25	25	150	25.3	20				
ADKT-TG-R/L-2525-3-R25	●	○	25	25	150	25.3	25				
ADKT-TG-R/L-2525-4-T15	●	○	25	25	150	25.5	15				
ADKT-TG-R/L-2525-4-T20	●	○	25	25	150	25.5	20				
ADKT-TG-R/L-2525-4-T25	●	○	25	25	150	25.5	25				
ADKT-TG-R/L-2525-5-T12	●	○	25	25	150	25.5	12	<b>DGM5-030</b>	2004-M8x1x20	-	
ADKT-TG-R/L-2525-5-T25	●	○	25	25	150	25.5	25				
ADKT-TG-R/L-2525-5-T32	●	○	25	25	150	25.5	32				

R: Sağ / Right / Rechts L: Sol/Left/Links

● Stokta / In Stock / Auf Lager ○ Stokta Yok / Non Stock Item / Kein Lagerartikel, Lieferzeit auf Anfrage

TNGLY Ucuna Uygun. / Compatible with TNGLY Insert. / Kompatibel mit TNGLY Wendepfatten.

Sipariş Örneği/Ordering Example/Bestellbeispiel

1 ad./pcs./stück ADKT-H22-R-1616-(0.5-2)T4



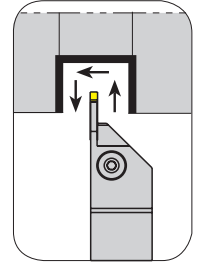
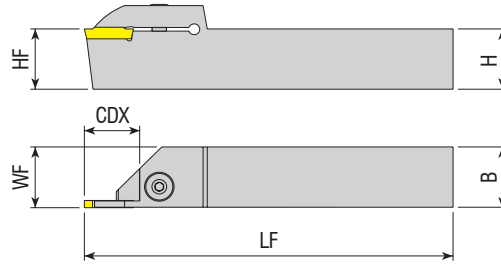

Takım Kodu Ordering Code Bestell-Bezeichnung	Stok Stock Lager		Takım Ölçüleri (mm) Dimension (mm) Abmessung (mm)				Kesici Uç Insert Wendeschneidplatte	Yedek Parçaları / Spare Parts / Ersatzteile			
	R	L	HF=H	B	LF	WF		CDX	Sıkma Vidası Screw Schraube	Pul Stamp Ring	Anahtar Allen Key Innerschraubenschlüssel
ADKT-WGX16-R/L-2020-2-R16	●	○	20	20	125	20.2	16	GX16. - 2	AKV-02-M6x22	ABPL-01	AAL-03-3
ADKT-WGX16-R/L-2525-2-R16	●	○	25	25	150	25.2	16				
ADKT-WGX24-R/L-2020-3-T20	●	●	20	20	125	20.4	20	GX24. - 3	2004-M8x1x20	-	AAL-05-4
ADKT-WGX24-R/L-2525-3-T12	●	●	25	25	150	25.4	12				
ADKT-WGX24-R/L-2525-3-T22	●	●	25	25	150	25.4	22				
ADKT-WGX24-R/L-3232-3-T22	●	○	32	32	170	32.4	22				
ADKT-WGX24-R/L-2525-4-T22	●	●	25	25	150	25.5	22				
ADKT-WGX24-R/L-2525-5-T25	●	●	25	25	150	25.5	25	GX24. - 5			
ADKT-WGX24-R/L-3232-5-T25	●	●	32	32	170	32.5	25				

WLTR Ucuna Uygun. / Compatible with WLTR Insert. / Kompatibel mit WLTR Wendeplatten.

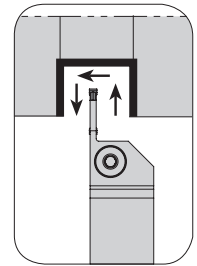
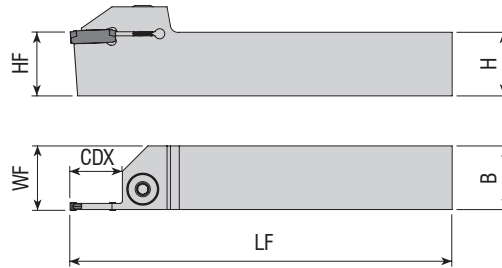

Takım Kodu Ordering Code Bestell-Bezeichnung	Stok Stock Lager		Takım Ölçüleri (mm) Dimension (mm) Abmessung (mm)				Kesici Uç Insert Wendeschneidplatte	Yedek Parçaları / Spare Parts / Ersatzteile			
	R	L	HF=H	B	LF	WF		CDX	Sıkma Vidası Screw Schraube	Pul Stamp Ring	Anahtar Allen Key Innerschraubenschlüssel
ADKT-GP-R/L-2020-2-T15	●	●	20	20	125	20.2	15	GP - 2	AKV-02-M6x22	ABPL-01	AAL-03-3
ADKT-GP-R/L-2525-2-T15	●	●	25	25	150	25.2	15				
ADKT-GP-R/L-2020-3-T20	●	●	20	20	125	20.3	20	GP - 3	2004-M8x1x20	-	AAL-05-4
ADKT-GP-R/L-2525-3-T22	●	●	25	25	150	25.3	22				
ADKT-GP-R/L-2525-4-T22	●	●	25	25	150	25.4	22				
ADKT-GP-R/L-2525-5-T25	●	●	25	25	150	25.5	25				
ADKT-GP-R/L-2525-5-T25	●	●	25	25	150	25.5	25				

R: Sağ / Right / Rechts L: Sol/Left/Links

● Stokta / In Stock / Auf Lager ○ Stokta Yok / Non Stock Item / Kein Lagerartikel, Lieferzeit auf Anfrage

PLBT Ucuna Uygun. / Compatible with PLBT Insert. / Kompatibel mit PLBT Wendeplatten.

Sipariş Örneği/Ordering Example/Bestellbeispiel



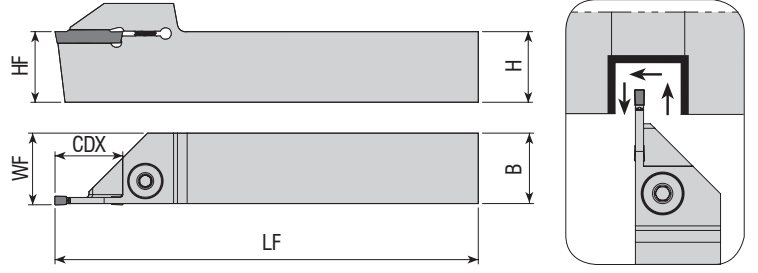

1 ad./pcs./stück ADKT-WGX16-R-2020-2-R16

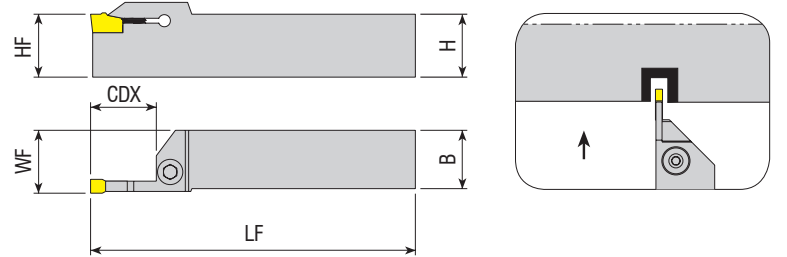

Takım Kodu Ordering Code Bestell-Bezeichnung	Stok Stock Lager		Takım Ölçüleri (mm) Dimension (mm) Abmessung (mm)				Kesici Uç Insert Wendeschneidplatte	Yedek Parçaları / Spare Parts / Ersatzteile			
	R	L	HF=H	B	LF	WF		CDX	Sıkma Vidası Screw Schraube	Pul Stamp Ring	Anahtar Allen Key Innerschlüsselschlüssel
ADKT-CD-R/L-2020-3-R20	●	○	20	20	125	20.3	20				
ADKT-CD-R/L-2525-3-R23	●	○	25	25	150	25.3	23	<b>GX24 0300</b>	2004-M8x1x20	-	AAL-05-4

CRTZT Ucuna Uygun. / Compatible with CRTZT Insert. / Kompatibel mit CRTZT Wendeplatten.



Takım Kodu Ordering Code Bestell-Bezeichnung	Stok Stock Lager		Takım Ölçüleri (mm) Dimension (mm) Abmessung (mm)				Kesici Uç Insert Wendeschneidplatte	Yedek Parçaları / Spare Parts / Ersatzteile			
	R	L	HF=H	B	LF	WF		CDX	Sıkma Vidası Screw Schraube	Pul Stamp Ring	Anahtar Allen Key Innerschlüsselschlüssel
ADKT-SWC-R/L-2020-2-T25	●	○	20	20	125	20.3	25				
ADKT-SWC-R/L-2020-3-T25	●	○	20	20	125	20.4	25	<b>WCF-3</b>	2004-M8x1x20	-	AAL-05-4

R: Sağ / Right / Rechts L: Sol/Left/Links

● Stokta / In Stock / Auf Lager ○ Stokta Yok / Non Stock Item / Kein Lagerartikel, Lieferzeit auf Anfrage  
SMTM Ucuna Uygun. / Compatible with SMTM Insert. / Kompatibel mit SMTM Wendeplatten.

Sipariş Örneği/Ordering Example/Bestellbeispiel  
1 ad./pcs./stück ADKT-CD-R-2020-3-R20



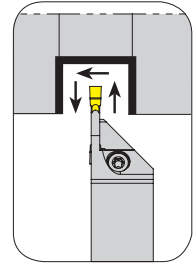
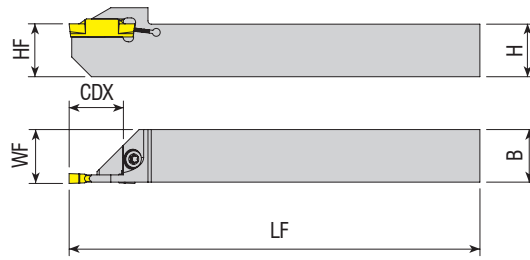

Takım Kodu Ordering Code Bestell-Bezeichnung	Stok Stock Lager		Takım Ölçüleri (mm) Dimension (mm) Abmessung (mm)					Kesici Uç Insert Wendeschneidplatte	Yedek Parçaları / Spare Parts / Ersatzteile		
	R	L	HF=H	B	LF	WF	CDX		Sıkma Vidası Screw Schraube	Pul Stamp Ring	Anahtar Allen Key Innerschlüssel
ADKT-TD-R/L-1212-2-T12-K-S	●	●	12	12	125	12.2	12	TD - 2	4015-M4x11	-	80-T15
ADKT-TD-R/L-1616-2-T16-K-S	●	●	16	16	125	16.2	16				
ADKT-TD-R/L-1212-3-T12-K-S	●	●	12	12	125	12.3	12	TD - 3	4015-M4x11	-	80-T15
ADKT-TD-R/L-1616-3-T16-K-S	●	●	16	16	125	16.3	16				

TGTC Ucuna Uygun. / Compatible with TGTC Insert. / Kompatibel mit TGTC Wendepatten.

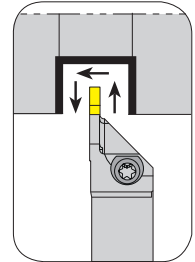
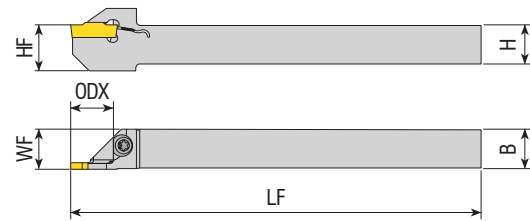

Takım Kodu Ordering Code Bestell-Bezeichnung	Stok Stock Lager		Takım Ölçüleri (mm) Dimension (mm) Abmessung (mm)					Kesici Uç Insert Wendeschneidplatte	Yedek Parçaları / Spare Parts / Ersatzteile		
	R	L	HF=H	B	LF	WF	CDX		Sıkma Vidası Screw Schraube	Pul Stamp Ring	Tork Anahtar Torx Key Torx-Schlüssel
ADKT-RD-R/L-1212-2-T12-K-S	●	●	12	12	125	12.2	12	RD - 2	4015-M4x11	-	80-T15
ADKT-RD-R/L-1616-2-T17-K-S	○	●	16	16	125	16.2	17				
ADKT-RD-R/L-1212-3-T12-K-S	●	●	12	12	125	12.2	12	RD - 3	4015-M4x11	-	80-T15

R: Sağ / Right / Rechts L: Sol/Left/Links  
● Stokta / In Stock / Auf Lager ○ Stokta Yok / Non Stock Item / Kein Lagerartikel, Lieferzeit auf Anfrage  
TGTC Ucuna Uygun. / Compatible with TGTC Insert. / Kompatibel mit TGTC Wendepatten.

Sipariş Örneği/Ordering Example/Bestellbeispiel  
1 ad./pcs./stück ADKT-TD-R-1212-2-T12-K-S

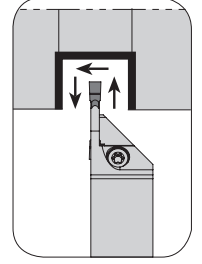
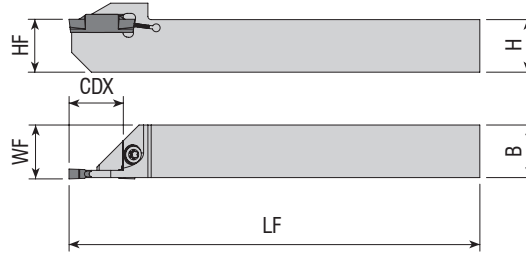

Takım Kodu Ordering Code Bestell-Bezeichnung	Stok Stock Lager		Takım Ölçüleri (mm) Dimension (mm) Abmessung (mm)					Kesici Uç Insert Wendeschneidplatte	Yedek Parçaları / Spare Parts / Ersatzteile		
	R	L	HF=H	B	LF	WF	CDX		Sıkma Vidası Screw Schraube	Pul Stamp Ring	Anahtar Allen Key Innensechskantschlüssel
ADKT-ZCC2-R/L-1010-2-T12-K-S	●	●	10	10	125	10.2	12	Z.BD - 2	4015-M4x11	-	80-T15
ADKT-ZCC2-R/L-1212-2-T12-K-S	●	●	12	12	125	12.2	12				
ADKT-ZCC2-R/L-1616-2-R16-K-S	●	●	16	16	125	16.2	16	Z.FD - 3			
ADKT-ZCC2-R/L-1212-3-T12-K-S	●	●	12	12	125	12.3	12				

ZCC Ucuna Uygundur. / Compatible with ZCC Insert. / Kompatibel mit ZCC Wendeplatten.

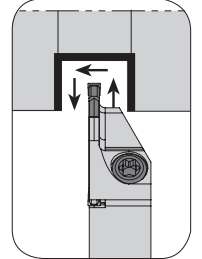
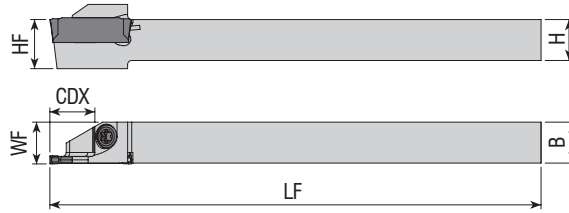

Takım Kodu Ordering Code Bestell-Bezeichnung	Stok Stock Lager		Takım Ölçüleri (mm) Dimension (mm) Abmessung (mm)					Kesici Uç Insert Wendeschneidplatte	Yedek Parçaları / Spare Parts / Ersatzteile		
	R	L	HF=H	B	LF	WF	CDX		Sıkma Vidası Screw Schraube	Pul Stamp Ring	Anahtar Allen Key Innensechskantschlüssel
ADKT-I-R/L-0808-2-R10-S	●	●	08	08	100	8.2	10	DGN - 2	4015-M4x11	-	80-T15
ADKT-I-R/L-1010-2-R10-K-S	●	●	10	10	125	10.2	10				
ADKT-I-R/L-1212-2-R12-K-S	●	●	12	12	125	12.2	12	DGN - 3			
ADKT-I-R/L-1616-3-R16-K-S	●	●	16	16	125	16.3	16				

R: Sağ / Right / Rechts L: Sol/Left/Links  
● Stokta / In Stock / Auf Lager ○ Stokta Yok / Non Stock Item / Kein Lagerartikel, Lieferzeit auf Anfrage  
ISCR Ucuna Uygundur. / Compatible with ISCR Insert. / Kompatibel mit ISCR Wendeplatten.

Sipariş Örneği/Ordering Example/Bestellbeispiel  
1 ad./pcs./stück ADKT-ZCC2-R-1010-2-T12-K-S

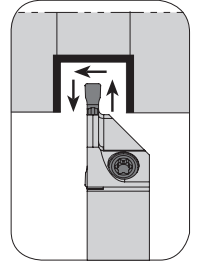
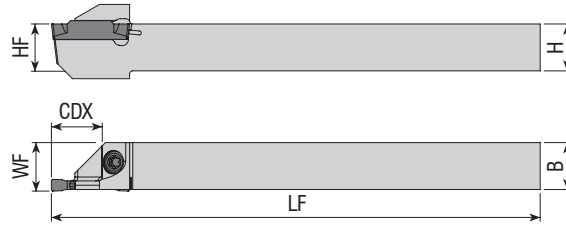

Takım Kodu Ordering Code Bestell-Bezeichnung	Stok Stock Lager		Takım Ölçüleri (mm) Dimension (mm) Abmessung (mm)				Kesici Uç Insert Wendeschneidplatte	Yedek Parçaları / Spare Parts / Ersatzteile			
	R	L	HF=H	B	LF	WF		CDX	Sıkma Vidası Screw Schraube	Pul Stamp Ring	Anahtar Allen Key Innensechskantschlüssel
ADKT-KG-R/L-1212-2-R12-K-S	●	●	12	12	125	12.2	12	KG. - 2	4015-M4x11	-	80-T15
ADKT-KG-R/L-1616-2-R16-K-S	●	●	16	16	125	16.2	16				
ADKT-KG-R/L-1212-3-R12-K-S	●	●	12	12	125	12.3	12	KG. - 3	4015-M4x11	-	80-T15
ADKT-KG-R/L-1616-3-R16-K-S	●	●	16	16	125	16.3	16				

KRLY Ucuna Uygun. / Compatiple with KRLY Insert. / Kompatibel mit KRLY Wendeplatten.

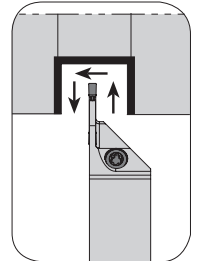
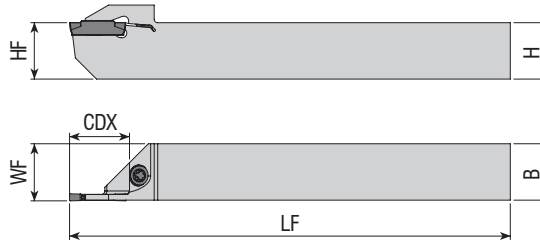

Takım Kodu Ordering Code Bestell-Bezeichnung	Stok Stock Lager		Takım Ölçüleri (mm) Dimension (mm) Abmessung (mm)				Kesici Uç Insert Wendeschneidplatte	Yedek Parçaları / Spare Parts / Ersatzteile			
	R	L	HF=H	B	LF	WF		CDX	Sıkma Vidası Screw Schraube	Pul Stamp Ring	Anahtar Allen Key Innensechskantschlüssel
ADKT-K-R/L-1212-2-R12-K-S	●	●	12	12	125	12.20	12	MGM. - 2	4015-M4x11	-	80-T15
ADKT-K-R/L-1616-2-R16-K-S	●	●	16	16	125	16.20	16				
ADKT-K-R/L-1212-3-R12-K-S	●	●	12	12	125	12.30	12	MGM. - 3	4015-M4x11	-	80-T15
ADKT-K-R/L-1616-3-R16-K-S	●	●	16	16	125	16.30	16				

R: Sağ / Right / Rechts L: Sol/Left/Links

● Stokta / In Stock / Auf Lager ○ Stokta Yok / Non Stock Item / Kein Lagerartikel, Lieferzeit auf Anfrage  
KRLY Ucuna Uygun. / Compatiple with KRLY Insert. / Kompatibel mit KRLY Wendeplatten.

Sipariş Örneği/Ordering Example/Bestellbeispiel  
1 ad./pcs./stück ADKT-KG-R-1212-2-R12-K-S

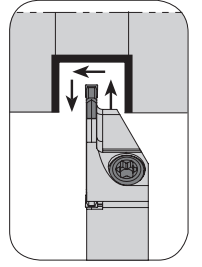
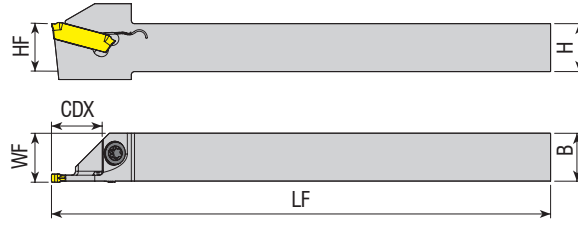

Takım Kodu Ordering Code Bestell-Bezeichnung	Stok Stock Lager		Takım Ölçüleri (mm) Dimension (mm) Abmessung (mm)				Kesici Uç Insert Wendeschneidplatte	Yedek Parçaları / Spare Parts / Ersatzteile			
	R	L	HF=H	B	LF	WF		CDX	Sıkma Vidası Screw Schraube	Pul Stamp Ring	Anahtar Allen Key Innensechskantschlüssel
ADKT-WGX16-R/L-1212-2-R12-K-S	●	●	12	12	125	12.2	12	GX16 - 2	4015-M4x11	-	80-T15
ADKT-WGX16-R/L-1616-2-R16-K-S	●	○	16	16	125	16.2	16				
ADKT-WGX24-R/L-1616-3-R16-K-S	●	○	16	16	125	16.3	16	GX24 - 3			

WLTR Ucuna Uygundur. / Compatible with WLTR Insert. / Kompatibel mit WLTR Wendeplatten.

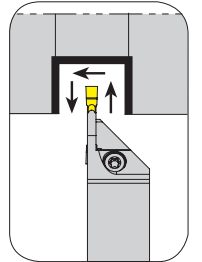
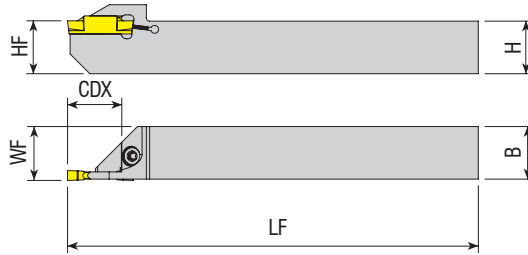

Takım Kodu Ordering Code Bestell-Bezeichnung	Stok Stock Lager		Takım Ölçüleri (mm) Dimension (mm) Abmessung (mm)				Kesici Uç Insert Wendeschneidplatte	Yedek Parçaları / Spare Parts / Ersatzteile			
	R	L	HF=H	B	LF	WF		CDX	Sıkma Vidası Screw Schraube	Pul Stamp Ring	Tork Anahtar Torx Key Torx-Schlüssel
ADKT-TG-R/L-1212-2-R12-K-S	●	○	12	12	125	12.2	12	DGM2-020 DGM3-020	4015-M4x11	-	80-T15
ADKT-TG-R/L-1212-3-R12-K-S	●	○	12	12	125	12.3	12				

R: Sağ / Right / Rechts L: Sol/Left/Links  
● Stokta / In Stock / Auf Lager ○ Stokta Yok / Non Stock Item / Kein Lagerartikel, Lieferzeit auf Anfrage  
TNGLY Ucuna Uygundur. / Compatible with TNGLY Insert. / Kompatibel mit TNGLY Wendeplatten.

Sipariş Örneği/Ordering Example/Bestellbeispiel  
1 ad./pcs./stück ADKT-WGX16-R-1212-2-R12-K-S



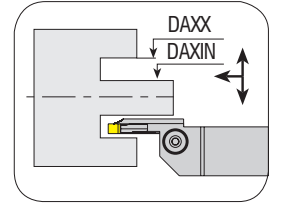
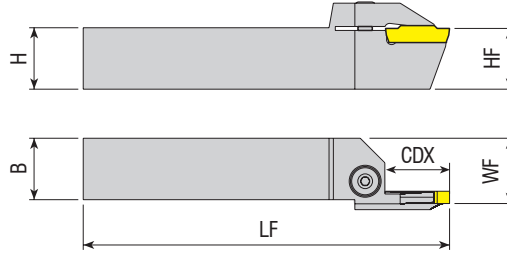

**Takım Kodu**  
**Ordering Code**  
*Bestell-Bezeichnung*

Stok Stock Lager	Takım Ölçüleri (mm) Dimension (mm) Abmessung (mm)									Kesici Uç Insert Wendeschneidplatte	Yedek Parçaları / Spare Parts / Ersatzteile		
	R	L	HF=H	B	LF	WF	CDX	DAXIN	DAXX		Sıkma Vidası Screw Schraube	Pul Stamp Ring	Anahtar Allen Key Inmenschlüssel
●	●	25	25	150	26.5	17	34	45	MGM. - 3				
●	●	25	25	150	26.5	17	39	55					
●	●	25	25	150	26.5	17	49	80					
●	●	25	25	150	26.5	17	70	110					
●	●	25	25	150	26.5	17	100	150					
●	●	25	25	150	26.5	32	80	180					
●	●	25	25	150	26.5	22	175	215					
●	●	25	25	150	26.5	17	700	800					
●	●	25	25	150	26.5	22	50	85	MGM. - 4	2004-M8x1x20	-	AAL-05-4	
●	●	25	25	150	26.5	22	70	110					
●	●	25	25	150	26.5	22	100	150					
●	●	25	25	150	26.5	32	80	180					
●	●	25	25	150	26.5	32	180	800					
●	●	25	25	150	26.5	25	70	110	MGM. - 5				
●	●	25	25	150	26.5	25	100	150					
●	●	25	25	150	26.5	32	80	180					
●	●	25	25	150	26.5	32	180	800					
●	●	25	25	150	26.5	25	60	100	MGM. - 6				
●	○	25	25	150	26.5	35	60	100					
●	○	25	25	150	26.5	25	100	200					
●	○	25	25	150	26.5	35	100	200					
●	○	25	25	150	26.5	45	100	200					
●	●	25	25	150	26.5	35	140	300	MGM. - 8				
●	○	25	25	150	26.5	35	140	300					
●	○	32	32	150	33.5	35	140	350					

R: Sağ / Right / Rechts L: Sol/Left/Links

● Stokta / In Stock / Auf Lager ○ Stokta Yok / Non Stock Item / Kein Lagerartikel, Lieferzeit auf Anfrage

KRLY Ucuna Uygundur. / Compatible with KRLY Insert. / Kompatibel mit KRLY Wendeplatten.

Sipariş Örneği/Ordering Example/Bestellbeispiel

1 ad./pcs./stück AAKT-K-R-2525-34-45-3-T17

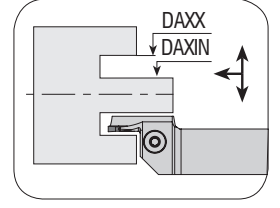
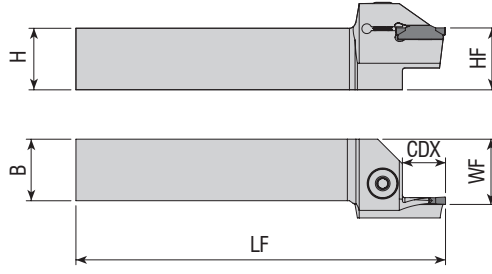

**Takım Kodu**  
**Ordering Code**  
**Bestell-Bezeichnung**

Takım Kodu Ordering Code Bestell-Bezeichnung	Takım Ölçüleri (mm) Dimension (mm) Abmessung (mm)									Kesici Uç Insert Wendeschneidplatte	Yedek Parçaları / Spare Parts / Ersatzteile			
	R	L	HF=H	B	LF	WF	CDX	DAXIN	DAXX		Sıkma Vidası Screw Schraube	Pul Stamp Ring	Anahtar Allen Key Innerschraubenschlüssel	
AAKT-ZCC2-R/L-2525-140-180-2-T4	●	○	25	25	150	26.5	4	140	180	Z.BD - 2	2004-M8x1x20	-	AAL-05-4	
AAKT-ZCC2-R/L-2525-35-45-3-T17	●	●	25	25	150	26.5	17	35	45	Z.FD - 3				
AAKT-ZCC2-R/L-2525-39-55-3-T17	●	○	25	25	150	26.5	17	39	55					
AAKT-ZCC2-R/L-2525-49-80-3-T17	●	●	25	25	150	26.5	17	49	80					
AAKT-ZCC2-R/L-2525-70-110-3-T15	●	○	25	25	150	26.5	15	70	110					
AAKT-ZCC2-R/L-2525-70-110-3-T17	●	●	25	25	150	26.5	17	70	110					
AAKT-ZCC2-R/L-2525-100-150-3-T17	●	●	25	25	150	26.5	17	100	150					
AAKT-ZCC2-R/L-2525-40-60-4-T22	●	○	25	25	150	26.5	22	40	60	Z.GD - 4				
AAKT-ZCC2-R/L-2525-52-80-4-T22	●	●	25	25	150	26.5	22	52	80					
AAKT-ZCC2-R/L-2525-72-110-4-T22	●	●	25	25	150	26.5	22	72	110					
AAKT-ZCC2-R/L-2525-100-150-4-T22	●	●	25	25	150	26.5	22	100	150					
AAKT-ZCC2-R/L-2525-140-200-4-T22	●	●	25	25	150	26.5	22	140	200	Z.HD - 5				
AAKT-ZCC2-R/L-2525-55-95-5-T25	●	○	25	25	150	26.5	25	55	95					
AAKT-ZCC2-R/L-2525-85-140-5-T25	●	●	25	25	150	26.5	25	85	140					
AAKT-ZCC2-R/L-2525-130-200-5-T25	●	○	25	25	150	26.5	25	130	200					
AAKT-ZCC2-R/L-2525-190-400-5-T25	●	●	25	25	150	26.5	25	190	400					
AAKT-ZCC2-R/L-2525-190-400-5-T35	●	○	25	25	150	26.5	35	190	400					
AAKT-ZCC2-R/L-2525-200-500-5-T17	●	●	25	25	150	26.5	17	200	500	Z.KD - 6				
AAKT-ZCC2-R/L-2525-60-110-6-T15	●	○	25	25	150	26.5	15	60	110					

ZCC Ucuna Uygundur. / Compatible with ZCC Insert. / Kompatibel mit ZCC Wendeplatten.

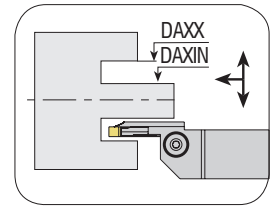
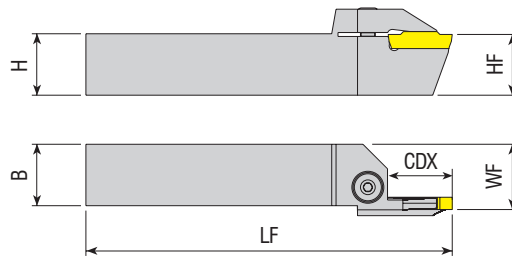

Takım Kodu Ordering Code Bestell-Bezeichnung	Stok Stock Lager	Takım Ölçüleri (mm) Dimension (mm) Abmessung (mm)									Kesici Uç Insert Wendeschneidplatte	Yedek Parçaları / Spare Parts / Ersatzteile			
		R	L	HF=H	B	LF	WF	CDX	DAXIN	DAXX		Sıkma Vidası Screw Schraube	Pul Stamp Ring	Anahtar Allen Key Innerschraubenschlüssel	
AAKT-KG-R/L-2525-44-70-4-T22	○	○	25	25	150	26.5	22	44	70	KG.. - 4	2004-M8x1x20	-	AAL-05-4		
AAKT-KG-R/L-2525-60-120-4-T22	○	○	25	25	150	26.5	22	60	120						
AAKT-KG-R/L-2525-112-200-4-T22	○	○	25	25	150	26.5	22	112	200						

R: Sağ / Right / Rechts L: Sol/Left/Links  
● Stokta / In Stock / Auf Lager ○ Stokta Yok / Non Stock Item / Kein Lagerartikel, Lieferzeit auf Anfrage  
KRLY Ucuna Uygundur. / Compatible with KRLY Insert. / Kompatibel mit KRLY Wendeplatten.

Sipariş Örneği/Ordering Example/Bestellbeispiel  
1 ad./pcs./stück AAKT-ZCC2-R-2525-140-180-2-T4

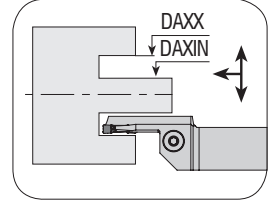
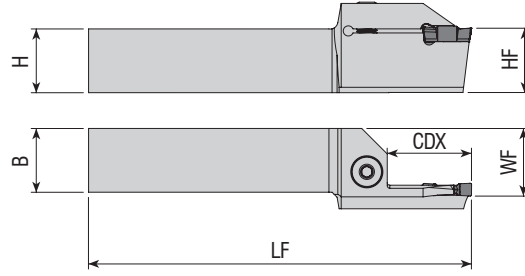

**Takım Kodu**  
**Ordering Code**  
*Bestell-Bezeichnung*

Stok Stock Lager	Takım Ölçüleri (mm) Dimension (mm) Abmessung (mm)									Kesici Uç Insert Wendeschneidplatte	Yedek Parçaları / Spare Parts / Ersatzteile		
	R	L	HF=H	B	LF	WF	CDX	DAXIN	DAXX		Sıkma Vidası Screw Schraube	Pul Stamp Ring	Anahtar Allen Key Innerschlüsselschlüssel
●	●	25	25	150	26.5	25	40	60	DGN / GRP - 4	2004-M8x1x20	-	AAL-05-4	
●	●	25	25	150	26.5	25	52	80					
●	●	25	25	150	26.5	28	70	110					
○	○	25	25	150	26.5	25	72	110					
●	○	25	25	150	26.5	25	100	150					
●	○	25	25	150	26.5	28	110	200					
●	●	25	25	150	26.5	32	110	200					
○	○	25	25	150	26.5	25	140	200					
●	●	25	25	150	26.5	28	180	800					
○	○	25	25	150	26.5	25	200	800					
●	●	25	25	150	26.5	32	70	110	DGN / GRP - 5				
●	○	25	25	150	26.5	9	110	200					
●	●	25	25	150	26.5	32	110	200					
●	●	25	25	150	26.5	32	180	800	DGN / GRP - 6				
●	○	25	25	150	26.5	32	58	100					
●	○	25	25	150	26.5	32	88	180					

R: Sağ / Right / Rechts L: Sol/Left/Links

● Stokta / In Stock / Auf Lager ○ Stokta Yok / Non Stock Item / Kein Lagerartikel, Lieferzeit auf Anfrage  
ISCR Uçuna Uygun. / Compatible with ISCR Insert. / Kompatibel mit ISCR Wendeplatten.

Sipariş Örneği/Ordering Example/Bestellbeispiel  
1 ad./pcs./stück AAKT-IG-R-2525-40-60-4-T25



**L TİP ALIN KANAL AÇMA TAKIMLARI**  
**L TYPE FACE EXTERNAL GROOVING TOOLHOLDERS**  
 AXIAL STECHHALTER L-TYPE

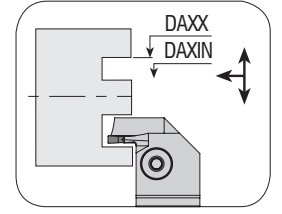
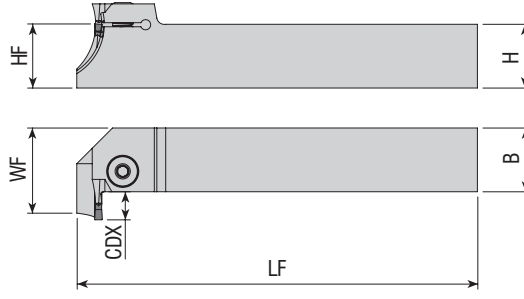

Takım Kodu Ordering Code Bestell-Bezeichnung	Stok Stock Lager		Takım Ölçüleri (mm) Dimension (mm) Abmessung (mm)							Kesici Uç Insert Wendeschneidplatte	Yedek Parçaları / Spare Parts / Ersatzteile		
	R	L	HF=H	B	LF	WF	CDX	DAXIN	DAXX		Sıkma Vidası Screw Schraube	Pul Stamp Ring	Anahtar Allen Key Innerschraubschlüssel
ALKT-ZCC2-R/L-2525-35-45-3-T10	●	●	25	25	150	36	10	35	45	Z.FD - 3	2004-M8x1x20	-	AAL-05-4
ALKT-ZCC2-R/L-2525-39-55-3-T10	●	●	25	25	150	36	10	39	55				
ALKT-ZCC2-R/L-2525-35-∞-3-T4	●	●	25	25	150	30	4	35	∞				
ALKT-ZCC2-R/L-2525-40-60-4-T14	●	●	25	25	150	40	14	40	60	Z.GD - 4	-	AAL-05-4	
ALKT-ZCC2-R/L-2525-52-80-4-T14	●	○	25	25	150	40	14	52	80				
ALKT-ZCC2-R/L-2525-72-110-4-T14	●	○	25	25	150	40	14	72	110				
ALKT-ZCC2-R/L-2525-100-230-4-T14	●	○	25	25	150	40	14	100	230				
ALKT-ZCC2-R/L-2525-40-∞-4-T4	●	●	25	25	150	30	4	40	∞				

ZCC Ucuna Uygundur. / Compatible with ZCC Insert. / Kompatibel mit ZCC Wendeleplatten.

**KESME VE DERİN KANAL AÇMA LAMALARI**  
**BLADES FOR PARTING AND DEEP GROOVING**  
 STECHSCHWERT FÜR ABSTECHEN UND TIEFE EINSTICHE

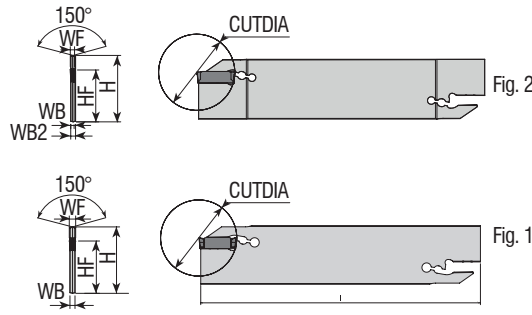
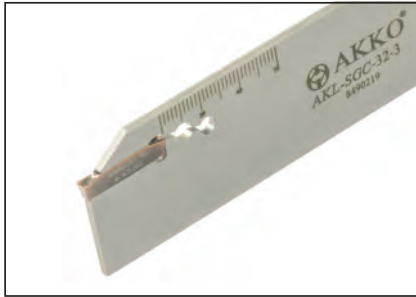

Takım Kodu Ordering Code Bestell-Bezeichnung	Stok Stock Lager	Takım Ölçüleri (mm) Dimension (mm) Abmessung (mm)								Kesici Uç Insert Wendeschneidplatte	Yedek Parçaları / Spare Parts Ersatzteile
		H	WF	WB2	WB	I	HF	CUTDIA	Fig.		Anahtar Allen Key Innerschraubschlüssel
AKL-SGC-26-3	●	26	3	2.40	-	110	21.4	39	2	GCM N30	ALA-02
AKL-SGC-32-3	●	32	3	2.40	-	150	25	39	1		

R: Sağ / Right / Rechts L: Sol/Left/Links

● Stokta / In Stock / Auf Lager ○ Stokta Yok / Non Stock Item / Kein Lagerartikel, Lieferzeit auf Anfrage  
 SMTM Ucuna Uygundur. / Compatible with SMTM Insert. / Kompatibel mit SMTM Wendeleplatten.



Sipariş Örneği/Ordering Example/Bestellbeispiel  
 1 ad./pcs./stück ALKT-ZCC2-R-2525-35-45-3-T10



www.akko.com.tr

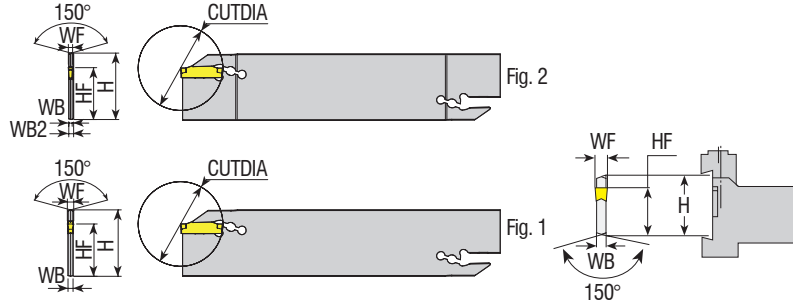

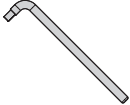

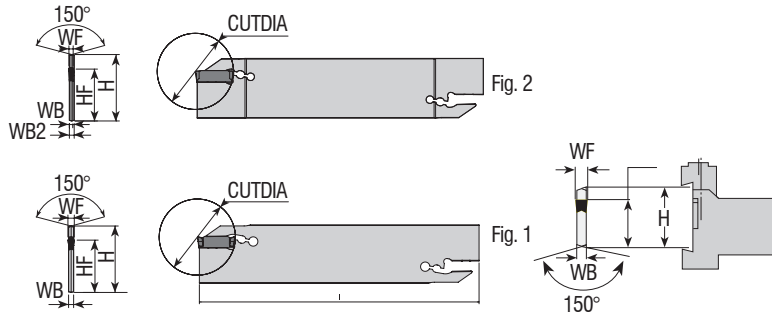

Takım Kodu Ordering Code Bestell-Bezeichnung	Stok Stock Lager	Takım Ölçüleri (mm) Dimension (mm) Abmessung (mm)								Kesici Uç Insert Wendeschneidplatte	Yedek Parçaları / Spare Parts Ersatzteile
		H	WF	WB2	WB	I	HF	CUTDIA	Fig.		
AKL-TD-32-2	●	32	2	2.4	1.6	150	25	39	2		
AKL-TD-32-3	●	32	3	2.4	-	150	25	39	1		

TGTC Ucuna Uygun. / Compatible with TGTC Insert. / Kompatibel mit TGTC Wendeplatten.

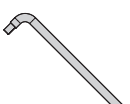

Takım Kodu Ordering Code Bestell-Bezeichnung	Stok Stock Lager	Takım Ölçüleri (mm) Dimension (mm) Abmessung (mm)								Kesici Uç Insert Wendeschneidplatte	Yedek Parçaları / Spare Parts Ersatzteile
		H	WF	WB2	WB	I	HF	CUTDIA	Fig.		
AKL-I-26-2	●	26	1.9-2.5	1.6	-	110	21.4	39	1		
AKL-I-32-2	●	32	1.9-2.5	1.8	2.4	150	25	39	2		
AKL-I-26-3	●	26	3-3.18	2.4	-	110	21.4	39	1		ALA-02
AKL-I-32-3	●	32	3-3.18	2.4	-	150	25	39	1		
AKL-I-26-4	●	26	4	3.2	-	110	21.4	80	1		ALA-02
AKL-I-32-4	●	32	4	3.2	-	150	25	100	1		

R: Sağ / Right / Rechts L: Sol/Left/Links  
● Stokta / In Stock / Auf Lager ○ Stokta Yok / Non Stock Item / Kein Lagerartikel, Lieferzeit auf Anfrage  
ISCR Ucuna Uygun. / Compatible with ISCR Insert. / Kompatibel mit ISCR Wendeplatten.

Sipariş Örneği/Ordering Example/Bestellbeispiel  
1 ad./pcs./stück AKL-TD-32-2

**KESME VE DERİN KANAL AÇMA LAMALARI**  
**BLADES FOR PARTING AND DEEP GROOVING**  
**STECHSCHWERT FÜR ABSTECHEN UND TIEFE EINSTICHE**

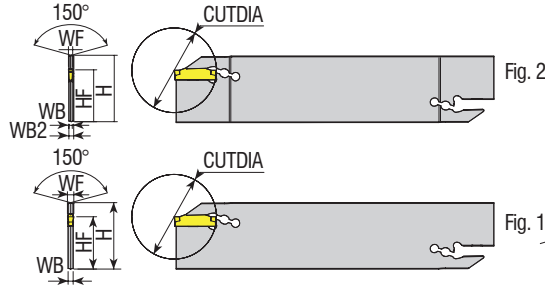

Takım Kodu Ordering Code Bestell-Bezeichnung	Stok Stock Lager	Takım Ölçüleri (mm) Dimension (mm) Abmessung (mm)								Kesici Uç Insert Wendeschneidplatte	Yedek Parçaları / Spare Parts Ersatzteile	
		H	WF	WB2	WB	I	HF	CUTDIA	Fig.		Anahtar Allen Key Innerschlüssel	
AKL-123-32-2	●	32	2	2.4	1.6	150	25	39	2		ALA-02	
AKL-123-32-3	●	32	3	2.4	-	150	25	39	1			
AKL-123-32-4	●	32	4	3.2	-	150	25	39	1			

SNDVK Ucuna Uygundur. / Compatible with SNDVK Insert. / Kompatibel mit SNDVK Wendepplatten.

**KESME VE DERİN KANAL AÇMA LAMA BLOĞU**  
**BLOCKS FOR PARTING AND DEEP GROOVING BLADES**  
**SPANNBLOCK FÜR STECHSCHWERT**

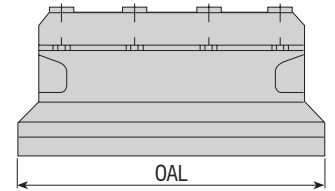
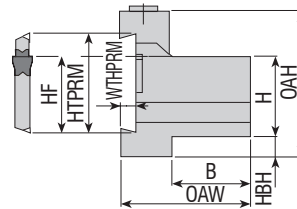

Takım Kodu Ordering Code Bestell-Bezeichnung	Stok Stock Lager	Takım Ölçüleri (mm) Dimension (mm) Abmessung (mm)									Yedek Parçaları / Spare Parts / Ersatzteile		
		HTPRM	HF	H	HBH	OAH	WTHPRM	OAL	B	OAW	Pabuç Clamp Spannspratze	Pabuç Vidası Clamp Screw Klemmschraube	Anahtar Allen Key Innerschlüssel
ALBU-20-26	●	26	21.4	20	9	43	4	86	19	38		2505-M6x25	AAL-07-5
ALBU-25-26	●	26	21.4	25	5	45	4	110	23	42			
ALBU-20-32	●	32	25	20	13	50	5.3	100	19	38		2505-M6x30	
ALBU-25-32	●	32	25	25	8	50	5.3	110	23	42			
ALBU-32-32	●	32	25	32	5	54	5.3	110	29	48			

R: Sağ / Right / Rechts L: Sol/Left/Links

● Stokta / In Stock / Auf Lager ○ Stokta Yok / Non Stock Item / Kein Lagerartikel, Lieferzeit auf Anfrage

Sipariş Örneği/Ordering Example/Bestellbeispiel

1 ad./pcs./stück AKL-123-32-2

*konusulan  
the spoken kalite...  
quality...*



*konusulan  
the spoken kalite...  
quality...*

# KANAL AÇMA

İÇTEN SOĞUTMA KANALLI KANAL AÇMA TAKIMLARI  
GROOVING TOOLHOLDERS WITH COOLANT TOOLS  
STECHHALTER MIT KÜHLWERKZEUG





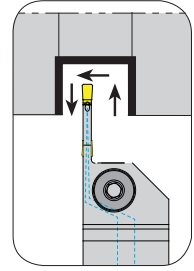
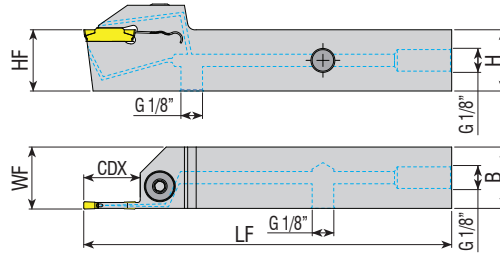

**Takım Kodu**  
**Ordering Code**  
**Bestell-Bezeichnung**

Stok Stock Lager		Takım Ölçüleri (mm) Dimension (mm) Abmessung (mm)					Kesici Uç Insert Wendeschneidplatte	Yedek Parçaları / Spare Parts / Ersatzteile		
R	L	HF=H	B	LF	WF	CDX	Sıkma Vidası Screw Schraube	Pul Stamp Ring	Anahtar Allen Key Inmenschlüsselschlüssel	
●	●	20	20	125	20.4	20	MGM. - 3	2004-M8x1x20	-	AAL-05-4
●	●	25	25	150	25.4	22	MGM. - 4			
●	●	20	20	125	20.4	20	MGM. - 5			
●	●	25	25	150	25.5	25				

KRLY Ucuna Uygun. / Compatible with KRLY Insert. / Kompatibel mit KRLY Wendeschneidplatten.

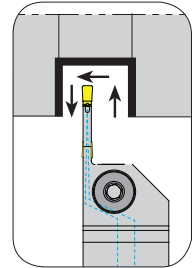
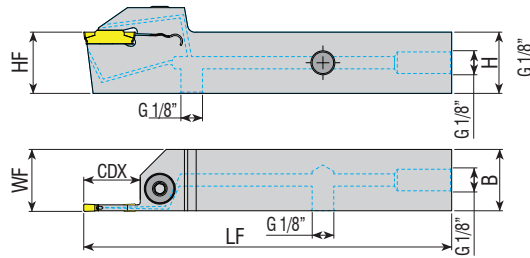

**Takım Kodu**  
**Ordering Code**  
**Bestell-Bezeichnung**

Stok Stock Lager		Takım Ölçüleri (mm) Dimension (mm) Abmessung (mm)					Kesici Uç Insert Wendeschneidplatte	Yedek Parçaları / Spare Parts / Ersatzteile		
R	L	HF=H	B	LF	WF	CDX	Sıkma Vidası Screw Schraube	Pul Stamp Ring	Anahtar Allen Key Inmenschlüsselschlüssel	
●	●	20	20	125	20.5	30	TD. - 3	2004-M8x1x20	-	AAL-05-4

R: Sağ / Right / Rechts L: Sol/Left/Links  
● Stokta / In Stock / Auf Lager ○ Stokta Yok / Non Stock Item / Kein Lagerartikel, Lieferzeit auf Anfrage  
TGTC Ucuna Uygun. / Compatible with TGTC Insert. / Kompatibel mit TGTC Wendeschneidplatten.

Sipariş Örneği/Ordering Example/Bestellbeispiel  
1 ad./pcs./stück ADKT-K-R-2020-3-T20-H

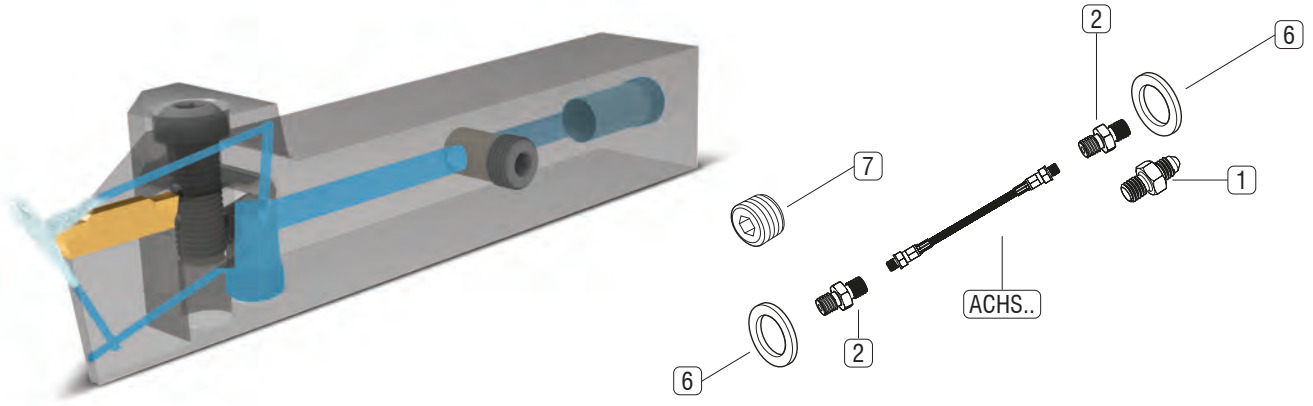

Not: İçten soğutmalı tüm torna katerlerinde kullanılabilecek 3 tip soğutma hortum setleri tasarlanmıştır. Takımların kullanılmasından önce, kullanılmayan bağlantıların set içindeki vida ile kapatılarak sızdırmazlığın sağlanmasına dikkat edilmelidir. Torna katerlerine yönelik soğutma hortum setleri, ACHS... 10 bar ile maksimum 275 bar basınç aralığında kullanılabilir.

Note: 3 types of cooling hose sets are designed that can be used in all internally cooled lathes. Before using the tools, care should be taken to ensure that the unused connections are closed with the screw in the set and that sealing is ensured. Cooling hose sets for lathe tools can be used in the pressure range of ACHS ... 10 bar to max 275 bar.

Note: Es wurden 3 Arten von Kühlschlauch-Sets entwickelt, die in allen intern gekühlten Drehmaschinen verwendet werden können. Vor der Verwendung der Werkzeuge sollte darauf geachtet werden, dass die nicht verwendeten Verbindungen mit der Schraube im Satz geschlossen werden und die Abdichtung gewährleistet ist. Kühlschlauchsätze für Drehmaschinen können im Druckbereich von ACHS ... 10 bar bis max. 275 bar eingesetzt werden.

Set İçindeki Parçalar Parts In The Set Telle im Set				Uzunluk / Length Code / Länge Einstellen: 250		
				Set Kodu: Set Code: Code Einstellen: ACHS-1-250	Set Kodu: Set Code: Code Einstellen: ACHS-2-250	Set Kodu: Set Code: Code Einstellen: ACHS-3-250
1		AMP-01	M10 Bağlantı Elemanı M10 Fastener M10 Verschluss	1x	-	-
2		AMP-02	G 1/8" Çift Bağlantı Elemanı G 1/8" Double Fastener G 1/8" Dopperverschluss	2x	1x	-
3		AMP-03	G 1/8" Açılı Bağlantısı G 1/8" Angle Connection G 1/8" Winkelverbindung	-	1x	2x
4		AMP-04	M10" Açılı Bağlantısı M10" Angle Connection M10" Winkelverbindung	-	1x	1x
5		AMP-05	G1/4"-G1/8" Kılcalma Parçası G1 / 4"-G1/8" Capillary Piece G1 / 4"-G1/8" Kapillarstück	-	1x	1x
6		AG-01	Bakır Conta Copper Gasket Kupferdichtung	2x	3x	4x
7		2705-G1/8-5.5	G1/8" Sızdırmaz Civata G1/8" Sealing Bolt G1/8" Dichtungsschraube	1x	1x	1x
8		AH-1-250	Hortum Hose Schlauch	1x	-	-
9		AH-2-250	Hortum Hose Schlauch	-	1x	-
10		AH-3-250	Hortum Hose Schlauch	-	-	1x

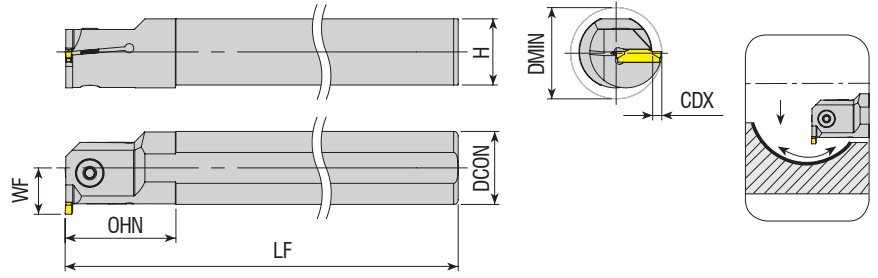

**Takım Kodu**  
**Ordering Code**  
**Bestell-Bezeichnung**

Stok  
Stock  
Lager

Takım Ölçüleri (mm)  
Dimension (mm)  
Abmessung (mm)

Kesici Uç  
Insert  
Wendeschneidplatte

Yedek Parçaları / Spare Parts / Ersatzteile

Sıkma Vidası  
Screw  
Schraube

Anahtar  
Allen Key  
Innensechskantschlüssel

Takım Kodu Ordering Code Bestell-Bezeichnung	Stok Stock Lager		Takım Ölçüleri (mm) Dimension (mm) Abmessung (mm)							Kesici Uç Insert Wendeschneidplatte	Sıkma Vidası Screw Schraube	Anahtar Allen Key Innensechskantschlüssel
	R	L	DCON	DMIN	LF	OHN	CDX	H	WF			
AIKT-K-R/L-16-2-T4	●	●	16	21	150	28	4	14.8	12	MGM. - 2	2503-M4x10	AAL-03-3
AIKT-K-R/L-20-2-T4	●	●	20	25	170	30	4	18.3	14		2503-M4x12	
AIKT-K-R/L-25-2-T6	●	●	25	32	200	40	6	23	18.5		2504-M5x12	
AIKT-K-R/L-20-3-T6	●	●	20	27	170	30	6	18.3	16	MGM. - 3	2504-M5x12	AAL-05-4
AIKT-K-R/L-20-3-T7	●	●	20	25	170	38	7	18.3	13		2504-M5x16	
AIKT-K-R/L-25-3-T6	●	●	25	32	200	40	6	23	18.5		2504-M5x16	
AIKT-K-R/L-25-3-T10	●	●	25	32	200	48	10	23	17		2004-M8x1x20	
AIKT-K-R/L-32-3-T6	●	●	32	39	250	50	6	30	22		2504-M5x12	
AIKT-K-R/L-32-3-T12	●	●	32	39	250	53	12	30	22		2504-M5x16	
AIKT-K-R/L-40-3-T6	●	●	40	47	300	55	6	37.5	26	MGM. - 4	2004-M8x1x20	AAL-05-4
AIKT-K-R/L-40-3-T12	●	○	40	48	300	63	12	37.5	27		2504-M5x12	
AIKT-K-R/L-20-4-T6	●	●	20	27	170	30	6	18.3	16		2504-M5x16	
AIKT-K-R/L-20-4-T7	●	○	20	25	170	38	7	18.3	13		2504-M5x16	
AIKT-K-R/L-25-4-T6	●	●	25	32	200	40	6	23	18.5		2004-M8x1x20	
AIKT-K-R/L-25-4-T10	●	●	25	32	200	49	10	23	17		2504-M5x12	
AIKT-K-R/L-32-4-T6	●	●	32	39	250	50	6	30	22	MGM. - 5	2504-M5x16	AAL-05-4
AIKT-K-R/L-32-4-T12	●	●	32	39	250	53	12	30	22		2004-M8x1x20	
AIKT-K-R/L-40-4-T6	●	●	40	47	300	55	6	37.5	26		2504-M5x16	
AIKT-K-R/L-40-4-T12	●	●	40	48	300	63	12	37.5	27	2004-M8x1x20		
AIKT-K-R/L-25-5-T7	●	●	25	33	200	40	7	23	19.5	MGM. - 5	2504-M5x16	AAL-05-4
AIKT-K-R/L-32-5-T7	●	●	32	40	250	50	7	30	23		2004-M8x1x20	
AIKT-K-R/L-40-5-T7	●	●	40	48	300	55	7	37.5	27		2504-M5x16	
AIKT-K-R/L-40-5-T12	●	○	40	48	300	63	12	37.5	27		2004-M8x1x20	

R: Sağ / Right / Rechts L: Sol/Left/Links  
● Stokta / In Stock / Auf Lager ○ Stokta Yok / Non Stock Item / Kein Lagerartikel, Lieferzeit auf Anfrage  
KRLY Ucuna Uygundur. / Compatibel with KRLY Insert. / Kompatibel mit KRLY Wendepplatten.

Sipariş Örneği/Ordering Example/Bestellbeispiel  
1 ad./pcs./stück AIKT-K-R-16-2-T4

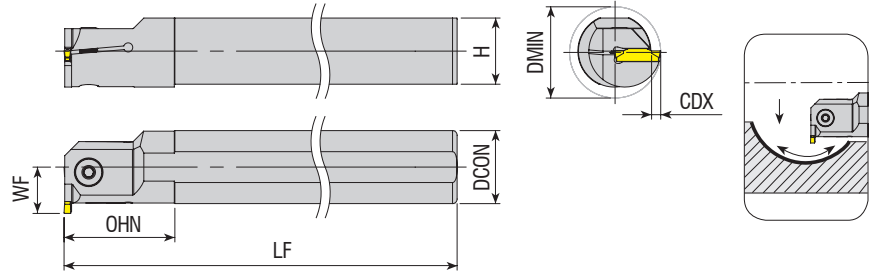

Takım Kodu Ordering Code Bestell-Bezeichnung	Stok Stock Lager		Takım Ölçüleri (mm) Dimension (mm) Abmessung (mm)							Kesici Uç Insert Wendeschneidplatte	Yedek Parçaları / Spare Parts / Ersatzteile	
	R	L	DCON	DMIN	LF	OHN	CDX	H	WF	Sıkma Vidası Screw Schraube	Anahtar Allen Key Innerschlüssel	
AIKT-KG-R/L-25-2-T7	●	●	25	33	200	40	7	23	19.5	KG.. - 2	2504-M5x12	AAL-05-4
AIKT-KG-R/L-20-3-T6.5-H	●	○	20	27.5	170	30	6.5	18.3	16.5	KG.. - 3	2504-M5x16	
AIKT-KG-R/L-25-3-T7	○	○	25	33	200	40	7	23	19.5		2004-M8x1x20	
AIKT-KG-R/L-40-3-T8	●	○	40	50	300	55	8	37.5	28	KG.. - 4	2504-M5x16	
AIKT-KG-R/L-25-4-T8	●	●	25	34	200	40	8	23	20.5			

KRLY Ucuna Uygun. / Compatible with KRLY Insert. / Kompatibel mit KRLY Wendeplatten.

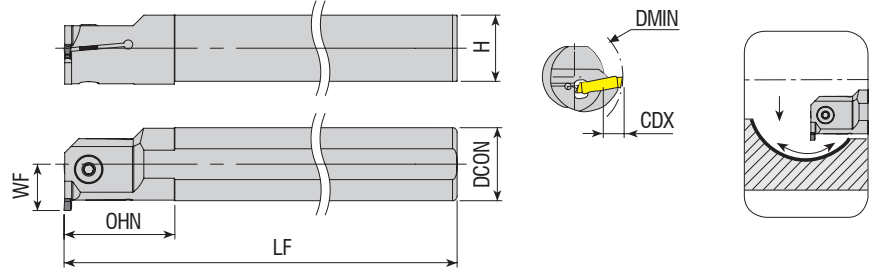

Takım Kodu Ordering Code Bestell-Bezeichnung	Stok Stock Lager		Takım Ölçüleri (mm) Dimension (mm) Abmessung (mm)							Kesici Uç Insert Wendeschneidplatte	Yedek Parçaları / Spare Parts / Ersatzteile	
	R	L	DCON	DMIN	LF	OHN	CDX	H	WF	Sıkma Vidası Screw Schraube	Anahtar Allen Key Innerschlüssel	
AIKT-H-R/L-25-3-T8	●	●	25	34	200	40	8	23	20.5	S229 - 3	2504-M5x16	AAL-05-4
AIKT-H-R/L-32-3-T7	●	●	32	40	250	50	7	30	23		2004-M8x1x20	
AIKT-H-R/L-40-3-T7	●	●	40	48	300	55	7	37.5	27			
AIKT-H-R/L-25-4-T8	●	●	25	34	200	40	8	23	20.5	S229 - 4	2504-M5x16	
AIKT-H-R/L-32-4-T7	●	●	32	40	250	50	7	30	23		2004-M8x1x20	
AIKT-H-R/L-40-4-T7	●	●	40	48	300	55	7	37.5	27	S229 - 5	2504-M5x16	
AIKT-H-R/L-25-5-T8	●	●	25	34	200	40	8	23	20.5		2004-M8x1x20	
AIKT-H-R/L-32-5-T7	●	○	32	40	250	50	7	30	23			
AIKT-H-R/L-40-5-T7	●	○	40	48	300	55	7	37.5	27			

R: Sağ / Right / Rechts L: Sol/Left/Links

● Stokta / In Stock / Auf Lager ○ Stokta Yok / Non Stock Item / Kein Lagerartikel, Lieferzeit auf Anfrage  
HRN Ucuna Uygun. / Compatible with HRN Insert. / Kompatibel mit HRN Wendeplatten.

Sipariş Örneği/Ordering Example/Bestellbeispiel  
1 ad./pcs./stück AIKT-KG-R-25-2-T7



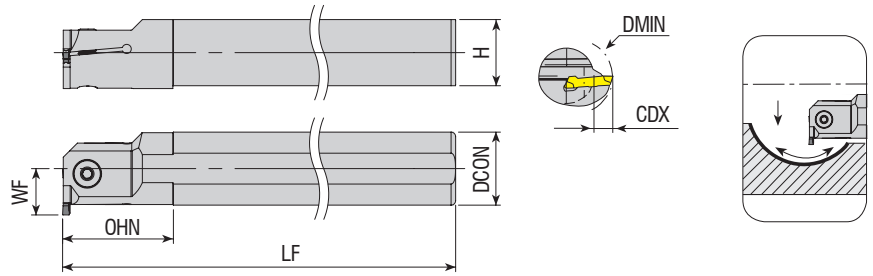

Takım Kodu Ordering Code Bestell-Bezeichnung	Stok Stock Lager		Takım Ölçüleri (mm) Dimension (mm) Abmessung (mm)							Kesici Uç Insert Wendeschneidplatte	Yedek Parçaları / Spare Parts / Ersatzteile	
	R	L	DCON	DMIN	LF	OHN	CDX	H	WF		Sıkma Vidası Screw Schraube	Anahtar Allen Key Innensechskantschlüssel
AIKT-HK-R/L-20-2-T6	●	●	20	26	170	30	6	18.3	16	S224 - 2	2503-M4x12	AAL-03-3
AIKT-HK-R/L-25-2-T6	●	○	25	32	200	40	6	23	18.5		2504-M5x16	AAL-05-4
AIKT-HK-R/L-20-3-T6	●	○	20	27	170	30	6	18.3	16	S224 - 3	2504-M5x12	
AIKT-HK-R/L-25-3-T6	●	●	25	32	200	40	6	23	18.5		2504-M5x16	
AIKT-HK-R/L-32-3-T6	●	●	32	39	250	50	6	30	22	S224 - 4	2004-M8x1x20	AAL-05-4
AIKT-HK-R/L-20-4-T6	●	○	20	27	170	30	6	18.3	16		2504-M5x12	
AIKT-HK-R/L-25-4-T6	●	○	25	32	200	40	6	23	18.5	2504-M5x16	AAL-05-4	
AIKT-HK-R/L-32-4-T6	●	○	32	39	250	50	6	30	22	2004-M8x1x20		
AIKT-HS223-R/L-20-2-T5	●	○	20	26	170	33	5	18.3	15	S223 - 2	2503-M4x12	AAL-03-3
AIKT-HS223-R/L-25-2-T5	●	○	25	31	200	40	5	23	17.5		2504-M5x16	AAL-05-4
AIKT-HS223-R/L-20-3-T6	●	○	20	27	170	33	6	18.3	16	S223 - 3	2504-M5x12	
AIKT-HS223-R/L-25-3-T6	●	○	25	32	200	40	6	23	18.5		2504-M5x16	

HRN Ucuna Uygun. / Compatible with HRN Insert. / Kompatibel mit HRN Wendeplatten.

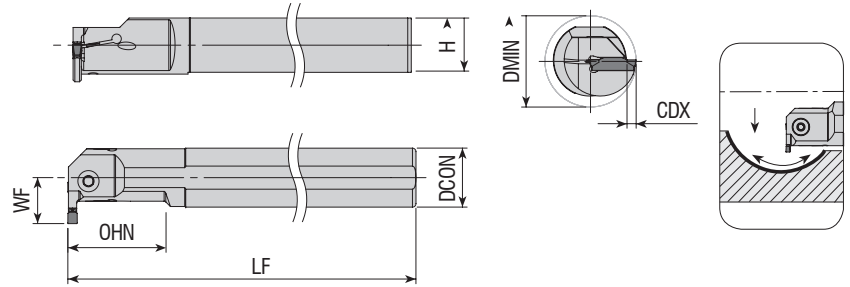

Takım Kodu Ordering Code Bestell-Bezeichnung	Stok Stock Lager		Takım Ölçüleri (mm) Dimension (mm) Abmessung (mm)							Kesici Uç Insert Wendeschneidplatte	Yedek Parçaları / Spare Parts / Ersatzteile	
	R	L	DCON	DMIN	LF	OHN	CDX	H	WF		Sıkma Vidası Screw Schraube	Anahtar Allen Key Innensechskantschlüssel
AIKT-KM-R/L-20-2-T7	●	●	20	25	170	40	7	18.3	13	A4 - 2	2503-M4x12	AAL-03-3
AIKT-KM-R/L-20-3-T7	●	○	20	25	170	40	7	18.3	13		2504-M5x12	AAL-05-4
AIKT-KM-R/L-25-3-T10	●	●	25	32	200	50	10	23	17	A4 - 3	2505-M6x16	AAL-07-5
AIKT-KM-R/L-32-3-T12	●	●	32	40	250	64	12	30	22		2505-M6x20	
AIKT-KM-R/L-40-3-T12	●	●	40	48	300	80	12	37.5	27	A4 - 4	2504-M5x12	AAL-05-4
AIKT-KM-R/L-20-4-T7	●	○	20	25	170	40	7	18.3	13		2504-M5x14	
AIKT-KM-R/L-32-4-T12.2-H	●	○	32	40	190	104	12.2	31	22			

R: Sağ / Right / Rechts L: Sol/Left/Links

● Stokta / In Stock / Auf Lager ○ Stokta Yok / Non Stock Item / Kein Lagerartikel, Lieferzeit auf Anfrage  
KNMTL Ucuna Uygun. / Compatible with KNMTL Insert. / Kompatibel mit KNMTL Wendeplatten.

Sipariş Örneği/Ordering Example/Bestellbeispiel

1 ad./pcs./stück AIKT-HK-R-20-2-T6

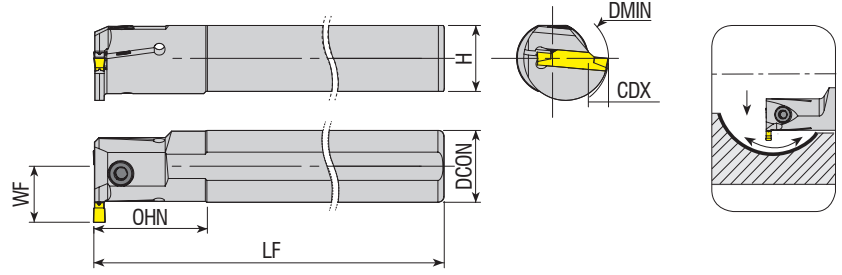

Takım Kodu Ordering Code Bestell-Bezeichnung	Stok Stock Lager		Takım Ölçüleri (mm) Dimension (mm) Abmessung (mm)							Kesici Uç Insert Wendeschneidplatte	Yedek Parçaları / Spare Parts / Ersatzteile			
	R	L	DCON	DMIN	LF	OHN	CDX	H	WF		Sıkma Vidası Screw Schraube	Anahtar Allen Key Innerschlüssel		
AIKT-123-R/L-20-2-T6	●	○	20	32	170	30	6	18.3	16	123 - 2			AAL-03-3	
AIKT-123-R/L-25-2-T6	●	○	25	32	200	40	6	18.3	18.5					2503-M4x12
AIKT-123-R/L-32-2-T7	●	○	32	41	250	45	7	30	23					2004-M8x1x20
AIKT-123-R/L-20-3-T6	●	○	20	32	170	30	6	18.3	16	123 - 3			AAL-05-4	
AIKT-123-R/L-25-3-T7	●	○	25	32	200	40	7	23	19.5					2504-M5x16
AIKT-123-R/L-32-3-T9	●	○	32	41	250	50	9	30	25					2004-M8x1x20
AIKT-123-R/L-20-4-T8	●	○	20	29	170	30	8	18.3	18	123 - 4			AAL-05-4	
AIKT-123-R/L-25-4-T7	●	○	25	32	200	40	7	23	19.5					2504-M5x16
AIKT-123-R/L-32-4-T7	●	○	32	41	250	45	7	30	23					2004-M8x1x20
AIKT-123-R/L-32-4-T10	●	○	32	43	250	50	10	30	26	123 - 5			AAL-05-4	
AIKT-123-R/L-25-5-T8	●	○	25	34	200	40	8	23	20.5					2504-M5x16
AIKT-123-R/L-32-5-T11	●	●	32	43	250	50	11	30	27	2004-M8x1x20				

SNDVK Ucuna Uygundur. / Compatible with SNDVK Insert. / Kompatibel mit SNDVK Wendepplatten.

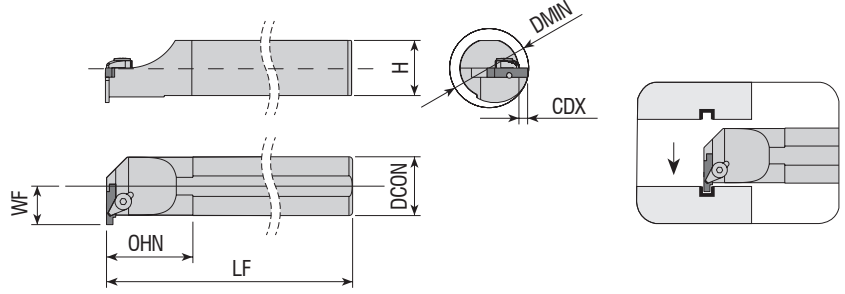

Takım Kodu Ordering Code Bestell-Bezeichnung	Stok Stock Lager		Takım Ölçüleri (mm) Dimension (mm) Abmessung (mm)							Kesici Uç Insert Wendeschneidplatte	Yedek Parçaları / Spare Parts / Ersatzteile						
	R	L	DCON	DMIN	LF	OHN	CDX	H	WF		Baskı Parçası Wedge Clamp Spannpratze	Sıkma Vidası Screw Schraube	Pim Pin Stift	Anahtar Allen Key Innerschlüssel			
AIKT-154.91-R/L-16-3-T3	●	●	16	20	150	35	3	14.8	11	154.91 - 3				APM-06	AAL-05-4		
AIKT-154.91-R/L-20-3-T4	●	●	20	25	170	38	4	18.3	14							ACK-06	AKV-10-M6x14
AIKT-154.91-R/L-25-3-T4	●	●	25	31	200	40	4	23	16.5							ACK-03	AKV-21-M6x18
AIKT-154.91-R/L-25-5-T5	●	●	25	31	200	45	5	23	17.5	154.91 - 5				APM-06	AAL-03-3		
AIKT-154.91-R/L-32-5-T5	●	●	32	38	250	50	5	30	21							ACK-03	AKV-07-M6x22

R: Sağ / Right / Rechts L: Sol/Left/Links

● Stokta / In Stock / Auf Lager ○ Stokta Yok / Non Stock Item / Kein Lagerartikel, Lieferzeit auf Anfrage

SNDVK Ucuna Uygundur. / Compatible with SNDVK Insert. / Kompatibel mit SNDVK Wendepplatten.

Sipariş Örneği/Ordering Example/Bestellbeispiel

1 ad./pcs./stück AIKT-123-R-20-2-T6

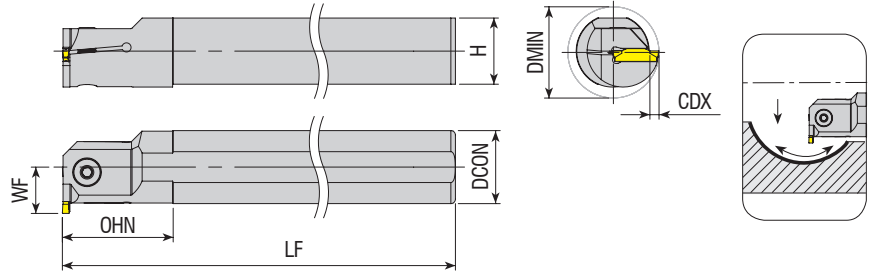

**Takım Kodu**  
**Ordering Code**  
**Bestell-Bezeichnung**

Stok Stock Lager	Takım Ölçüleri (mm) Dimension (mm) Abmessung (mm)									Kesici Uç Insert Wendeschneidplatte	Yedek Parçaları / Spare Parts / Ersatzteile		
	R	L	DCON	DMIN	LF	OHN	CDX	H	WF		Sıkma Vidası Screw Schraube	Anahtar Allen Key Innensechskantschlüssel	
●	○	16	24	150	28	6	14.8	14	RD.-2		AAL-03-3		
●	○	20	28	170	28	6	18.3	16					
●	○	25	33	200	28	6	23	18.5					
●	○	16	24	150	28	6	14.8	14	RD.-3		AAL-05-4		
●	○	20	28	170	28	6	18.3	16					
●	○	25	33	200	28	6	23	18.5					
●	○	32	40	250	50	6	30	22	RD.-4		AAL-05-4		
●	○	20	28	170	28	6	18.3	16					
●	○	25	33	200	28	6	23	18.5					
●	○	32	40	250	50	6	30	22					

TGTC Ucuna Uygundur. / Compatiple with TGTC Insert. / Kompatibel mit TGTC Wendeplatten.

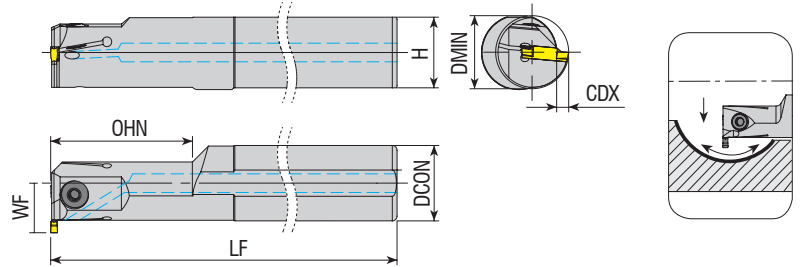

**Takım Kodu**  
**Ordering Code**  
**Bestell-Bezeichnung**

Stok Stock Lager	Takım Ölçüleri (mm) Dimension (mm) Abmessung (mm)									Kesici Uç Insert Wendeschneidplatte	Yedek Parçaları / Spare Parts / Ersatzteile		
	R	L	DCON	DMIN	LF	OHN	CDX	H	WF		Sıkma Vidası Screw Schraube	Anahtar Allen Key Innensechskantschlüssel	
●	○	16	25	150	28	8.5	14.8	16.5	TD.-2		AAL-03-3		
●	○	20	25	170	40	6	18.3	16	TD.-3		AAL-05-4		
●	○	25	25	200	40	6	23	18.5					
●	○	32	31	250	60	5	30	21					

R: Sağ / Right / Rechts L: Sol/Left/Links  
● Stokta / In Stock / Auf Lager ○ Stokta Yok / Non Stock Item / Kein Lagerartikel, Lieferzeit auf Anfrage  
TGTC Ucuna Uygundur. / Compatiple with TGTC Insert. / Kompatibel mit TGTC Wendeplatten.

Sipariş Örneği/Ordering Example/Bestellbeispiel  
1 ad./pcs./stück AIKT-RD-R-16-2-T6

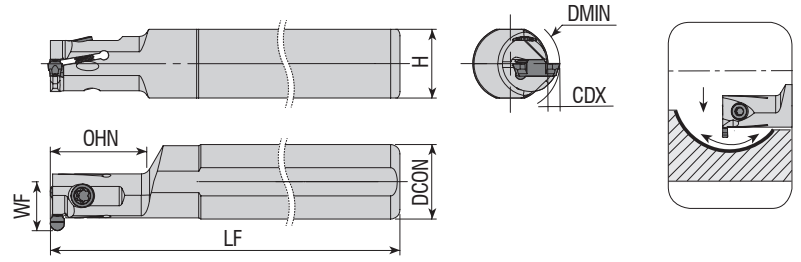

Takım Kodu Ordering Code Bestell-Bezeichnung	Stok Stock Lager		Takım Ölçüleri (mm) Dimension (mm) Abmessung (mm)							Kesici Uç Insert Wendeschneidplatte	Yedek Parçaları / Spare Parts / Ersatzteile	
	R	L	DCON	DMIN	LF	OHN	CDX	H	WF		Sıkma Vidası Screw Schraube	Tork Anahtar Torx Key Torx-Schlüssel
AIKT-IGE-R/L-10-2-T3-H	●	○	10	11.5	125	25	3	9	8.3	GEPI - 2	3008-M3x8	80-T08
AIKT-IGE-R/L-16-2-T3-D11.5	●	○	16	11.5	125	20	3	14.8	11.1			
AIKT-IGE-R/L-16-2-T2.5-H	●	●	16	13	125	20	2.5	14.8	10.5			
AIKT-IGE-R/L-16-3-T2.5-H	●	○	16	13	125	20	2.5	14.8	10.5	GEPI - 3	1315-M4x11	80-T15
AIKT-IGE-R/L-16-3-T2.5-D20	●	○	16	20	125	28	2.5	14.8	10.5			

ISCR Ucuna Uygundur. / Compatible with ISCR Insert. / Kompatibel mit ISCR Wendepfetten.

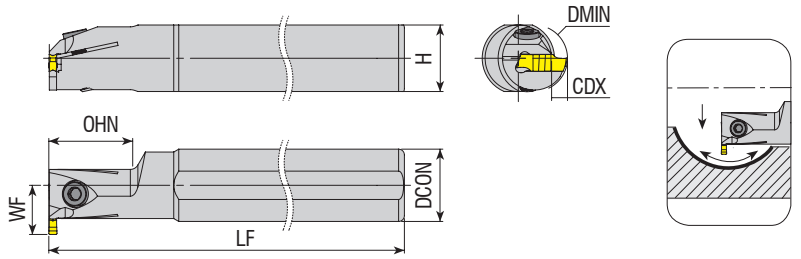

Takım Kodu Ordering Code Bestell-Bezeichnung	Stok Stock Lager		Takım Ölçüleri (mm) Dimension (mm) Abmessung (mm)							Kesici Uç Insert Wendeschneidplatte	Yedek Parçaları / Spare Parts / Ersatzteile	
	R	L	DCON	DMIN	LF	OHN	CDX	H	WF		Sıkma Vidası Screw Schraube	Tork Anahtar Torx Key Torx-Schlüssel
AIKT-IGI-R/L-20-3-T4	●	●	20	20	170	25	4	18.3	14.5	GIMIY / GIPI - 3	1020-M5x14	80-T20
AIKT-IGI-R/L-25-3-T5	●	●	25	23	200	30	5	23	17		2504-M5x16	
AIKT-IGI-R/L-32-3-T5	●	●	32	31	250	30	5	30	21		2004-M8x1x20	AAL-05-4
AIKT-IGI-R/L-40-3-T5	●	○	40	50	300	50	5	37.5	25	GIMIY / GIPI - 4	1020-M5x14	80-T20
AIKT-IGI-R/L-20-4-T4	●	●	20	20	170	25	4	18.3	14.5	GIMIY / GIPI - 5	2504-M5x16	AAL-05-4
AIKT-IGI-R/L-25-5-T10	●	○	25	32	200	25	10	23	22.5			
AIKT-IGI-R/L-25-5-T15	●	○	25	37	200	25	15	23	27.5			

R: Sağ / Right / Rechts L: Sol/Left/Links

● Stokta / In Stock / Auf Lager ○ Stokta Yok / Non Stock Item / Kein Lagerartikel, Lieferzeit auf Anfrage

ISCR Ucuna Uygundur. / Compatible with ISCR Insert. / Kompatibel mit ISCR Wendepfetten.

Sipariş Örneği/Ordering Example/Bestellbeispiel

1 ad./pcs./stück AIKT-IGE-R-10-2-T3-H

Not: "OHN" boyları D min çapa göre verilmiştir.

Note: Lengths of "OHN" are given according to D min diameter.

Hinweis: Maß "OHN" soll identisch mit Dmin sein



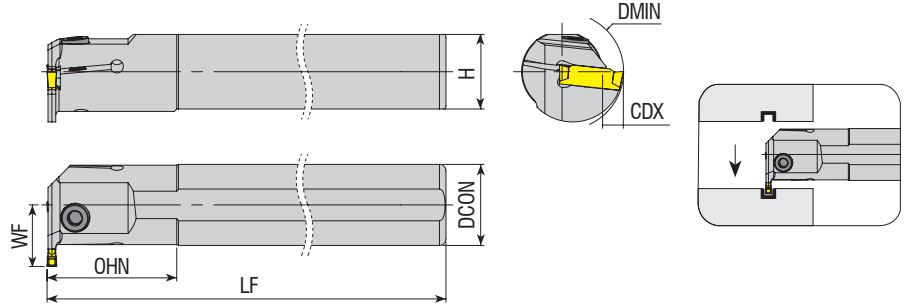

Takım Kodu Ordering Code Bestell-Bezeichnung	Stok Stock Lager		Takım Ölçüleri (mm) Dimension (mm) Abmessung (mm)							Kesici Uç Insert Wendeschneidplatte	Yedek Parçaları / Spare Parts / Ersatzteile	
	R	L	DCON	DMIN	LF	OHN	CDX	H	WF		Sıkma Vidası Screw Schraube	Anahtar Allen Key Innensechskantschlüssel
AIKT-I-R/L-20-3-T5	●	●	20	26	170	25	5	18.3	15.5	DGN - 3	2504-M5x12	AAL-05-4
AIKT-I-R/L-25-3-T6	●	●	25	32	200	40	6	23	19		2504-M5x16	

ISCR Ucuna Uygundur. / Compatible with ISCR Insert. / Kompatibel mit ISCR Wendeplatten.

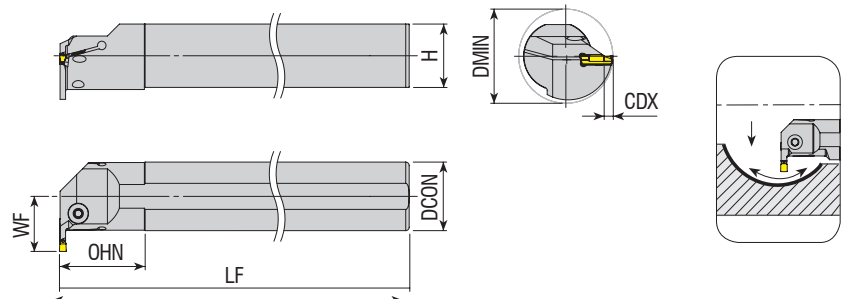

Takım Kodu Ordering Code Bestell-Bezeichnung	Stok Stock Lager		Takım Ölçüleri (mm) Dimension (mm) Abmessung (mm)							Kesici Uç Insert Wendeschneidplatte	Yedek Parçaları / Spare Parts / Ersatzteile	
	R	L	DCON	DMIN	LF	OHN	CDX	H	WF		Sıkma Vidası Screw Schraube	Anahtar Allen Key Innensechskantschlüssel
AIKT-IG-R/L-25-4-T10-H	●	●	25	36	200	40	10	23	22.7	DGN / GRP - 4	2504-M5X16	AAL-05-4
AIKT-IG-R/L-32-4-T10-H	●	●	32	43	250	45	10	30	26.2		2004-M8x1x20	
AIKT-IG-R/L-40-4-T12-H	●	●	40	53	250	50	12	37.5	32.2			
AIKT-IG-R/L-25-5-T10-H	●	○	25	36	200	40	10	23	22.7	DGN / GRP - 5	2504-M5X16	
AIKT-IG-R/L-32-5-T10-H	●	○	32	43	250	45	10	30	26.2		2004-M8x1x20	
AIKT-IG-R/L-40-5-T12-H	●	○	40	53	250	50	12	37.5	32.2			
AIKT-IG-R/L-50-5-T12-H	●	○	50	63	300	60	12	47	37.2			

R: Sağ / Right / Rechts L: Sol/Left/Links

● Stokta / In Stock / Auf Lager ○ Stokta Yok / Non Stock Item / Kein Lagerartikel, Lieferzeit auf Anfrage  
ISCR Ucuna Uygundur. / Compatible with ISCR Insert. / Kompatibel mit ISCR Wendeplatten.

Sipariş Örneği/Ordering Example/Bestellbeispiel  
1 ad./pcs./stück AIKT-I-R-20-3-T5

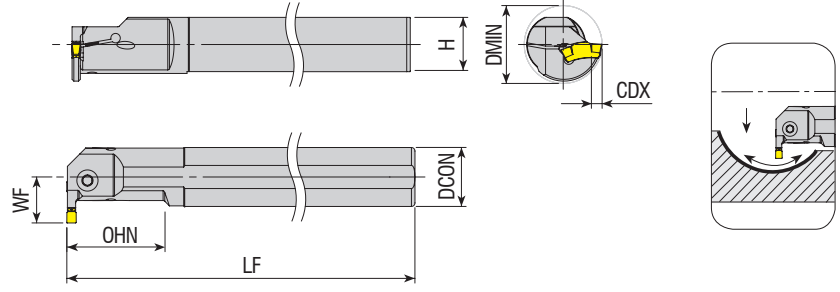

Takım Kodu Ordering Code Bestell-Bezeichnung	Stok Stock Lager		Takım Ölçüleri (mm) Dimension (mm) Abmessung (mm)							Kesici Uç Insert Wendeschneidplatte	Yedek Parçaları / Spare Parts / Ersatzteile		
	R	L	DCON	DMIN	LF	OHN	CDX	H	WF		Sıkma Vidası Screw Schraube	Tork Anahtar Torx Key	Anahtar Allen Key
AIKT-ITG-R/L-16-3-T6-H	●	●	16	20	150	25	6	14.8	12	TGM. - 3	1020-M4.5X14	80-T20	
AIKT-ITG-R/L-20-3-T6-H	●	●	20	25	170	32	6	18.3	14.2		1020-M4.5X16		
AIKT-ITG-R/L-25-3-T8-H	●	●	25	32	200	40	8	23	18.8		2504-M5X16	AAL-05-4	
AIKT-ITG-R/L-32-3-T8-H	●	●	32	38	250	49	8	30	22		2004-M8x1x20		
AIKT-ITG-R/L-20-4-T6-H	●	●	20	25	170	33	6	18.3	14.2	TGM. - 4	1020-M4.5X16	80-T20	
AIKT-ITG-R/L-25-4-T7-H	●	●	25	31	200	41	7	23	17.5		2504-M5X16	AAL-05-4	
AIKT-ITG-R/L-25-4-T9-H	●	●	25	32.5	200	41	9	23	19.5				
AIKT-ITG-R/L-32-4-T11-H	●	●	32	42	250	50	11	30	25.5				
AIKT-ITG-R/L-40-4-T11-H	●	●	40	53	300	50	11	37.5	32	TGM. - 6.35	2004-M8x1x20		
AIKT-ITG-R/L-32-6.35-T17.5-H	●	●	32	57	250	50	17.5	30	29				

ISCR Ucuna Uygun. / Compatible with ISCR Insert. / Kompatibel mit ISCR Wendeschneidplatten.

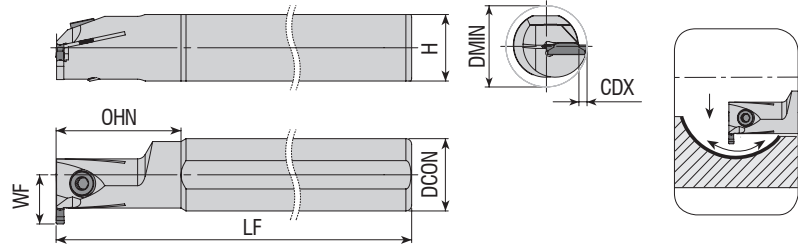

Takım Kodu Ordering Code Bestell-Bezeichnung	Stok Stock Lager		Takım Ölçüleri (mm) Dimension (mm) Abmessung (mm)							Kesici Uç Insert Wendeschneidplatte	Yedek Parçaları / Spare Parts / Ersatzteile	
	R	L	DCON	DMIN	LF	OHN	CDX	H	WF		Sıkma Vidası Screw Schraube	Anahtar Allen Key
AIKT-GP-R/L-20-2-T4	●	○	20	25	170	30	4	18.3	14.5	GP - 2	2503-M4x12	AAL-03-3
AIKT-GP-R/L-25-2-T6	●	○	25	32	200	40	6	23	18.5			
AIKT-GP-R/L-20-3-T6	●	○	20	27	170	30	6	18.3	16	GP - 3	2504-M5X16	AAL-05-4
AIKT-GP-R/L-25-3-T6	●	○	25	32	200	40	6	23	18.5			
AIKT-GP-R/L-32-3-T6	●	○	32	39	250	50	6	30	22	GP - 4	2004-M8x1x20	
AIKT-GP-R/L-20-4-T6	●	○	20	27	170	30	6	18.3	16		2504-M5X16	
AIKT-GP-R/L-25-4-T6	●	○	25	32	200	40	6	23	18.5		2004-M8x1x20	
AIKT-GP-R/L-32-4-T6	●	○	32	39	250	50	6	30	22			

R: Sağ / Right / Rechts L: Sol/Left/Links  
● Stokta / In Stock / Auf Lager ○ Stokta Yok / Non Stock Item / Kein Lagerartikel, Lieferzeit auf Anfrage  
PLBT Ucuna Uygun. / Compatible with PLBT Insert. / Kompatibel mit PLBT Wendeschneidplatten.

Sipariş Örneği/Ordering Example/Bestellbeispiel  
1 ad./pcs./stück AIKT-ITG-R-16-3-T6-H

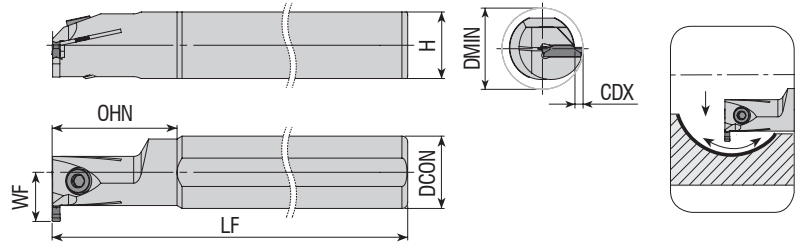

**Takım Kodu**  
**Ordering Code**  
**Bestell-Bezeichnung**

Takım Kodu Ordering Code Bestell-Bezeichnung	Stok Stock Lager		Takım Ölçüleri (mm) Dimension (mm) Abmessung (mm)							Kesici Uç Insert Wendeschneidplatte	Yedek Parçaları / Spare Parts / Ersatzteile	
	R	L	DCON	DMIN	LF	OHN	CDX	H	WF		Sıkma Vidası Screw Schraube	Tork Anahtar Torx Key Torx-Schlüssel
AIKT-TG-R/L-20-2-T6	●	○	20	28	160	28	6	18.3	15.8	DGIM2-020	2503-M4x10	AAL-03-3
AIKT-TG-R/L-20-3-T6	●	○	20	28	160	28	6	18.3	15.8	DTX3-030	2504-M5x12	AAL-05-4
AIKT-TG-R/L-25-3-T8	●	○	25	35	200	28	8	23	21.5		2504-M5x16	
AIKT-TG-R/L-32-3-T10	●	○	32	43	250	50	10	30	27	2004-M8x1x20		
AIKT-TG-R/L-32-3-T12	●	○	32	45	250	50	12	30	27			
AIKT-TG-R/L-32-4-T10	●	○	32	43	250	50	10	30	27			
AIKT-TG-R/L-32-5-T10	●	○	32	43	250	50	10	30	27	DTX4-040		
										DTX5-040		

TNGLY Ucuna Uygun. / Compatiple with TNGLY Insert. / Kompatibel mit TNGLY Wendeplatten.

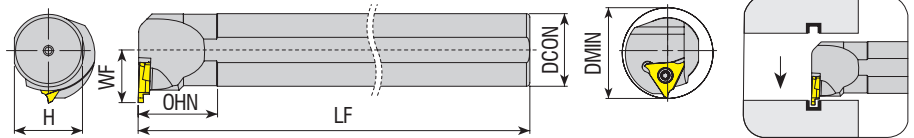

**Takım Kodu**  
**Ordering Code**  
**Bestell-Bezeichnung**

Takım Kodu Ordering Code Bestell-Bezeichnung	Stok Stock Lager		Takım Ölçüleri (mm) Dimension (mm) Abmessung (mm)							Kesici Uç Insert Wendeschneidplatte	Yedek Parçaları / Spare Parts / Ersatzteile	
	R	L	DCON	DMIN	LF	OHN	CDX	H	WF		Sıkma Vidası Screw Schraube	Anahtar Allen Key Innensechskantschlüssel
AIKT-QC11R/L-20-(0.5-1.8)	●	○	20	16	150	40	-	18.3	12	QC11R/L (0.50-1.80)	3008 M2.5x6	80-T08
AIKT-QC16R/L-20-(0.5-1.8)	○	○	20	25	150	35	-	18.3	13.5	QC16R/L (0.50-1.80)	4015-M3.5x10	80-T15
AIKT-QC16R/L-20-(0.5-2.5)	●	○	20	25	150	35	-	18.3	13.5	QC16R/L (0.50-2.50)		
AIKT-QC22R/L-25-(1-2.3)	○	○	25	35	150	35	-	23	18.2	QC22R/L (1.00-2.30)	1020 M5x11	80-T20
AIKT-QC22R/L-25-(2.5-3.3)	●	○	25	35	150	35	-	23	18.2	QC22R/L (2.50-3.30)		
AIKT-QC22R/L-25-(3.3-4.8)	●	○	25	35	150	35	-	23	18.2	QC22R/L (3.30-4.80)		
AIKT-QC22R/L-32-(1-2.3)	○	○	32	45	150	35	-	30	23.2	QC22R/L (1.00-2.30)		

R: Sağ / Right / Rechts L: Sol/Left/Links

● Stokta / In Stock / Auf Lager ○ Stokta Yok / Non Stock Item / Kein Lagerartikel, Lieferzeit auf Anfrage

ZCC Ucuna Uygun. / Compatiple with ZCC Insert. / Kompatibel mit ZCC Wendeplatten.

Sipariş Örneği/Ordering Example/Bestellbeispiel

1 ad./pcs./stück AIKT-TG-R-20-2-T6

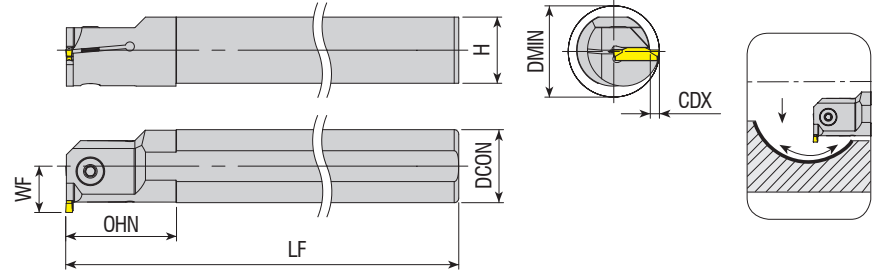

Takım Kodu Ordering Code Bestell-Bezeichnung	Stok Stock Lager		Takım Ölçüleri (mm) Dimension (mm) Abmessung (mm)							Kesici Uç Insert Wendeschneidplatte	Yedek Parçaları / Spare Parts / Ersatzteile	
	R	L	DCON	DMIN	LF	OHN	CDX	H	WF		Sıkma Vidası Screw Schraube	Anahtar Allen Key Innerschlüssel
AIKT-ZCC2-R/L-16-2-T4	●	○	16	21	150	28	4	14.8	12	Z.BD - 2	2503-M4x10	AAL-03-3
AIKT-ZCC2-R/L-20-3-T5	●	●	20	27	170	30	5	18.3	15		Z.FD - 3	
AIKT-ZCC2-R/L-20-3-T8	●	○	20	29	170	30	8	18.3	18	2504-M5x16		
AIKT-ZCC2-R/L-25-3-T5	●	○	25	31	200	40	5	23	17.5	2004-M8x1x20		
AIKT-ZCC2-R/L-25-3-T10	●	○	25	36	200	40	10	23	22.5	2504-M5x12		
AIKT-ZCC2-R/L-32-3-T6	●	○	32	39	250	50	6	30	22	2504-M5x16		
AIKT-ZCC2-R/L-32-3-T8	●	○	32	41	250	50	8	30	24	2004-M8x1x20		
AIKT-ZCC2-R/L-32-3-T13	●	○	32	46	250	50	13	30	29			
AIKT-ZCC2-R/L-40-3-T12	●	○	40	53	300	55	12	37.5	32	Z.GD - 4		2504-M5x12
AIKT-ZCC2-R/L-25-4-T6	●	○	25	32	200	40	6	23	18.5		2504-M5x16	
AIKT-ZCC2-R/L-32-4-T7	●	○	32	40	250	50	7	30	23	Z.HD - 5	2004-M8x1x20	
AIKT-ZCC2-R/L-32-4-T8	●	○	32	41	250	50	8	30	24			
AIKT-ZCC2-R/L-32-4-T10	●	○	32	43	250	50	10	30	26			
AIKT-ZCC2-R/L-32-5-T7	●	○	32	40	250	50	7	30	23			
AIKT-ZCC2-R/L-32-5-T8	●	○	32	41	250	50	8	30	24			
AIKT-ZCC2-R/L-40-5-T8	●	○	40	49	300	55	8	37.5	28			
AIKT-ZCC2-R/L-40-5-T10	●	○	40	51	300	55	10	37.5	30			

ZCC Ucuna Uygundur. / Compatible with ZCC Insert. / Kompatibel mit ZCC Wendepplatten.

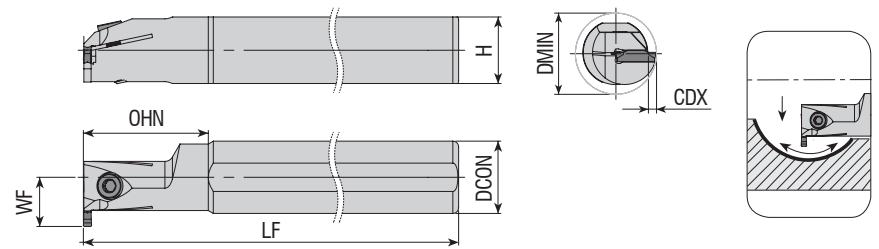

Takım Kodu Ordering Code Bestell-Bezeichnung	Stok Stock Lager		Takım Ölçüleri (mm) Dimension (mm) Abmessung (mm)							Kesici Uç Insert Wendeschneidplatte	Yedek Parçaları / Spare Parts / Ersatzteile	
	R	L	DCON	DMIN	LF	OHN	CDX	H	WF		Sıkma Vidası Screw Schraube	Anahtar Allen Key Innerschlüssel
AIKT-SGC-R/L-25-3-T6	●	○	25	32	200	40	6	23	18.5	GCM N30	2504-M5x16	AAL-05-4
AIKT-SGC-R/L-32-3-T6	●	○	32	39	250	50	6	30	22		2004-M8x1x20	
AIKT-SGC-R/L-40-3-T6	●	○	40	47	300	55	6	37.5	26			

R: Sağ / Right / Rechts L: Sol/Left/Links

● Stokta / In Stock / Auf Lager ○ Stokta Yok / Non Stock Item / Kein Lagerartikel, Lieferzeit auf Anfrage  
SMTM Ucuna Uygundur. / Compatible with SMTM Insert. / Kompatibel mit SMTM Wendepplatten.

Sipariş Örneği/Ordering Example/Bestellbeispiel

1 ad./pcs./stück AIKT-ZCC2-R-16-2-T4



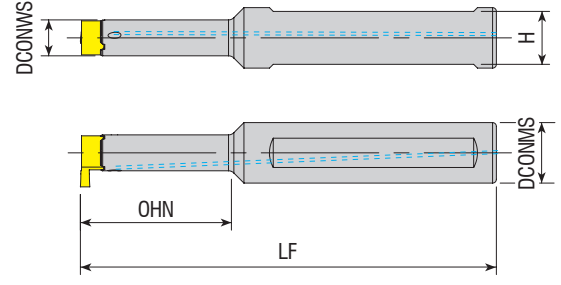

**Takım Kodu**  
**Ordering Code**  
**Bestell-Bezeichnung**

AIKT-MB07-A16-090-15  
AIKT-MB07-A16-090-22  
AIKT-MB09-A16-090-19  
AIKT-MB09-A16-095-28  
AIKT-MB09-A16-110-40

Stok  
Stock  
Lager

Takım Ölçüleri (mm)  
Dimension (mm)  
Abmessung (mm)

Kesici Uç  
Insert  
Wendeschneidplatte

Yedek Parçaları / Spare Parts / Ersatzteile

Sıkma Vidası  
Screw  
Schraube

Anahtar  
Allen Key  
Innensechskantschlüssel

	DCONMS	DCONWS	LF	OHN	H
AIKT-MB07-A16-090-15	16	7.4	90	15	14
AIKT-MB07-A16-090-22	16	7.4	90	22	14
AIKT-MB09-A16-090-19	16	9.5	90	19	14
AIKT-MB09-A16-095-28	16	9.5	95	28	14
AIKT-MB09-A16-110-40	16	9.5	110	40	14



MB - 07

4008-M3x8

80-T08

MB - 09

4015-M4x11

80-T15

R: Sağ / Right / Rechts L: Sol/Left/Links

● Stokta / In Stock / Auf Lager ○ Stokta Yok / Non Stock Item / Kein Lagerartikel, Lieferzeit auf Anfrage  
SNDVK Ucuna Uygunudur. / Compatible with SNDVK Insert. / Kompatibel mit SNDVK Wendeplatten.

Sipariş Örneği/Ordering Example/Bestellbeispiel  
1 ad./pcs./stück AIKT-MB07-A16-090-15



**konusulan**  
the spoken **kalite...**  
quality...





**DELİK DELME ve İŞLEME TAKIMLARI**  
*DRILLING and HOLEMAKING TOOLS*  
*BOHRWERKZEUGE*







*konusulan  
the spoken kalite...  
quality...*

# U-DRILL

TAKMA UÇLU MATKAPLAR  
U-DRILL SYSTEM  
VOLLBOHRER

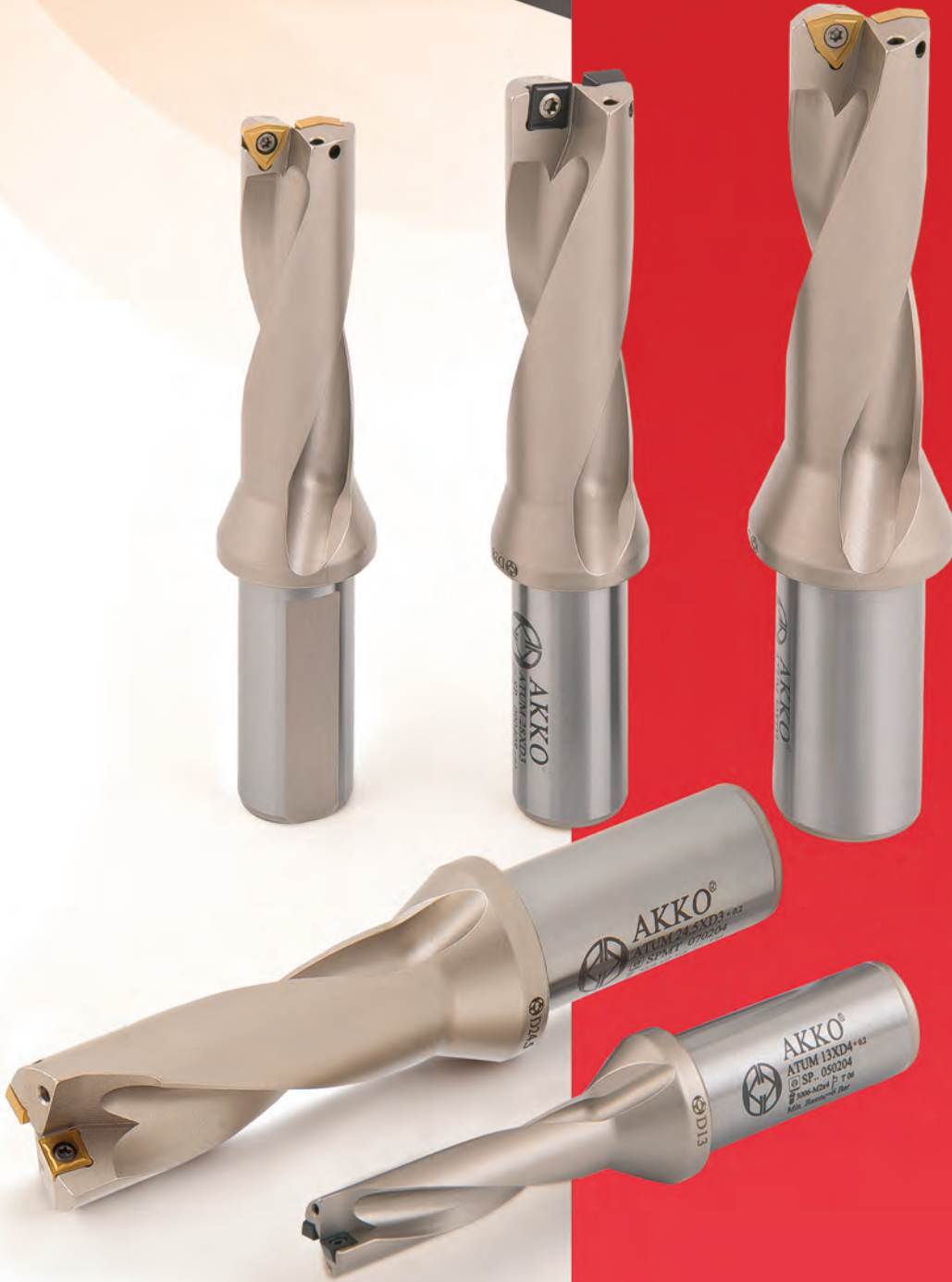





**AKKO** **A** **TUM** **16** x **D3**

**S** **P** **G** **T** **06** **02** **04**

**2** Kesici Stili / Cutter Style  
Werkzeugtyp

TUM: Takma Uçlu Matkap  
U-Drill  
Vollbohrer

**3** Takım Çapı / Tool Diameter  
Werkzeugdurchmesser

**4** Delme Derinliği / Drilling Depth  
Bohrtiefe

**5** Uç Şekli / Insert Form  
Plattenform

**W** **S**

**6** Serbest Uç Açısı / Clearance angle of Insert  
Freiwinkel der Wendschneidplatte

**C** **P**

**8** Uç Tipi / Insert Type  
Plattentyp

A J T   
 $\beta = 70-90^\circ$   $\beta = 70-90^\circ$   $\beta = 40-60^\circ$

B M U   
 $\beta = 70-90^\circ$   $\beta = 40-60^\circ$   $\beta = 40-60^\circ$

C N W   
 $\beta = 70-90^\circ$   $\beta = 40-60^\circ$   $\beta = 40-60^\circ$

F Q X Özel  
Special  
Sonder

G R

H

$\beta = 70-90^\circ$

**10** Kalınlık / Thickness  
Dicke

01 s = 1.59  
T1 s = 1.98  
02 s = 2.38  
T2 s = 2.78  
03 s = 3.18  
T3 s = 3.97  
04 s = 4.76  
05 s = 5.56  
06 s = 6.35  
07 s = 7.94  
09 s = 9.52

**7** Toleranslar / Tolerance Classes  
Toleranzen

	IC	M	S
A	± 0.025	± 0.005	± 0.025
C	± 0.025	± 0.013	± 0.025
E	± 0.025	± 0.025	± 0.025
F	± 0.013	± 0.005	± 0.025
G	± 0.025	± 0.025	± 0.130
H	± 0.013	± 0.013	± 0.025
J	± 0.05-0.15	± 0.005	± 0.025
K	± 0.05-0.15	± 0.013	± 0.025
L	± 0.05-0.15	± 0.025	± 0.025
M	± 0.05-0.15	± 0.08-0.20	± 0.130
N	± 0.05-0.15	± 0.08-0.20	± 0.025
U	± 0.08-0.25	± 0.13-0.38	± 0.130

IC : Daire Ölçüsü / Inscribed Circle / Kreisgröße  
M : Şekle Göre / Refer to Figure / Siehe Abbildung  
S : Kalınlık / Thickness / Dicke

**9** Kesme Kenar Uzunluğu / Cutting Edge Length  
Schneidkantenlänge

**11** Köşe Konfigürasyonu / Corner Radius  
Eckenradius

01 r = 0.1  
02 r = 0.2  
04 r = 0.4  
08 r = 0.8  
12 r = 1.2  
16 r = 1.6  
24 r = 2.4



Delme Derinliği  
Drilling Depth  
Bohrtiefe

= 2xÇap  
= 2xDiameter  
= 2xDurchmesser

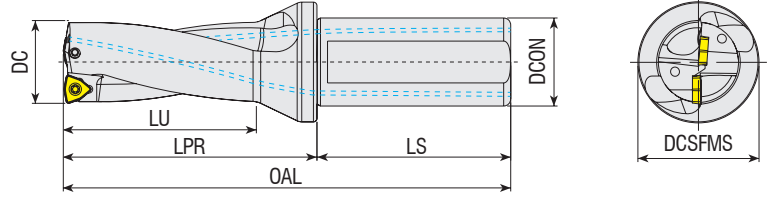

**Takım Kodu**  
**Ordering Code**  
**Bestell-Bezeichnung**

Stok  
Stock  
Lager

Takım Ölçüleri (mm)  
Dimension (mm)  
Abmessung (mm)

Maks. Ofset (radyal)  
Max. Offset (radial)  
Max. Versatz (radial)

Kesici Uç  
Insert  
Wendeschneidplatte

Yedek Parçaları / Spare Parts / Ersatzteile

Sıkma Vidası  
Screw  
Schraube

Tork Anahtar  
Torx Key  
Torx-Schlüssel

DC DCON DCSFMS OAL LU LPR LS

X<sub>max</sub>  
X<sub>max</sub>[mm] DC<sub>max</sub>[mm]

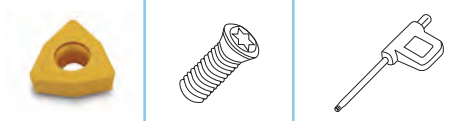

Takım Kodu Ordering Code Bestell-Bezeichnung	Stok Stock Lager	DC	DCON	DCSFMS	OAL	LU	LPR	LS	Maks. Ofset (radyal) Max. Offset (radial) Max. Versatz (radial)	Kesici Uç Insert Wendeschneidplatte	Sıkma Vidası Screw Schraube	Tork Anahtar Torx Key Torx-Schlüssel
ATUM 16XD2 WCM. 030208	●	16	25	34	110	32	54	56	1.5	19	WCM. 030208	3008-M2.5x6
ATUM 16.5XD2 WCM. 030208	●	16.5	25	34	110	32	54	56	1.5	19.5		
ATUM 17XD2 WCM. 030208	●	17	25	34	112	34	56	56	1.5	20		
ATUM 17.5XD2 WCM. 030208	●	17.5	25	34	112	34	56	56	1.5	20.5		
ATUM 18XD2 WCM. 030208	●	18	25	34	114	36	58	56	1.4	20.8		
ATUM 18.5XD2 WCM. 030208	●	18.5	25	34	114	36	58	56	1.3	21.1		
ATUM 19XD2 WCM. 030208	●	19	25	34	116	38	60	56	1.2	21.4		
ATUM 19.5XD2 WCM. 030208	●	19.5	25	34	116	38	60	56	1.2	21.9		
ATUM 20XD2 WCM. 040208	●	20	25	34	118	40	62	56	1.4	22.8	WCM. 040208	3008-M2.5x6
ATUM 20.5XD2 WCM. 040208	●	20.5	25	34	118	40	62	56	1.4	23.3		
ATUM 21XD2 WCM. 040208	●	21	25	34	120	42	64	56	1	23		
ATUM 21.5XD2 WCM. 040208	●	21.5	25	34	120	42	64	56	1	23.5		
ATUM 22XD2 WCM. 040208	●	22	25	34	122	44	66	56	0.9	23.8		
ATUM 22.5XD2 WCM. 040208	●	22.5	25	34	122	44	66	56	0.9	24.3		
ATUM 23XD2 WCM. 040208	●	23	25	34	124	46	68	56	0.8	24.6		
ATUM 23.5XD2 WCM. 040208	●	23.5	25	34	124	46	68	56	0.8	25.1		
ATUM 24XD2 WCM. 050308	●	24	25	34	126	48	70	56	1.4	26.8	WCM. 050308	3008-M3x8
ATUM 24.5XD2 WCM. 050308	●	24.5	25	34	126	48	70	56	1.4	27.3		
ATUM 25XD2 WCM. 050308	●	25	25	34	128	50	72	56	1.4	27.8		
ATUM 25.5XD2 WCM. 050308	●	25.5	25	34	128	50	72	56	1.4	28.3		
ATUM 26XD2 WCM. 050308	●	26	25	34	130	52	74	56	1.4	28.8		
ATUM 26.5XD2 WCM. 050308	●	26.5	25	34	130	52	74	56	1.4	29.3		
ATUM 27XD2 WCM. 050308	●	27	25	34	132	54	76	56	1.4	29.8		
ATUM 27.5XD2 WCM. 050308	●	27.5	25	34	132	54	76	56	1.4	30.3		
ATUM 28XD2 WCM. 050308	●	28	25	34	134	56	78	56	1.4	30.8		
ATUM 28.5XD2 WCM. 050308	●	28.5	25	34	134	56	78	56	1.4	31.3		
ATUM 29XD2 WCM. 050308	●	29	25	34	136	58	80	56	1.4	31.8		
ATUM 29.5XD2 WCM. 050308	●	29.5	25	34	136	58	80	56	1.4	32.3		

R: Sağ / Right / Rechts L: Sol/Left/Links

● Stokta / In Stock / Auf Lager ○ Stokta Yok / Non Stock Item / Kein Lagerartikel, Lieferzeit auf Anfrage  
ISO Ucuna Uygundur. / Compatible with ISO Insert. / Kompatibel mit ISO Wendeplatten.

Sipariş Örneği/Ordering Example/Bestellbeispiel

1 ad./pcs./stück ATUM 16XD2 WCM. 030208

Takma Uçlu Matkap Kullanım Kılavuzu : S 365 / User's Guide For U-Drills : P 365

S.366 Bedienungsanleitung für Vollbohrer



Delme Derinliği  
Drilling Depth  
Bohrtiefe

= 2xÇap  
= 2xDiameter  
= 2xDurchmesser

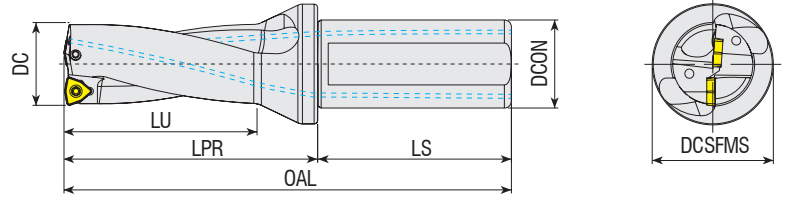

**Takım Kodu**  
**Ordering Code**  
**Bestell-Bezeichnung**

Stok Stock Lager	Takım Ölçüleri (mm) Dimension (mm) Abmessung (mm)								Maks. Ofset (radyal) Max. Offset (radial) Max. Versatz (radial)		Kesici Uç Insert Wendeschneidplatte	Yedek Parçaları / Spare Parts / Ersatzteile	
	DC	DCON	DCSFMS	OAL	LU	LPR	LS	X <sub>max</sub>	DC <sub>max</sub> [mm]	Sıkma Vidası Screw Schraube		Tork Anahtar Torx Key Torx-Schlüssel	
ATUM 30XD2 WCM. 06T308	30	32	44	147	60	87	60	2.4	34.8	WCM. 06T308	3010-M3.5x9	80-T10	
ATUM 31XD2 WCM. 06T308	31	32	44	149	62	89	60	2.3	35.6				
ATUM 32XD2 WCM. 06T308	32	32	44	151	64	91	60	2.1	36.2				
ATUM 33XD2 WCM. 06T308	33	32	44	153	66	93	60	1.9	36.8				
ATUM 34XD2 WCM. 06T308	34	32	44	155	68	95	60	1.9	37.8				
ATUM 35XD2 WCM. 06T308	35	32	44	157	70	97	60	1.8	38.6				
ATUM 36XD2 WCM. 06T308	36	32	44	159	72	99	60	1.7	39.4				
ATUM 37XD2 WCM. 06T308	37	32	44	161	74	101	60	1.6	40.2				
ATUM 38XD2 WCM. 06T308	38	32	44	163	76	103	60	1.5	41				
ATUM 39XD2 WCM. 06T308	39	32	44	165	78	105	60	1.3	41.6				
ATUM 40XD2 WCM. 06T308	40	32	44	167	80	107	60	1	42				
ATUM 41XD2 WCM. 06T308	41	32	44	169	82	109	60	0.8	42.6				
ATUM 42XD2 WCM. 06T308	42	32	44	171	84	111	60	0.5	43				
ATUM 43XD2 WCM. 06T308	43	32	44	173	86	113	60	0.3	43.6				
ATUM 44XD2 WCM. 06T308	44	32	44	175	88	115	60	0	44				
ATUM 45XD2 WCM. 080412	45	40	54	192	90	122	70	3.3	51.6	WCM. 080412	4015-M4x11	80-T15	
ATUM 46XD2 WCM. 080412	46	40	54	194	92	124	70	3	52				
ATUM 47XD2 WCM. 080412	47	40	54	196	94	126	70	2.8	52.6				
ATUM 48XD2 WCM. 080412	48	40	54	198	96	128	70	2.5	53				
ATUM 49XD2 WCM. 080412	49	40	54	200	98	130	70	2.2	53.4				
ATUM 50XD2 WCM. 080412	50	40	54	202	100	132	70	2	54				
ATUM 51XD2 WCM. 080412	51	40	54	204	102	134	70	1.8	54.6				
ATUM 52XD2 WCM. 080412	52	40	54	206	104	136	70	1.5	55				
ATUM 53XD2 WCM. 080412	53	40	54	208	106	138	70	1.3	55.6				
ATUM 54XD2 WCM. 080412	54	40	54	210	108	140	70	1	56				
ATUM 55XD2 WCM. 080412	55	40	54	212	110	142	70	0.8	56.6				
ATUM 56XD2 WCM. 080412	56	40	64	214	112	144	70	0.5	57				
ATUM 57XD2 WCM. 080412	57	40	64	216	114	146	70	0.3	57.6				
ATUM 58XD2 WCM. 080412	58	40	64	218	116	148	70	0	58				
ATUM 59XD2 WCM. 080412	59	40	64	220	118	150	70	0	59				
ATUM 60XD2 WCM. 080412	60	40	64	222	120	152	70	0	60				

R: Sağ / Right / Rechts L: Sol/Left/Links

● Stokta / In Stock / Auf Lager ○ Stokta Yok / Non Stock Item / Kein Lagerartikel, Lieferzeit auf Anfrage  
ISO Ucuna Uygunudur. / Compatible with ISO Insert. / Kompatibel mit ISO Wendeplatten.

Sipariş Örneği/Ordering Example/Bestellbeispiel

1 ad./pcs./stück ATUM 30XD2 WCM. 06T308

Takma Uçlu Matkap Kullanım Kılavuzu : S 367 / User's Guide For U-Drills : P 367 / S.368 / Bedienungsanleitung für Vollbohrer



Delme Derinliği  
Drilling Depth  
Bohrtiefe

= 3xÇap  
= 3xDiameter  
= 3xDurchmesser

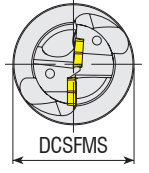
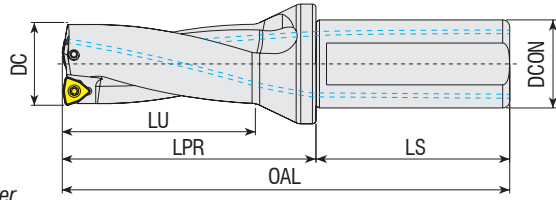

**Takım Kodu**  
**Ordering Code**  
**Bestell-Bezeichnung**

Stok Stock Lager	Takım Ölçüleri (mm) Dimension (mm) Abmessung (mm)							Maks. Ofset (radyal) Max. Offset (radial) Max. Versatz (radial)		Kesici Uç Insert Wendeschneidplatte	Sıkma Vidası Screw Schraube	Tork Anahtar Torx Key Torx-Schlüssel	
	DC	DCON	DCSFMS	OAL	LU	LPR	LS	X <sub>max</sub> X <sub>max</sub> [mm]	DC <sub>max</sub> DC <sub>max</sub> [mm]				
ATUM 16XD3 WCM. 030208	●	16	25	34	126	48	70	56	1.5	19	WCM. 030208	3008-M2.5x6	80-T08
ATUM 16.5XD3 WCM. 030208	●	16.5	25	34	126	48	70	56	1.5	19.5			
ATUM 17XD3 WCM. 030208	●	17	25	34	129	51	73	56	1.5	20			
ATUM 17.5XD3 WCM. 030208	●	17.5	25	34	129	51	73	56	1.5	20.5			
ATUM 18XD3 WCM. 030208	●	18	25	34	132	54	76	56	1.4	20.8			
ATUM 18.5XD3 WCM. 030208	●	18.5	25	34	132	54	76	56	1.3	21.1			
ATUM 19XD3 WCM. 030208	●	19	25	34	135	57	79	56	1.2	21.4	WCM. 040208	3008-M2.5x6	80-T08
ATUM 19.5XD3 WCM. 030208	●	19.5	25	34	135	57	79	56	1.2	21.9			
ATUM 20XD3 WCM. 040208	●	20	25	34	138	60	82	56	1.4	22.8			
ATUM 20.5XD3 WCM. 040208	●	20.5	25	34	138	60	82	56	1.4	23.3			
ATUM 21XD3 WCM. 040208	●	21	25	34	141	63	85	56	1	23			
ATUM 21.5XD3 WCM. 040208	●	21.5	25	34	141	63	85	56	1	23.5			
ATUM 22XD3 WCM. 040208	●	22	25	34	144	66	88	56	0.9	23.8	WCM. 050308	3008-M3x8	80-T10
ATUM 22.5XD3 WCM. 040208	●	22.5	25	34	144	66	88	56	0.9	24.3			
ATUM 23XD3 WCM. 040208	●	23	25	34	147	69	91	56	0.8	24.6			
ATUM 23.5XD3 WCM. 040208	●	23.5	25	34	147	69	91	56	0.8	25.1			
ATUM 24XD3 WCM. 050308	●	24	25	34	150	72	94	56	1.4	26.8			
ATUM 24.5XD3 WCM. 050308	●	24.5	25	34	150	72	94	56	1.4	27.3			
ATUM 25XD3 WCM. 050308	●	25	25	34	153	75	97	56	1.4	27.8	WCM. 06T308	3010-M3.5x9	80-T10
ATUM 25.5XD3 WCM. 050308	●	25.5	25	34	153	75	97	56	1.4	28.3			
ATUM 26XD3 WCM. 050308	●	26	25	34	156	78	100	56	1.4	28.8			
ATUM 26.5XD3 WCM. 050308	●	26.5	25	34	156	78	100	56	1.4	29.3			
ATUM 27XD3 WCM. 050308	●	27	25	34	159	81	103	56	1.4	29.8			
ATUM 27.5XD3 WCM. 050308	●	27.5	25	34	159	81	103	56	1.4	30.3			
ATUM 28XD3 WCM. 050308	●	28	25	34	162	84	106	56	1.4	30.8	WCM. 06T308	3010-M3.5x9	80-T10
ATUM 28.5XD3 WCM. 050308	●	28.5	25	34	162	84	106	56	1.4	31.3			
ATUM 29XD3 WCM. 050308	●	29	25	34	165	87	109	56	1.4	31.8			
ATUM 29.5XD3 WCM. 050308	●	29.5	25	34	165	87	109	56	1.4	32.3			
ATUM 30XD3 WCM. 06T308	●	30	32	44	177	90	117	60	2.4	34.8			
ATUM 30.5XD3 WCM. 06T308	●	30.5	32	44	177	90	117	60	2.4	35.3			
ATUM 31XD3 WCM. 06T308	●	31	32	44	180	93	120	60	2.3	35.6	WCM. 06T308	3010-M3.5x9	80-T10
ATUM 31.5XD3 WCM. 06T308	●	31.5	32	44	180	93	120	60	2.3	36.1			
ATUM 32XD3 WCM. 06T308	●	32	32	44	183	96	123	60	2.1	36.2			
ATUM 32.5XD3 WCM. 06T308	●	32.5	32	44	183	96	123	60	2.1	36.7			
ATUM 33XD3 WCM. 06T308	●	33	32	44	186	99	126	60	1.9	36.8			
ATUM 33.5XD3 WCM. 06T308	●	33.5	32	44	186	99	126	60	1.9	37.3			
ATUM 34XD3 WCM. 06T308	●	34	32	44	189	102	129	60	1.9	37.8	WCM. 06T308	3010-M3.5x9	80-T10
ATUM 34.5XD3 WCM. 06T308	●	34.5	32	44	189	102	129	60	1.9	38.3			

R: Sağ / Right / Rechts L: Sol/Left/Links

● Stokta / In Stock / Auf Lager ○ Stokta Yok / Non Stock Item / Kein Lagerartikel, Lieferzeit auf Anfrage

ISO Uçuna Uygundur. / Compatible with ISO Insert. / Kompatibel mit ISO Wendepalten.

Sipariş Örneği/Ordering Example/Bestellbeispiel

1 ad./pcs./stück ATUM 16XD3 WCM. 030208

Takma Uçlu Matkap Kullanım Kılavuzu : S 367 / User's Guide For U-Drills : P 367

S.368 / Bedienungsanleitung für Vollbohrer





Delme Derinliği  
Drilling Depth  
Bohrtiefe

= 3xÇap  
= 3xDiameter  
= 3xDurchmesser

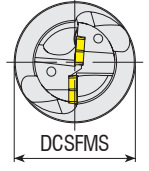
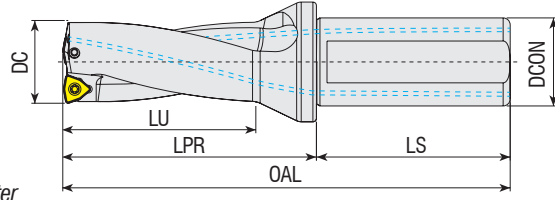

**Takım Kodu**  
**Ordering Code**  
**Bestell-Bezeichnung**

Stok  
Stock  
Lager

Takım Ölçüleri (mm)  
Dimension (mm)  
Abmessung (mm)

Maks. Ofset (radyal)  
Max. Offset (radial)  
Max. Versatz (radial)

Kesici Uç  
Insert  
Wendeschneidplatte

Yedek Parçaları / Spare Parts / Ersatzteile

Sıkma Vidası  
Screw  
Schraube

Tork Anahtar  
Torx Key  
Torx-Schlüssel

DC DCON DCSFMS OAL LU LPR LS

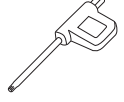
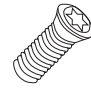
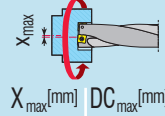

ATUM 35XD3 WCM. 06T308	●	35	32	44	192	105	132	60	1.8	38.6	WCM. 06T308	3010-M3.5x9	80-T10
ATUM 35.5XD3 WCM. 06T308	●	35.5	32	44	192	105	132	60	1.8	39.1			
ATUM 36XD3 WCM. 06T308	●	36	32	44	195	108	135	60	1.7	39.4			
ATUM 36.5XD3 WCM. 06T308	●	36.5	32	44	195	108	135	60	2	40.5			
ATUM 37XD3 WCM. 06T308	●	37	32	44	198	111	138	60	1.6	40.2			
ATUM 37.5XD3 WCM. 06T308	●	37.5	32	44	198	111	138	60	1.8	41.1			
ATUM 38XD3 WCM. 06T308	●	38	32	44	201	114	141	60	1.5	41			
ATUM 38.5XD3 WCM. 06T308	●	38.5	32	44	201	114	141	60	1.5	41.5			
ATUM 39XD3 WCM. 06T308	●	39	32	44	204	117	144	60	1.3	41.6			
ATUM 39.5XD3 WCM. 06T308	●	39.5	32	44	204	117	144	60	1.3	42.1			
ATUM 40XD3 WCM. 06T308	●	40	32	44	207	120	147	60	1	42			
ATUM 40.5XD3 WCM. 06T308	●	40.5	32	44	207	120	147	60	1	42.5			
ATUM 41XD3 WCM. 06T308	●	41	32	44	210	123	150	60	0.8	42.6			
ATUM 41.5XD3 WCM. 06T308	●	41.5	32	44	210	123	150	60	0.8	43.1			
ATUM 42XD3 WCM. 06T308	●	42	32	44	213	126	153	60	0.5	43			
ATUM 42.5XD3 WCM. 06T308	●	42.5	32	44	213	126	153	60	0.5	43.5			
ATUM 43XD3 WCM. 06T308	●	43	32	44	216	129	156	60	0.3	43.6			
ATUM 43.5XD3 WCM. 06T308	●	43.5	32	44	216	129	156	60	0.3	44.1			
ATUM 44XD3 WCM. 06T308	●	44	32	44	219	132	159	60	0	44			
ATUM 44.5XD3 WCM. 06T308	●	44.5	32	44	219	132	159	60	0	44.5			
ATUM 45XD3 WCM. 080412	●	45	40	54	237	135	167	70	3.3	51.6	WCM. 080412	4015-M4x11	80-T15
ATUM 45.5XD3 WCM. 080412	●	45.5	40	54	237	135	167	70	3.3	52.1			
ATUM 46XD3 WCM. 080412	●	46	40	54	240	138	170	70	3	52			
ATUM 47XD3 WCM. 080412	●	47	40	54	243	141	173	70	2.8	52.6			
ATUM 48XD3 WCM. 080412	●	48	40	54	246	144	176	70	2.5	53			
ATUM 49XD3 WCM. 080412	●	49	40	54	249	147	179	70	2.2	53.4			
ATUM 50XD3 WCM. 080412	●	50	40	54	252	150	182	70	2	54			
ATUM 51XD3 WCM. 080412	●	51	40	54	255	153	185	70	1.8	54.6			
ATUM 52XD3 WCM. 080412	●	52	40	54	258	156	188	70	1.5	55			
ATUM 53XD3 WCM. 080412	●	53	40	54	261	159	191	70	1.3	55.6			
ATUM 54XD3 WCM. 080412	●	54	40	54	264	162	194	70	1	56			
ATUM 55XD3 WCM. 080412	●	55	40	54	267	165	197	70	0.8	56.6			
ATUM 56XD3 WCM. 080412	●	56	40	64	270	168	200	70	0.5	57			
ATUM 57XD3 WCM. 080412	●	57	40	64	273	171	203	70	0.3	57.6			
ATUM 58XD3 WCM. 080412	●	58	40	64	276	174	206	70	0	58			
ATUM 59XD3 WCM. 080412	●	59	40	64	279	177	209	70	0	59			
ATUM 60XD3 WCM. 080412	●	60	40	64	282	180	212	70	0	60			

R: Sağ / Right / Rechts L: Sol/Left/Links

● Stokta / In Stock / Auf Lager ○ Stokta Yok / Non Stock Item / Kein Lagerartikel, Lieferzeit auf Anfrage

ISO Ucuna Uygunudur. / Compatiple with ISO Insert. / Kompatibel mit ISO Wendepplatten.

Sipariş Örneği/Ordering Example/Bestellbeispiel

1 ad./pcs./stück ATUM 35XD3 WCM. 06T308

Takma Uçlu Matkap Kullanım Kılavuzu : S 367 / User's Guide For U-Drills : P 367

S.368 / Bedienungsanleitung für Vollbohrer



Delme Derinliği  
Drilling Depth  
Bohrtiefe  
= 4xÇap  
= 4xDiameter  
= 4xDurchmesser

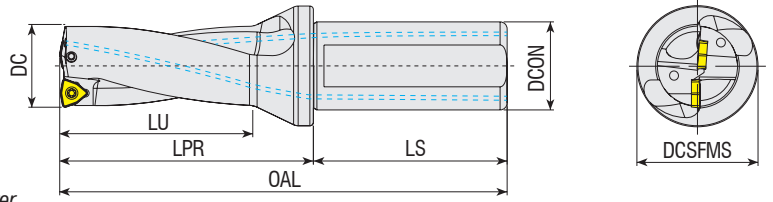

Takım Kodu Ordering Code Bestell-Bezeichnung	Stok Stock Lager	Takım Ölçüleri (mm) Dimension (mm) Abmessung (mm)							Maks. Ofset (radyal) Max. Offset (radial) Max. Versatz (radial)		Kesici Uç Insert Wendeschneidplatte	Yedek Parçaları / Spare Parts / Ersatzteile	
		DC	DCON	DCSFMS	OAL	LU	LPR	LS	$X_{max}$	$DC_{max}$		Sıkma Vidası Screw Schraube	Tork Anahtar Torx Key Torx-Schlüssel
ATUM 16XD4 WCM. 030208	●	16	25	34	142	64	86	56	1.5	19	WCM. 030208		
ATUM 16.5XD4 WCM. 030208	○	16.5	25	34	142	64	86	56	1.5	19.5			
ATUM 17XD4 WCM. 030208	●	17	25	34	146	68	90	56	1.5	20			
ATUM 17.5XD4 WCM. 030208	●	17.5	25	34	146	68	90	56	1.5	20.5			
ATUM 18XD4 WCM. 030208	●	18	25	34	150	72	94	56	1.4	20.8			
ATUM 18.5XD4 WCM. 030208	○	18.5	25	34	150	72	94	56	1.3	21.1			
ATUM 19XD4 WCM. 030208	●	19	25	34	154	76	98	56	1.2	21.4			
ATUM 19.5XD4 WCM. 030208	○	19.5	25	34	154	76	98	56	1.2	21.9			
ATUM 20XD4 WCM. 040208	●	20	25	34	158	80	102	56	1.4	22.8	WCM. 040208	3008-M2.5x6	80-T08
ATUM 20.5XD4 WCM. 040208	○	20.5	25	34	158	80	102	56	1.4	23.3			
ATUM 21XD4 WCM. 040208	●	21	25	34	162	84	106	56	1	23			
ATUM 21.5XD4 WCM. 040208	○	21.5	25	34	162	84	106	56	1	23.5			
ATUM 22XD4 WCM. 040208	●	22	25	34	166	88	110	56	0.9	23.8			
ATUM 22.5XD4 WCM. 040208	●	22.5	25	34	166	88	110	56	0.9	24.3			
ATUM 23XD4 WCM. 040208	●	23	25	34	170	92	114	56	0.8	24.6			
ATUM 23.5XD4 WCM. 040208	○	23.5	25	34	170	92	114	56	0.8	25.1			
ATUM 24XD4 WCM. 050308	●	24	25	34	174	96	118	56	1.4	26.8	WCM. 050308	3008-M3x8	
ATUM 24.5XD4 WCM. 050308	○	24.5	25	34	174	96	118	56	1.4	27.3			
ATUM 25XD4 WCM. 050308	●	25	25	34	178	100	122	56	1.4	27.8			
ATUM 25.5XD4 WCM. 050308	○	25.5	25	34	178	100	122	56	1.4	28.3			
ATUM 26XD4 WCM. 050308	●	26	25	34	182	104	126	56	1.4	28.8			
ATUM 26.5XD4 WCM. 050308	●	26.5	25	34	182	104	126	56	1.4	29.3			
ATUM 27XD4 WCM. 050308	●	27	25	34	186	108	130	56	1.4	29.8			
ATUM 27.5XD4 WCM. 050308	○	27.5	25	34	186	108	130	56	1.4	30.3			
ATUM 28XD4 WCM. 050308	●	28	25	34	190	112	134	56	1.4	30.8			
ATUM 28.5XD4 WCM. 050308	●	28.5	25	34	190	112	134	56	1.4	31.3			
ATUM 29XD4 WCM. 050308	●	29	25	34	194	116	138	56	1.4	31.8			
ATUM 29.5XD4 WCM. 050308	○	29.5	25	34	194	116	138	56	1.4	32.3			

R: Sağ / Right / Rechts L: Sol/Left/Links  
● Stokta / In Stock / Auf Lager ○ Stokta Yok / Non Stock Item / Kein Lagerartikel, Lieferzeit auf Anfrage  
ISO Ucuna Uygunudur. / Compatible with ISO Insert. / Kompatibel mit ISO Wendeplatten.

Sipariş Örneği/Ordering Example/Bestellbeispiel  
1 ad./pcs./stück ATUM 16XD4 WCM. 030208

Takma Uçlu Matkap Kullanım Kılavuzu : S 367 / User's Guide For U-Drills : P 367  
S.368 / Bedienungsanleitung für Vollbohrer



Delme Derinliği  
Drilling Depth  
Bohrtiefe  
= 4xÇap  
= 4xDiameter  
= 4xDurchmesser

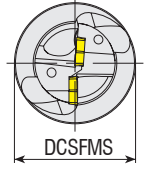
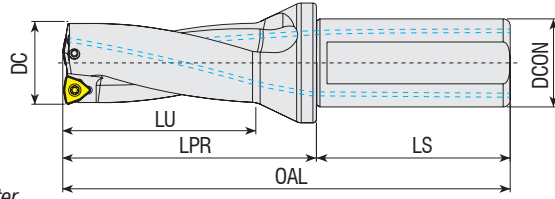

**Takım Kodu**  
**Ordering Code**  
**Bestell-Bezeichnung**

Stok  
Stock  
Lager

Takım Ölçüleri (mm)  
Dimension (mm)  
Abmessung (mm)

Maks. Ofset (radyal)  
Max. Offset (radial)  
Max. Versatz (radial)

Kesici Uç  
Insert  
Wendeschneidplatte

Yedek Parçaları / Spare Parts / Ersatzteile

Sıkma Vidası  
Screw  
Schraube

Tork Anahtar  
Torx Key  
Torx-Schlüssel

DC	DCON	DCSFMS	OAL	LU	LPR	LS
----	------	--------	-----	----	-----	----

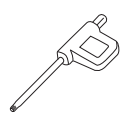
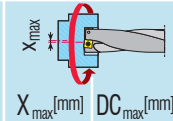

Takım Kodu	Stok	DC	DCON	DCSFMS	OAL	LU	LPR	LS	Maks. Ofset	DC_max	Kesici Uç	Sıkma Vidası	Tork Anahtar
ATUM 30XD4 WCM. 06T308	●	30	32	44	207	120	147	60	2.4	34.8	WCM. 06T308	3010-M3.5x9	80-T10
ATUM 31XD4 WCM. 06T308	●	31	32	44	211	124	151	60	2.3	35.6			
ATUM 32XD4 WCM. 06T308	●	32	32	44	215	128	155	60	2.1	36.2			
ATUM 33XD4 WCM. 06T308	●	33	32	44	219	132	159	60	1.9	36.8			
ATUM 33.5XD4 WCM. 06T308	●	33.5	32	44	219	132	159	60	1.9	37.3			
ATUM 34XD4 WCM. 06T308	●	34	32	44	223	136	163	60	1.9	37.8			
ATUM 35XD4 WCM. 06T308	●	35	32	44	227	140	167	60	1.8	38.6			
ATUM 36XD4 WCM. 06T308	●	36	32	44	231	144	171	60	1.7	39.4			
ATUM 37XD4 WCM. 06T308	●	37	32	44	235	148	175	60	1.6	40.2			
ATUM 38XD4 WCM. 06T308	●	38	32	44	239	152	179	60	1.5	41			
ATUM 38.5XD4 WCM. 06T308	●	38.5	32	44	239	152	179	60	1.5	41.5			
ATUM 39XD4 WCM. 06T308	●	39	32	44	243	156	183	60	1.3	41.6			
ATUM 40XD4 WCM. 06T308	●	40	32	44	247	160	187	60	1	42			
ATUM 41XD4 WCM. 06T308	●	41	32	44	251	164	191	60	0.8	42.6			
ATUM 42XD4 WCM. 06T308	●	42	32	44	255	168	195	60	0.5	43			
ATUM 43XD4 WCM. 06T308	●	43	32	44	259	172	199	60	0.3	43.6			
ATUM 44XD4 WCM. 06T308	●	44	32	44	263	176	203	60	0	44			
ATUM 45XD4 WCM. 080412	●	45	40	54	282	180	212	70	3.3	51.6	WCM. 080412	4015-M4x11	80-T15
ATUM 46XD4 WCM. 080412	●	46	40	54	286	184	216	70	3	52			
ATUM 47XD4 WCM. 080412	●	47	40	54	290	188	220	70	2.8	52.6			
ATUM 48XD4 WCM. 080412	●	48	40	54	294	192	224	70	2.5	53			
ATUM 49XD4 WCM. 080412	●	49	40	54	298	196	228	70	2.2	53.4			
ATUM 50XD4 WCM. 080412	●	50	40	54	302	200	232	70	2	54			

R: Sağ / Right / Rechts L: Sol/Left/Links

● Stokta / In Stock / Auf Lager ○ Stokta Yok / Non Stock Item / Kein Lagerartikel, Lieferzeit auf Anfrage  
ISO Ucuna Uygundur. / Compatible with ISO Insert. / Kompatibel mit ISO Wendeplatten.

Sipariş Örneği/Ordering Example/Bestellbeispiel  
1 ad./pcs./stück ATUM 30XD4 WCM. 06T308

Takma Uçlu Matkap Kullanım Kılavuzu : S 367 / User's Guide For U-Drills : P 367  
S.368 / Bedienungsanleitung für Vollbohrer



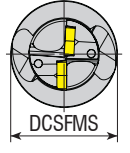
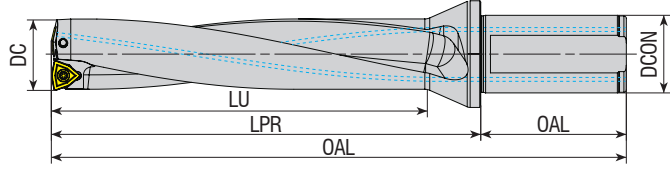

Delme Derinliği = 5xÇap  
Drilling Depth = 5xDiameter  
Bohrtiefe = 5xDurchmesser

Takım Kodu Ordering Code Bestell-Bezeichnung	Stok Stock Lager	Takım Ölçüleri (mm) Dimension (mm) Abmessung (mm)							Maks. Ofset (radyal) Max. Offset (radial) Max. Versatz (radial)	Kesici Uç Insert Wendeschneidplatte	Yedek Parçaları / Spare Parts / Ersatzteile		
		DC	DCON	DCSFMS	OAL	LU	LPR	LS			Sıkma Vidası Screw Schraube	Tork Anahtar Torx Key Torx-Schlüssel	
ATUM 20XD5 WCM. 040208	●	20	25	34	178	100	122	56	1.4	22.8	WCM. 040208	3008-M2.5x6	80-T08
ATUM 21XD5 WCM. 040208	●	21	25	34	183	105	127	56	1	23			
ATUM 22XD5 WCM. 040208	●	22	25	34	188	110	132	56	0.9	23.8			
ATUM 23XD5 WCM. 040208	●	23	25	34	193	115	137	56	0.8	24.6			
ATUM 24XD5 WCM. 050308	●	24	25	34	198	120	142	56	1.4	26.8	WCM. 050308	3008-M3x8	80-T08
ATUM 25XD5 WCM. 050308	●	25	25	34	203	125	147	56	1.4	27.8			
ATUM 26XD5 WCM. 050308	●	26	25	34	208	130	152	56	1.4	28.8			
ATUM 27XD5 WCM. 050308	●	27	25	34	213	135	157	56	1.4	29.8			
ATUM 28XD5 WCM. 050308	●	28	25	34	218	140	162	56	1.4	30.8			
ATUM 29XD5 WCM. 050308	●	29	25	34	223	145	167	56	1.4	31.8			
ATUM 30XD5 WCM. 06T308	●	30	32	44	237	150	177	60	2.4	34.8	WCM. 06T308	3010-M3.5x9	80-T10
ATUM 31XD5 WCM. 06T308	●	31	32	44	242	155	182	60	2.3	35.6			
ATUM 32XD5 WCM. 06T308	●	32	32	44	247	160	187	60	2.1	36.2			
ATUM 33XD5 WCM. 06T308	●	33	32	44	252	165	192	60	1.9	36.8			
ATUM 34XD5 WCM. 06T308	●	34	32	44	257	170	197	60	1.9	37.8			
ATUM 35XD5 WCM. 06T308	●	35	32	44	262	175	202	60	1.8	38.6			
ATUM 37XD5 WCM. 06T308	●	37	32	44	272	185	212	60	1.6	40.2			
ATUM 38XD5 WCM. 06T308	●	38	32	44	277	190	217	60	1.5	41			
ATUM 46XD5 WCM. 080412	●	46	40	54	332	230	262	70	3	52	WCM. 080412	4015-M4x11	80-T15

R: Sağ / Right / Rechts L: Sol/Left/Links

● Stokta / In Stock / Auf Lager ○ Stokta Yok / Non Stock Item / Kein Lagerartikel, Lieferzeit auf Anfrage

ISO Ucuna Uygun. / Compatible with ISO Insert. / Kompatibel mit ISO Wendepplatten.

Sipariş Örneği/Ordering Example/Bestellbeispiel

1 ad./pcs./stück ATUM 20XD5 WCM. 040208

Takma Uçlu Matkap Kullanım Kılavuzu : S 367 / User's Guide For U-Drills : P 367

S.368 / Bedienungsanleitung für Vollbohrer





Delme Derinliği  
Drilling Depth  
Bohrtiefe

= 2xÇap  
= 2xDiameter  
= 2xDurchmesser

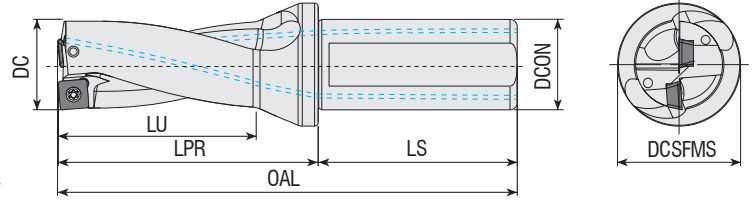

**Takım Kodu**  
**Ordering Code**  
**Bestell-Bezeichnung**

Takım Kodu Ordering Code Bestell-Bezeichnung	Stok Stock Lager	Takım Ölçüleri (mm) Dimension (mm) Abmessung (mm)							Maks. Ofset (radyal) Max. Offset (radial) Max. Versatz (radial)		Kesici Uç Insert Wendeschneidplatte	Yedek Parçaları / Spare Parts / Ersatzteile	
		DC	DCON	DCSFMS	OAL	LU	LPR	LS	$X_{max}$	$DC_{max}$		Sıkma Vidası Screw Schraube	Tork Anahtar Torx Key Torx-Schlüssel
ATUM 12.5XD2 SP.. 050204	●	12.5	20	25	96	24	46	50	0.5	13.5	SP.. 050204	3006-M2x4	80-T06
ATUM 13XD2 SP.. 050204	●	13	20	25	98	26	48	50	0.5	14			
ATUM 13.5XD2 SP.. 050204	●	13.5	20	25	98	26	48	50	0.5	14.5			
ATUM 14XD2 SP.. 050204	●	14	20	25	100	28	50	50	0.5	15			
ATUM 14.5XD2 SP.. 050204	●	14.5	20	25	100	28	50	50	0.5	15.5			
ATUM 15XD2 SP.. 050204	●	15	20	25	102	30	52	50	0.5	16			
ATUM 15.5XD2 SP.. 060204	●	15.5	20	25	102	30	52	50	0.5	16.5	SP.. 060204	3007-M2.2x5	80-T07
ATUM 16XD2 SP.. 060204	●	16	25	34	110	32	54	56	0.5	17			
ATUM 16.5XD2 SP.. 060204	●	16.5	25	34	110	32	54	56	0.5	17.5			
ATUM 17XD2 SP.. 060204	●	17	25	34	112	34	56	56	0.5	18			
ATUM 17.5XD2 SP.. 060204	●	17.5	25	34	112	34	56	56	0.5	18.5			
ATUM 18XD2 SP.. 060204	●	18	25	34	114	36	58	56	0.5	19			
ATUM 18.5XD2 SP.. 060204	●	18.5	25	34	114	36	58	56	0.5	19.5			
ATUM 19XD2 SP.. 060204	●	19	25	34	116	38	60	56	0.25	19.5			
ATUM 19.5XD2 SP.. 060204	●	19.5	25	34	116	38	60	56	0.25	20			
ATUM 20XD2 SP.. 060204	●	20	25	34	118	40	62	56	0	20			
ATUM 20.5XD2 SP.. 060204	●	20.5	25	34	118	40	62	56	0	20.5			
ATUM 21XD2 SP.. 060204	●	21	25	34	120	42	64	56	0	21			
ATUM 21.5XD2 SP.. 060204	●	21.5	25	34	120	42	64	56	0	21.5			
ATUM 22XD2 SP.. 07T308	●	22	25	34	122	44	66	56	0.5	23	SP.. 07T308	3008-M2.5x6	80-T08
ATUM 22.5XD2 SP.. 07T308	●	22.5	25	34	122	44	66	56	0.5	23.5			
ATUM 23XD2 SP.. 07T308	●	23	25	34	124	46	68	56	0.5	24			
ATUM 23.5XD2 SP.. 07T308	●	23.5	25	34	124	46	68	56	0.5	24.5			
ATUM 24XD2 SP.. 07T308	●	24	25	34	126	48	70	56	0.5	25			
ATUM 24.5XD2 SP.. 07T308	●	24.5	25	34	126	48	70	56	0.5	25.5			
ATUM 25XD2 SP.. 07T308	●	25	25	34	128	50	72	56	0.25	25.5			
ATUM 25.5XD2 SP.. 07T308	●	25.5	25	34	128	50	72	56	0.25	26			
ATUM 26XD2 SP.. 07T308	●	26	25	34	130	52	74	56	0	26			
ATUM 26.5XD2 SP.. 07T308	●	26.5	25	34	130	52	74	56	0	26.5			
ATUM 27XD2 SP.. 07T308	●	27	25	34	132	54	76	56	0	27			
ATUM 27.5XD2 SP.. 07T308	●	27.5	25	34	132	54	76	56	0	27.5			

R: Sağ / Right / Rechts L: Sol/Left/Links  
● Stokta / In Stock / Auf Lager ○ Stokta Yok / Non Stock Item / Kein Lagerartikel, Lieferzeit auf Anfrage  
TGTC Ucuna Uygunudur. / Compatiple with TGTC Insert. / Kompatibel mit TGTC Wendepplatten.

Sipariş Örneği/Ordering Example/Bestellbeispiel  
1 ad./pcs./stück ATUM 12.5XD2 SP.. 050204

Takma Uçlu Matkap Kullanım Kılavuzu : S 367 / User's Guide For U-Drills : P 367  
S.368 / Bedienungsanleitung für Vollbohrer



Delme Derinliği  
Drilling Depth  
Bohrtiefe  
= 2xÇap  
= 2xDiameter  
= 2xDurchmesser

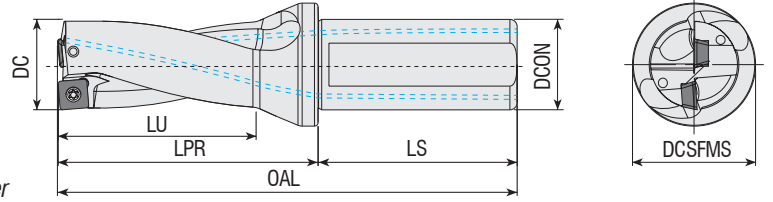

Takım Kodu Ordering Code Bestell-Bezeichnung	Stok Stock Lager	Takım Ölçüleri (mm) Dimension (mm) Abmessung (mm)							Maks. Ofset (radyal) Max. Offset (radial) Max. Versatz (radial)		Kesici Uç Insert Wendeschneidplatte	Yedek Parçaları / Spare Parts / Ersatzteile	
		DC	DCON	DCSFMS	OAL	LU	LPR	LS	X <sub>max</sub> [mm]	DC <sub>max</sub> [mm]		Sıkma Vidası Screw Schraube	Tork Anahtar Torx Key Torx-Schlüssel
ATUM 28XD2 SP. 090408	●	28	25	34	134	56	78	56	0.5	29	SP. 090408	4015-M3.5x9	80-T15
ATUM 28.5XD2 SP. 090408	●	28.5	25	34	134	56	78	56	0.5	29.5			
ATUM 29XD2 SP. 090408	●	29	25	34	136	58	80	56	0.5	30			
ATUM 29.5XD2 SP. 090408	●	29.5	25	34	136	58	80	56	0.5	30.5			
ATUM 30XD2 SP. 090408	●	30	32	44	147	60	87	60	0.5	31			
ATUM 31XD2 SP. 090408	●	31	32	44	149	62	89	60	0.25	31.5			
ATUM 32XD2 SP. 090408	●	32	32	44	151	64	91	60	0	32			
ATUM 33XD2 SP. 090408	●	33	32	44	153	66	93	60	0	33			
ATUM 34XD2 SP. 110408	●	34	32	44	155	68	95	60	0.5	35	SP. 110408	4015-M4x11	80-T15
ATUM 35XD2 SP. 110408	●	35	32	44	157	70	97	60	0.5	36			
ATUM 36XD2 SP. 110408	●	36	32	44	159	72	99	60	0.5	37			
ATUM 37XD2 SP. 110408	●	37	32	44	161	74	101	60	0.5	38			
ATUM 38XD2 SP. 110408	●	38	32	44	163	76	103	60	0.5	39			
ATUM 39XD2 SP. 110408	●	39	32	44	165	78	105	60	0.5	40			
ATUM 40XD2 SP. 110408	●	40	32	44	167	80	107	60	0.25	40.5			
ATUM 41XD2 SP. 110408	●	41	32	44	169	82	109	60	0	41			
ATUM 42XD2 SP. 140512	●	42	32	44	171	84	111	60	0.5	43	SP. 140512	1020-M5x11	80-T20
ATUM 43XD2 SP. 140512	●	43	32	44	173	86	113	60	0.5	44			
ATUM 44XD2 SP. 140512	●	44	32	44	175	88	115	60	0.5	45			
ATUM 45XD2 SP. 140512	●	45	40	54	192	90	122	70	0.5	46			
ATUM 46XD2 SP. 140512	●	46	40	54	194	92	124	70	0.5	47			
ATUM 47XD2 SP. 140512	●	47	40	54	196	94	126	70	0.5	48			
ATUM 48XD2 SP. 140512	●	48	40	54	198	96	128	70	0.25	48.5			
ATUM 49XD2 SP. 140512	●	49	40	54	200	98	130	70	0	49			
ATUM 50XD2 SP. 140512	●	50	40	54	202	100	132	70	0	50			

R: Sağ / Right / Rechts L: Sol/Left/Links

● Stokta / In Stock / Auf Lager ○ Stokta Yok / Non Stock Item / Kein Lagerartikel, Lieferzeit auf Anfrage  
TGTC Ucuna Uygunudur. / Compatible with TGTC Insert. / Kompatibel mit TGTC Wendeplatten.

Sipariş Örneği/Ordering Example/Bestellbeispiel

1 ad./pcs./stück ATUM 28XD2 SP. 090408

Takma Uçlu Matkap Kullanım Kılavuzu : S 367 / User's Guide For U-Drills : P 367  
S.368 / Bedienungsanleitung für Vollbohrer



Delme Derinliği  
Drilling Depth  
Bohrtiefe

= 3xÇap  
= 3xDiameter  
= 3xDurchmesser

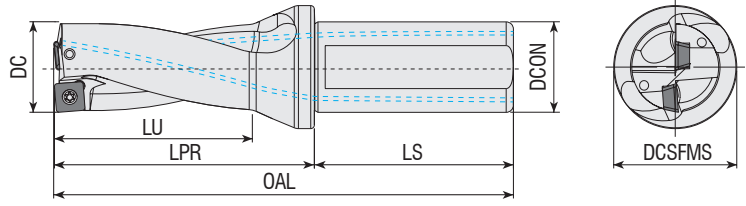

Takım Kodu  
Ordering Code  
Bestell-Bezeichnung

Stok  
Stock  
Lager

Takım Ölçüleri (mm)  
Dimension (mm)  
Abmessung (mm)

Maks. Ofset (radyal)  
Max. Offset (radial)  
Max. Versatz (radial)

Kesici Uç  
Insert  
Wendeschneidplatte

Yedek Parçaları / Spare Parts / Ersatzteile

Sıkma Vidası  
Screw  
Schraube

Tork Anahtar  
Torx Key  
Torx-Schlüssel

DC DCON DCSFMS OAL LU LPR LS

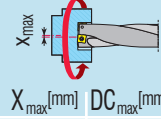

Takım Kodu Ordering Code Bestell-Bezeichnung	Stok Stock Lager	Takım Ölçüleri (mm) Dimension (mm) Abmessung (mm)							Maks. Ofset (radyal) Max. Offset (radial) Max. Versatz (radial)		Kesici Uç Insert Wendeschneidplatte	Sıkma Vidası Screw Schraube	Tork Anahtar Torx Key Torx-Schlüssel
		DC	DCON	DCSFMS	OAL	LU	LPR	LS	X <sub>max</sub> [mm]	DC <sub>max</sub> [mm]			
ATUM 12.5XD3 SP. 050204	●	12.5	20	25	108	36	58	50	0.5	13.5	SP. 050204	3006-M2x4	80-T06
ATUM 13XD3 SP. 050204	●	13	20	25	111	39	61	50	0.5	14			
ATUM 13.5XD3 SP. 050204	●	13.5	20	25	111	39	61	50	0.5	14.5			
ATUM 14XD3 SP. 050204	●	14	20	25	114	42	64	50	0.5	15			
ATUM 14.5XD3 SP. 050204	●	14.5	20	25	114	42	64	50	0.5	15.5			
ATUM 15XD3 SP. 050204	●	15	20	25	117	45	67	50	0.5	16			
ATUM 15.5XD3 SP. 060204	●	15.5	20	25	117	45	67	50	0.5	16.5			
ATUM 16XD3 SP. 060204	●	16	25	34	126	48	70	56	0.5	17			
ATUM 16.5XD3 SP. 060204	●	16.5	25	34	126	48	70	56	0.5	17.5			
ATUM 17XD3 SP. 060204	●	17	25	34	129	51	73	56	0.5	18			
ATUM 17.5XD3 SP. 060204	●	17.5	25	34	129	51	73	56	0.5	18.5			
ATUM 18XD3 SP. 060204	●	18	25	34	132	54	76	56	0.5	19			
ATUM 18.5XD3 SP. 060204	●	18.5	25	34	132	54	76	56	0.5	19.5			
ATUM 19XD3 SP. 060204	●	19	25	34	135	57	79	56	0.25	19.5			
ATUM 19.5XD3 SP. 060204	●	19.5	25	34	135	57	79	56	0.25	20			
ATUM 20XD3 SP. 060204	●	20	25	34	138	60	82	56	0	20			
ATUM 20.5XD3 SP. 060204	●	20.5	25	34	138	60	82	56	0	20.5			
ATUM 21XD3 SP. 060204	●	21	25	34	141	63	85	56	0	21			
ATUM 21.5XD3 SP. 060204	●	21.5	25	34	141	63	85	56	0	21.5			
ATUM 22XD3 SP. 07T308	●	22	25	34	144	66	88	56	0.5	23			
ATUM 22.5XD3 SP. 07T308	●	22.5	25	34	144	66	88	56	0.5	23.5			
ATUM 23XD3 SP. 07T308	●	23	25	34	147	69	91	56	0.5	24			
ATUM 23.5XD3 SP. 07T308	●	23.5	25	34	147	69	91	56	0.5	24.5			
ATUM 24XD3 SP. 07T308	●	24	25	34	150	72	94	56	0.5	25			
ATUM 24.5XD3 SP. 07T308	●	24.5	25	34	150	72	94	56	0.5	25.5			
ATUM 25XD3 SP. 07T308	●	25	25	34	153	75	97	56	0.25	25.5			
ATUM 25.5XD3 SP. 07T308	●	25.5	25	34	153	75	97	56	0.25	26			
ATUM 26XD3 SP. 07T308	●	26	25	34	156	78	100	56	0	26			
ATUM 26.5XD3 SP. 07T308	●	26.5	25	34	156	78	100	56	0	26.5			
ATUM 27XD3 SP. 07T308	●	27	25	34	159	81	103	56	0	27			
ATUM 27.5XD3 SP. 07T308	●	27.5	25	34	159	81	103	56	0	27.5			
ATUM 28XD3 SP. 090408	●	28	25	34	162	84	106	56	0.5	29			
ATUM 28.5XD3 SP. 090408	●	28.5	25	34	162	84	106	56	0.5	29.5			
ATUM 29XD3 SP. 090408	●	29	25	34	165	87	109	56	0.5	30			
ATUM 29.5XD3 SP. 090408	●	29.5	25	34	165	87	109	56	0.5	30.5			
ATUM 30XD3 SP. 090408	●	30	32	44	177	90	117	60	0.5	31			
ATUM 30.5XD3 SP. 090408	●	30.5	32	44	177	90	117	60	0.5	31.5			
ATUM 31XD3 SP. 090408	●	31	32	44	180	93	120	60	0.25	31.5			
ATUM 31.5XD3 SP. 090408	●	31.5	32	44	180	93	120	60	0.25	32			
ATUM 32XD3 SP. 090408	●	32	32	44	183	96	123	60	0	32			
ATUM 32.5XD3 SP. 090408	●	32.5	32	44	183	96	123	60	0	32.5			
ATUM 33XD3 SP. 090408	●	33	32	44	186	99	126	60	0	33			
ATUM 33.5XD3 SP. 090408	●	33.5	32	44	186	99	126	60	0	33.5			

R: Sağ / Right / Rechts L: Sol/Left/Links  
● Stokta / In Stock / Auf Lager ○ Stokta Yok / Non Stock Item / Kein Lagerartikel, Lieferzeit auf Anfrage  
TGTC Ucuna Uygunudur. / Compatible with TGTC Insert. / Kompatibel mit TGTC Wendepplatten.

Sipariş Örneği/Ordering Example/Bestellbeispiel

1 ad./pcs./stück ATUM 12.5XD3 SP. 050204

Takma Uçlu Matkap Kullanım Kılavuzu : S 367 / User's Guide For U-Drills : P 367

S.368 / Bedienungsanleitung für Vollbohrer



Delme Derinliği = 3xÇap  
Drilling Depth = 3xDiameter  
Bohrtiefe = 3xDurchmesser

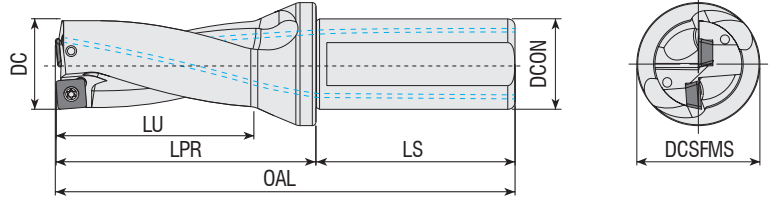

Takım Kodu Ordering Code Bestell-Bezeichnung	Stok Stock Lager	Takım Ölçüleri (mm) Dimension (mm) Abmessung (mm)								Maks. Ofset (radyal) Max. Offset (radial) Max. Versatz (radial)		Yedek Parçaları / Spare Parts / Ersatzteile		
		DC	DCON	DCSFMS	OAL	LU	LPR	LS	X <sub>max</sub> [mm] DC <sub>max</sub> [mm]		Kesici Uç Insert Wendeschneidplatte	Sıkma Vidası Screw Schraube	Tork Anahtar Torx Key Torx-Schlüssel	
									X <sub>max</sub>	DC <sub>max</sub>				
ATUM 34XD3 SP. 110408	●	34	32	44	189	102	129	60	1.4	30.8	SP. 110408	4015-M4x11	80-T15	
ATUM 34.5XD3 SP. 110408	●	34.5	32	44	189	102	129	60	1.4	31.3				
ATUM 35XD3 SP. 110408	●	35	32	44	192	105	132	60	1.4	31.8				
ATUM 35.5XD3 SP. 110408	●	35.5	32	44	192	105	132	60	1.4	32.3				
ATUM 36XD3 SP. 110408	●	36	32	44	195	108	135	60	2.4	34.8				
ATUM 36.5XD3 SP. 110408	●	36.5	32	44	195	108	135	60	2.3	35.6				
ATUM 37XD3 SP. 110408	●	37	32	44	198	111	138	60	2.1	36.2				
ATUM 37.5XD3 SP. 110408	●	37.5	32	44	198	111	138	60	1.9	36.8				
ATUM 38XD3 SP. 110408	●	38	32	44	201	114	141	60	1.9	37.8				
ATUM 38.5XD3 SP. 110408	●	38.5	32	44	201	114	141	60	1.8	38.6				
ATUM 39XD3 SP. 110408	●	39	32	44	204	117	144	60	1.7	39.4				
ATUM 39.5XD3 SP. 110408	●	39.5	32	44	204	117	144	60	1.6	40.2				
ATUM 40XD3 SP. 110408	●	40	32	44	207	120	147	60	1.5	41				
ATUM 40.5XD3 SP. 110408	●	40.5	32	44	207	120	147	60	1.3	41.6				
ATUM 41XD3 SP. 110408	●	41	32	44	210	123	150	60	1	42				
ATUM 41.5XD3 SP. 110408	●	41.5	32	44	210	123	150	60	0.8	42.6				
ATUM 42XD3 SP. 140512	●	42	32	44	213	126	153	60	0.5	43	SP. 140512	1020-M5x11	80-T20	
ATUM 42.5XD3 SP. 140512	●	42.5	32	44	213	126	153	60	0.3	43.6				
ATUM 43XD3 SP. 140512	●	43	32	44	216	129	156	60	0	44				
ATUM 43.5XD3 SP. 140512	●	43.5	32	44	216	129	156	60	3.3	51.6				
ATUM 44XD3 SP. 140512	●	44	32	44	219	132	159	60	3	52				
ATUM 44.5XD3 SP. 140512	●	44.5	32	44	219	132	159	60	2.8	52.6				
ATUM 45XD3 SP. 140512	●	45	40	54	237	135	167	70	2.5	53				
ATUM 45.5XD3 SP. 140512	●	45.5	40	54	237	135	167	70	2.2	53.4				
ATUM 46XD3 SP. 140512	●	46	40	54	240	138	170	70	2	54				
ATUM 47XD3 SP. 140512	●	47	40	54	243	141	173	70	0.2	47.4				
ATUM 48XD3 SP. 140512	●	48	40	54	246	144	176	70	0	48				
ATUM 49XD3 SP. 140512	●	49	40	54	249	147	179	70	0	49				
ATUM 50XD3 SP. 140512	●	50	40	54	252	150	182	70	0	50				
ATUM 51XD3 SP. 140512	●	51	40	54	255	153	185	70	0	51				
ATUM 52XD3 SP. 140512	●	52	40	54	258	156	188	70	0	52				

R: Sağ / Right / Rechts L: Sol/Left/Links

● Stokta / In Stock / Auf Lager ○ Stokta Yok / Non Stock Item / Kein Lagerartikel, Lieferzeit auf Anfrage  
TGTC Ucuna Uygunudur. / Compatible with TGTC Insert. / Kompatibel mit TGTC Wendepplatten.

Sipariş Örneği/Ordering Example/Bestellbeispiel

1 ad./pcs./stück ATUM 34XD3 SP. 110408

Takma Uçlu Matkap Kullanım Kılavuzu : S 367 / User's Guide For U-Drills : P 367  
S.368 / Bedienungsanleitung für Vollbohrer





Delme Derinliği  
Drilling Depth  
Bohrtiefe

= 4xÇap  
= 4xDiameter  
= 4xDurchmesser

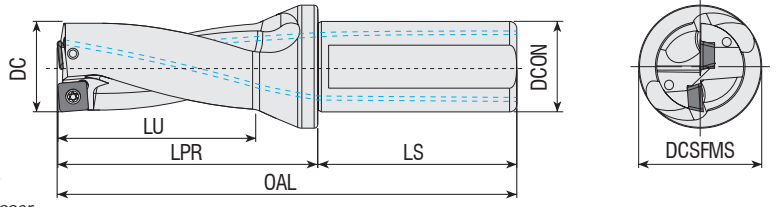

**Takım Kodu**  
**Ordering Code**  
**Bestell-Bezeichnung**

Stok  
Stock  
Lager

Takım Ölçüleri (mm)  
Dimension (mm)  
Abmessung (mm)

Maks. Ofset (radial)  
Max. Offset (radial)  
Max. Versatz (radial)

Kesici Uç  
Insert  
Wendeschneidplatte

Yedek Parçaları / Spare Parts / Ersatzteile

Sıkma Vidası  
Screw  
Schraube

Tork Anahtar  
Torx Key  
Torx-Schlüssel

ATUM	Model	SP.	Part No.	Stok	DC	DCON	DCSFMS	OAL	LU	LPR	LS	Maks. Ofset (radial)		Kesici Uç	Sıkma Vidası	Tork Anahtar
												$X_{max}$	$DC_{max}$			
ATUM	13XD4	SP.	050204	●	13	20	25	124	52	74	50	0.5	14			
ATUM	14XD4	SP.	050204	●	14	20	25	128	56	78	50	0.5	15	SP. 050204	3006-M2x4	80-T06
ATUM	15XD4	SP.	050204	●	15	20	25	132	60	82	50	0.5	16			
ATUM	16XD4	SP.	060204	●	16	25	34	142	64	86	56	0.5	17			
ATUM	17XD4	SP.	060204	●	17	25	34	146	68	90	56	0.5	18			
ATUM	17.5XD4	SP.	060204	●	17	25	34	146	68	90	56	0.5	18.5			
ATUM	18XD4	SP.	060204	●	18	25	34	150	72	94	56	0.5	19	SP. 060204	3007-M2.2x5	80-T07
ATUM	19XD4	SP.	060204	●	19	25	34	154	76	98	56	0.25	19.5			
ATUM	19.5XD4	SP.	060204	●	19.5	25	34	154	76	98	56	0.25	20			
ATUM	20XD4	SP.	060204	●	20	25	34	158	80	102	56	0	20			
ATUM	21XD4	SP.	060204	●	21	25	34	162	84	106	56	0	21			
ATUM	22XD4	SP.	07T308	●	22	25	34	166	88	110	56	0.5	23			
ATUM	23XD4	SP.	07T308	●	23	25	34	170	92	114	56	0.5	24			
ATUM	23.5XD4	SP.	07T308	●	23.5	25	34	170	92	114	56	0.5	24.5			
ATUM	24XD4	SP.	07T308	●	24	25	34	174	96	118	56	0.5	25	SP. 07T308	3008-M2.5x6	80-T08
ATUM	25XD4	SP.	07T308	●	25	25	34	178	100	122	56	0.25	25.5			
ATUM	26XD4	SP.	07T308	●	26	25	34	182	104	126	56	0	26			
ATUM	27XD4	SP.	07T308	●	27	25	34	186	108	130	56	0	27			
ATUM	27.5XD4	SP.	07T308	●	27.5	25	34	186	108	130	56	0	27.5			
ATUM	28XD4	SP.	090408	●	28	25	34	190	112	134	56	0.5	29			
ATUM	29XD4	SP.	090408	●	29	25	34	194	116	138	56	0.5	30			
ATUM	30XD4	SP.	090408	●	30	32	44	207	120	147	60	0.5	31			
ATUM	31XD4	SP.	090408	●	31	32	44	211	124	151	60	0.25	31.5	SP. 090408	4015-M3.5x9	80-T15
ATUM	32XD4	SP.	090408	●	32	32	44	215	128	155	60	0	32			
ATUM	33XD4	SP.	090408	●	33	32	44	219	132	159	60	0	33			
ATUM	33.5XD4	SP.	090408	●	33.5	32	44	219	132	159	60	0	33.5			
ATUM	34XD4	SP.	110408	●	34	32	44	223	136	163	60	0.5	35			
ATUM	35XD4	SP.	110408	●	35	32	44	227	140	167	60	0.5	36			
ATUM	36XD4	SP.	110408	●	36	32	44	231	144	171	60	0.5	37			
ATUM	37XD4	SP.	110408	●	37	32	44	235	148	175	60	0.5	38			
ATUM	38XD4	SP.	110408	●	38	32	44	239	152	179	60	0.5	39	SP. 110408	4015-M4x11	80-T15
ATUM	39XD4	SP.	110408	●	39	32	44	243	156	183	60	0.5	40			
ATUM	40XD4	SP.	110408	●	40	32	44	247	160	187	60	0.25	40.5			
ATUM	41XD4	SP.	110408	●	41	32	44	251	164	191	60	0	41			
ATUM	42XD4	SP.	140512	●	42	32	44	255	168	195	60	0.5	43			
ATUM	43XD4	SP.	140512	●	43	32	44	259	172	199	60	0.5	44	SP. 140512	1020-M5x11	80-T20
ATUM	44XD4	SP.	140512	●	44	32	44	263	176	203	60	0.5	45			

R: Sağ / Right / Rechts L: Sol/Left/Links  
● Stokta / In Stock / Auf Lager ○ Stokta Yok / Non Stock Item / Kein Lagerartikel, Lieferzeit auf Anfrage  
TGTC Ucuna Uygundur. / Compatible with TGTC Insert. / Kompatibel mit TGTC Wendepplatten.

Sipariş Örneği/Ordering Example/Bestellbeispiel

1 ad./pcs./stück ATUM 13XD4 SP. 050204

Takma Uçlu Matkap Kullanım Kılavuzu : S 367 / User's Guide For U-Drills : P 367

S.368 / Bedienungsanleitung für Vollbohrer

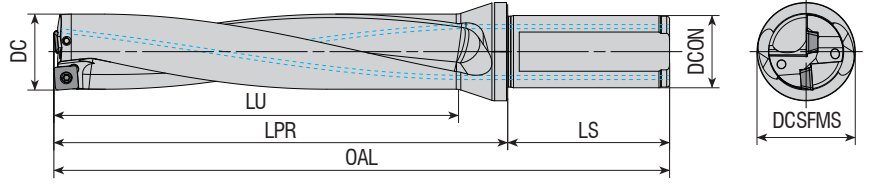

Delme Derinliği = 5xÇap  
Drilling Depth = 5xDiameter  
Bohrtiefe = 5xDurchmesser

Takım Kodu Ordering Code Bestell-Bezeichnung	Stok Stock Lager	Takım Ölçüleri (mm) Dimension (mm) Abmessung (mm)							Maks. Ofset (radyal) Max. Offset (radial) Max. Versatz (radial)		Kesici Uç Insert Wendeschneidplatte	Yedek Parçaları / Spare Parts / Ersatzteile	
		DC	DCON	DCSFMS	OAL	LU	LPR	LS	X <sub>max</sub> X <sub>max</sub> [mm]	DC <sub>max</sub> DC <sub>max</sub> [mm]		Sıkma Vidası Screw Schraube	Tork Anahtar Torx Key Torx-Schlüssel
ATUM 14XD5 SP. 050204	●	14	20	25	142	70	92	50	0.5	15.00	SP. 050204	3006-M2x4	80-T06
ATUM 16XD5 SP. 060204	●	16	25	34	158	80	102	56	0.5	17.00	SP. 060204	3007-M2.2x5	80-T07
ATUM 17XD5 SP. 060204	●	17	25	34	163	85	107	56	0.5	18.00			
ATUM 18XD5 SP. 060204	●	18	25	34	168	90	112	56	0.5	19.00			
ATUM 19XD5 SP. 060204	●	19	25	34	173	95	117	56	0.25	19.50			
ATUM 20XD5 SP. 060204	●	20	25	34	178	100	122	56	0	20.00			
ATUM 21XD5 SP. 060204	●	21	25	34	183	105	127	56	0	21.00			
ATUM 22XD5 SP. 07T308	●	22	25	34	188	110	132	56	0.5	23.00	SP. 07T308	3008-M2.5x6	80-T08
ATUM 22XD5 SP. 07T308-32	●	22	32	44	197	110	137	60	0.5	23.00			
ATUM 23XD5 SP. 07T308	●	23	25	34	193	115	137	56	0.5	24.00			
ATUM 23XD5 SP. 07T308-32	●	23	32	44	202	115	142	60	0.5	24.00			
ATUM 24XD5 SP. 07T308-32	●	24	32	44	207	120	147	60	0.5	25.00			
ATUM 25XD5 SP. 07T308	●	25	25	34	203	125	147	56	0.25	25.50			
ATUM 25XD5 SP. 07T308-32	●	25	32	44	212	125	152	60	0.25	25.50			
ATUM 26XD5 SP. 07T308	●	26	25	34	208	130	152	56	0	26.00			
ATUM 26XD5 SP. 07T308-32	●	26	32	44	217	130	157	60	0	26.00			
ATUM 27XD5 SP. 07T308	●	27	25	34	213	135	157	56	0	27.00			
ATUM 27XD5 SP. 07T308-32	●	27	32	44	222	135	162	60	0	27.00			
ATUM 28XD5 SP. 090408-32	●	28	32	44	227	140	167	60	0.5	29.00	SP. 090408	4015-M3.5x9	80-T15
ATUM 29XD5 SP. 090408-32	●	29	32	44	232	145	172	60	0.5	30.00			
ATUM 30XD5 SP. 090408	●	30	32	44	237	150	177	60	0.5	31.00			
ATUM 31XD5 SP. 090408	●	31	32	44	242	155	182	60	0.25	31.50			
ATUM 32XD5 SP. 090408	●	32	32	44	247	160	187	60	0	32.00			
ATUM 33XD5 SP. 090408	●	33	32	44	252	165	192	60	0	33.00			

R: Sağ / Right / Rechts L: Sol/Left/Links  
● Stokta / In Stock / Auf Lager ○ Stokta Yok / Non Stock Item / Kein Lagerartikel, Lieferzeit auf Anfrage  
TGTC Ucuna Uygunudur. / Compatible with TGTC Insert. / Kompatibel mit TGTC Wendeplatten.

Sipariş Örneği/Ordering Example/Bestellbeispiel  
1 ad./pcs./stück ATUM 14XD5 SP. 050204  
Takma Uçlu Matkap Kullanım Kılavuzu : S 367 / User's Guide For U-Drills : P 367  
S.368 / Bedienungsanleitung für Vollbohrer



Delme Derinliği  
Drilling Depth  
Bohrtiefe

= 2xÇap  
= 2xDiameter  
= 2xDurchmesser

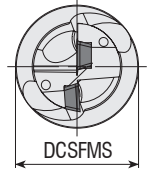
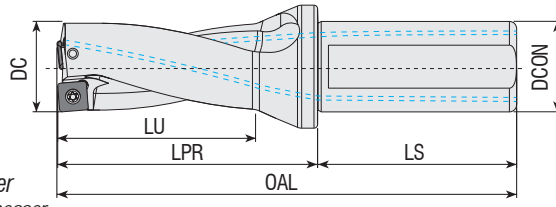

**Takım Kodu**  
**Ordering Code**  
**Bestell-Bezeichnung**

Stok Stock Lager	Takım Ölçüleri (mm) Dimension (mm) Abmessung (mm)								Maks. Ofset (radyal) Max. Offset (radial) Max. Versatz (radial)		Kesici Uç Insert Wendeschneidplatte	Yedek Parçaları / Spare Parts / Ersatzteile	
	DC	DCON	DCSFMS	OAL	LU	LPR	LS	X <sub>max</sub>	X <sub>max</sub> [mm]	DC <sub>max</sub> [mm]		Sıkma Vidası Screw Schraube	Tork Anahtar Torx Key Torx-Schlüssel
●	12.5	20	25	96	24	46	50	0.5	13.5	SPGT 050204	3006-M2x4	80-T06	
●	13	20	25	98	26	48	50	0.5	14				
●	13.5	20	25	98	26	48	50	0.5	14.5				
●	14	20	25	100	28	50	50	0.5	15				
●	15	20	25	102	30	52	50	0.5	16				
●	16	25	34	110	32	54	56	0.5	17	SPGT 060204	3007-M2.2x5	80-T07	
●	16.5	25	34	110	32	54	56	0.5	17.5				
●	17	25	34	112	34	56	56	0.5	18				
●	17.5	25	34	112	34	56	56	0.5	18.5				
●	18	25	34	114	36	58	56	0.5	19				
●	18	25	34	116	38	60	56	0.25	19.5	SPGT 07T308	3008-M2.5x6	80-T08	
●	19	25	34	118	40	62	56	0	20				
●	20	25	34	118	40	62	56	0	20				
●	22	25	34	122	44	66	56	0.5	23				
●	22.5	25	34	122	44	66	56	0.5	23.5				
●	23	25	34	124	46	68	56	0.5	24	SPGT 090408	4015-M3.5x9	80-T15	
●	24	25	34	126	48	70	56	0.5	25				
●	25	25	34	128	50	72	56	0.25	25.5				
●	26	25	34	130	52	74	56	0	26				
●	28	25	34	134	56	78	56	0.5	29				
●	29	25	34	136	58	80	56	0.5	30	SPGT 110408	4015-M4x11	80-T15	
●	30	32	44	147	60	87	60	0.5	31				
●	32	32	44	151	64	91	60	0	32				
●	35	32	44	157	70	97	60	0.5	36				
●	36	32	44	159	72	99	60	0.5	37				
●	40	32	44	167	80	107	60	0.25	40.5				

R: Sağ / Right / Rechts L: Sol/Left/Links

● Stokta / In Stock / Auf Lager ○ Stokta Yok / Non Stock Item / Kein Lagerartikel, Lieferzeit auf Anfrage  
ZCC Uçuna Uygundur. / Compatible with ZCC Insert. / Kompatibel mit ZCC Wendeplatten.

Sipariş Örneği/Ordering Example/Bestellbeispiel

1 ad./pcs./stück ATUM 12.5XD2 SPGT 050204

Takma Uçlu Matkap Kullanım Kılavuzu : S 367 / User's Guide For U-Drills : P 367  
S.368 / Bedienungsanleitung für Vollbohrer





Delme Derinliği  
Drilling Depth  
Bohrtiefe

= 3xÇap  
= 3xDiameter  
= 3xDurchmesser

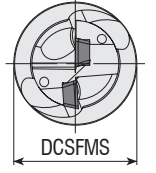
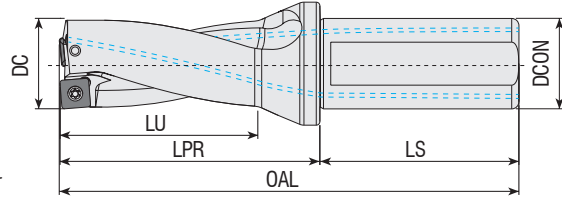

**Takım Kodu**  
**Ordering Code**  
**Bestell-Bezeichnung**

Stok  
Stock  
Lager

Takım Ölçüleri (mm)  
Dimension (mm)  
Abmessung (mm)

Maks. Ofset (radyal)  
Max. Offset (radial)  
Max. Versatz (radial)

Kesici Uç  
Insert  
Wendeschneidplatte

Yedek Parçaları / Spare Parts / Ersatzteile

Sıkma Vidası  
Screw  
Schraube

Tork Anahtar  
Torx Key  
Torx-Schlüssel

DC DCON DCSFMS OAL LU LPR LS

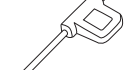
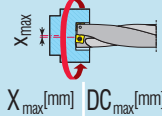

Takım Kodu Ordering Code Bestell-Bezeichnung	Stok Stock Lager	Takım Ölçüleri (mm) Dimension (mm) Abmessung (mm)							Maks. Ofset (radyal) Max. Offset (radial) Max. Versatz (radial)		Kesici Uç Insert Wendeschneidplatte	Sıkma Vidası Screw Schraube	Tork Anahtar Torx Key Torx-Schlüssel
		DC	DCON	DCSFMS	OAL	LU	LPR	LS	X <sub>max</sub>	DC <sub>max</sub> [mm]			
ATUM 12.5XD3 SPGT 050204	●	12.5	20	25	108	36	58	50	0.5	13.5	SPGT 050204	3006-M2x4	80-T06
ATUM 13XD3 SPGT 050204	●	13	20	25	111	39	61	50	0.5	14			
ATUM 13.5XD3 SPGT 050204	●	13.5	20	25	111	39	61	50	0.5	14.5			
ATUM 14XD3 SPGT 050204	●	14	20	25	114	42	64	50	0.5	15			
ATUM 14.5XD3 SPGT 050204	●	14.5	20	25	114	42	64	50	0.5	15.5			
ATUM 15XD3 SPGT 050204	●	15	20	25	117	45	67	50	0.5	16	SPGT 060204	3007-M2.2x5	80-T07
ATUM 15.5XD3 SPGT 060204	●	15.5	20	25	117	45	67	50	0.5	16.5			
ATUM 16XD3 SPGT 060204	●	16	25	34	126	48	70	56	0.5	17			
ATUM 16.5XD3 SPGT 060204	●	16.5	25	34	126	48	70	56	0.5	17.5			
ATUM 17XD3 SPGT 060204	●	17	25	34	129	51	73	56	0.5	18			
ATUM 17.5XD3 SPGT 060204	●	17.5	25	34	129	51	73	56	0.5	18.5			
ATUM 18XD3 SPGT 060204	●	18	25	34	132	54	76	56	0.5	19			
ATUM 18.5XD3 SPGT 060204	●	18.5	25	34	132	54	76	56	0.5	19.5			
ATUM 19XD3 SPGT 060204	●	19	25	34	135	57	79	56	0.25	19.5			
ATUM 19.5XD3 SPGT 060204	●	19.5	25	34	135	57	79	56	0.25	20			
ATUM 20XD3 SPGT 060204	●	20	25	34	138	60	82	56	0	20	SPGT 07T308	3008-M2.5x6	80-T08
ATUM 20.5XD3 SPGT 060204	●	20.5	25	34	138	60	82	56	0	20.5			
ATUM 21XD3 SPGT 060204	●	21	25	34	141	63	85	56	0	21			
ATUM 21.5XD3 SPGT 060204	●	21.5	25	34	141	63	85	56	0	21.5			
ATUM 22XD3 SPGT 07T308	●	22	25	34	144	66	88	56	0.5	23			
ATUM 22.5XD3 SPGT 07T308	●	22.5	25	34	144	66	88	56	0.5	23.5	SPGT 090408	4015-M3.5x9	80-T15
ATUM 23XD3 SPGT 07T308	●	23	25	34	147	69	91	56	0.5	24			
ATUM 23.5XD3 SPGT 07T308	●	23.5	25	34	147	69	91	56	0.5	24.5			
ATUM 24XD3 SPGT 07T308	●	24	25	34	150	72	94	56	0.5	25			
ATUM 24.5XD3 SPGT 07T308	●	24.5	25	34	150	72	94	56	0.5	25.5			
ATUM 25XD3 SPGT 07T308	●	25	25	34	153	75	97	56	0.25	25.5			
ATUM 25.5XD3 SPGT 07T308	●	25.5	25	34	153	75	97	56	0.25	26			
ATUM 26XD3 SPGT 07T308	●	26	25	34	156	78	100	56	0	26			
ATUM 26.5XD3 SPGT 07T308	●	26.5	25	34	156	78	100	56	0	26.5			
ATUM 27XD3 SPGT 07T308	●	27	25	34	159	81	103	56	0	27			
ATUM 27.5XD3 SPGT 07T308	●	27.5	25	34	159	81	103	56	0	27.5			
ATUM 28XD3 SPGT 090408	●	28	25	34	162	84	106	56	0.5	29	SPGT 090408	4015-M3.5x9	80-T15
ATUM 28.5XD3 SPGT 090408	●	28.5	25	34	162	84	106	56	0.5	29.5			
ATUM 29XD3 SPGT 090408	●	29	25	34	165	87	109	56	0.5	30			
ATUM 29.5XD3 SPGT 090408	●	29.5	25	34	165	87	109	56	0.5	30.5			
ATUM 30XD3 SPGT 090408	●	30	32	44	177	90	117	60	0.5	31			
ATUM 31XD3 SPGT 090408	●	31	32	44	180	93	120	60	0.25	31.5			
ATUM 32XD3 SPGT 090408	●	32	32	44	183	96	123	60	0	32			
ATUM 33XD3 SPGT 090408	●	33	32	44	186	99	126	60	0	33			

R: Sağ / Right / Rechts L: Sol/Left/Links  
● Stokta / In Stock / Auf Lager ○ Stokta Yok / Non Stock Item / Kein Lagerartikel, Lieferzeit auf Anfrage  
ZCC Ucuna Uygundur. / Compatible with ZCC Insert. / Kompatibel mit ZCC Wendeschneidplatten.

Sipariş Örneği/Ordering Example/Bestellbeispiel  
1 ad./pcs./stück ATUM 12.5XD3 SPGT 050204

Takma Uçlu Matkap Kullanım Kılavuzu : S 367 / User's Guide For U-Drills : P 367  
S.368 / Bedienungsanleitung für Vollbohrer





Delme Derinliği = 3xÇap  
Drilling Depth = 3xDiameter  
Bohrtiefe = 3xDurchmesser

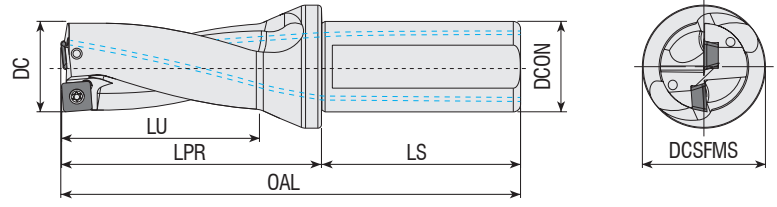

**Takım Kodu**  
**Ordering Code**  
**Bestell-Bezeichnung**

Takım Kodu Ordering Code Bestell-Bezeichnung	Stok Stock Lager	Takım Ölçüleri (mm) Dimension (mm) Abmessung (mm)							Maks. Ofset (radyal) Max. Offset (radial) Max. Versatz (radial)	Kesici Uç Insert Wendeschneidplatte	Yedek Parçaları / Spare Parts / Ersatzteile		
		DC	DCON	DCSFMS	OAL	LU	LPR	LS			Sıkma Vidası Screw Schraube	Tork Anahtar Torx Key Torx-Schlüssel	
ATUM 34XD3 SPGT 110408	●	34	32	44	189	102	129	60	0.5	35	SPGT 110408	4015-M4x11	80-T15
ATUM 35XD3 SPGT 110408	●	35	32	44	192	105	132	60	0.5	36			
ATUM 37XD3 SPGT 110408	●	37	32	44	198	111	138	60	0.5	38			
ATUM 38XD3 SPGT 110408	●	38	32	44	201	114	141	60	0.5	39			
ATUM 39XD3 SPGT 110408	●	39	32	44	204	117	144	60	0.5	40			
ATUM 40XD3 SPGT 110408	●	40	32	44	207	120	147	60	0.25	40.5			
ATUM 42XD3 SPGT 140512	●	42	32	44	213	126	153	60	0.5	43	SPGT 140512	1020-M5x11	80-T20
ATUM 43XD3 SPGT 140512	●	43	32	44	216	129	156	60	0.5	44			
ATUM 44XD3 SPGT 140512	●	44	32	44	219	132	159	60	0.5	45			
ATUM 49XD3 SPGT 140512	●	49	40	54	249	147	179	70	0	49			
ATUM 50XD3 SPGT 140512	●	50	40	54	252	150	182	70	0	50			

R: Sağ / Right / Rechts L: Sol/Left/Links

● Stokta / In Stock / Auf Lager ○ Stokta Yok / Non Stock Item / Kein Lagerartikel, Lieferzeit auf Anfrage  
ZCC Ucuna Uygun / Compatible with ZCC Insert. / Kompatibel mit ZCC Wendeschneidplatten.

Sipariş Örneği/Ordering Example/Bestellbeispiel  
1 ad./pcs./stück ATUM 34XD3 SPGT 110408

Takma Uçlu Matkap Kullanım Kılavuzu : S 367 / User's Guide For U-Drills : P 367  
S.368 / Bedienungsanleitung für Vollbohrer





Delme Derinliği  
Drilling Depth  
Bohrtiefe

= 4xÇap  
= 4xDiameter  
= 4xDurchmesser

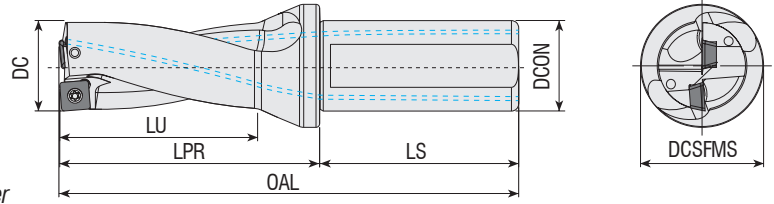

Takım Kodu  
Ordering Code  
Bestell-Bezeichnung

Stok  
Stock  
Lager

Takım Ölçüleri (mm)  
Dimension (mm)  
Abmessung (mm)

Maks. Ofset (radyal)  
Max. Offset (radial)  
Max. Versatz (radial)

Kesici Uç  
Insert  
Wendeschneidplatte

Yedek Parçaları / Spare Parts / Ersatzteile

Sıkma Vidası  
Screw  
Schraube

Tork Anahtar  
Torx Key  
Torx-Schlüssel

Takım Kodu Ordering Code Bestell-Bezeichnung	Stok Stock Lager	Takım Ölçüleri (mm) Dimension (mm) Abmessung (mm)							Maks. Ofset (radyal) Max. Offset (radial) Max. Versatz (radial)		Kesici Uç Insert Wendeschneidplatte	Sıkma Vidası Screw Schraube	Tork Anahtar Torx Key Torx-Schlüssel
		DC	DCON	DCSFMS	OAL	LU	LPR	LS	X <sub>max</sub> X <sub>max</sub> [mm]	DC <sub>max</sub> DC <sub>max</sub> [mm]			
ATUM 13XD4 SPGT 050204	●	13	20	25	124	52	74	50	0.5	14	SPGT 050204	3006-M2x4	80-T06
ATUM 14XD4 SPGT 050204	●	14	20	25	128	56	78	50	0.5	15			
ATUM 15XD4 SPGT 050204	●	15	20	25	132	60	82	50	0.5	16			
ATUM 16XD4 SPGT 060204	●	16	25	34	142	64	86	56	0.5	17	SPGT 060204	3007-M2.2x5	80-T07
ATUM 17XD4 SPGT 060204	●	17	25	34	146	68	90	56	0.5	18			
ATUM 17.5XD4 SPGT 060204	●	17.5	25	34	146	68	90	56	0.5	18.5			
ATUM 18XD4 SPGT 060204	●	18	25	34	150	72	94	56	0.5	19			
ATUM 19XD4 SPGT 060204	●	19	25	34	154	76	98	56	0.25	19.5			
ATUM 19.5XD4 SPGT 060204	●	19.5	25	34	154	76	98	56	0.25	20			
ATUM 20XD4 SPGT 060204	●	20	25	34	158	80	102	56	0	20			
ATUM 21XD4 SPGT 060204	●	21	25	34	162	84	106	56	0	21	SPGT 07T308	3008-M2.5x6	80-T08
ATUM 22XD4 SPGT 07T308	●	22	25	34	166	88	110	56	0.5	23			
ATUM 23XD4 SPGT 07T308	●	23	25	34	170	92	114	56	0.5	24			
ATUM 23.5XD4 SPGT 07T308	●	23.5	25	34	170	92	114	56	0.5	24.5			
ATUM 24XD4 SPGT 07T308	●	24	25	34	174	96	118	56	0.5	25			
ATUM 25XD4 SPGT 07T308	●	25	25	34	178	100	122	56	0.25	25.5			
ATUM 26XD4 SPGT 07T308	●	26	25	34	182	104	126	56	0	26			
ATUM 27.5XD4 SPGT 07T308	●	27.5	25	34	186	108	130	56	0	27.5	SPGT 090408	4015-M3.5x9	80-T15
ATUM 28XD4 SPGT 090408	●	28	25	34	190	112	134	56	0.5	29			
ATUM 29XD4 SPGT 090408	●	29	25	34	194	116	138	56	0.5	30			
ATUM 30XD4 SPGT 090408	●	30	32	44	207	120	147	60	0.5	31	SPGT 110408	4015-M4x11	80-T15
ATUM 33.5XD4 SPGT 090408	●	33.5	32	44	219	132	159	60	0	33.5			
ATUM 38XD4 SPGT 110408	●	38	32	44	239	152	179	60	0.5	39			

R: Sağ / Right / Rechts L: Sol/Left/Links

● Stokta / In Stock / Auf Lager ○ Stokta Yok / Non Stock Item / Kein Lagerartikel, Lieferzeit auf Anfrage  
ZCC Ucuna Uygunudur. / Compatiple with ZCC Insert. / Kompatibel mit ZCC Wendeplatten.

Sipariş Örneği/Ordering Example/Bestellbeispiel

1 ad./pcs./stück ATUM 13XD4 SPGT 050204

Takma Uçlu Matkap Kullanım Kılavuzu : S 367 / User's Guide For U-Drills : P 367  
S.368 / Bedienungsanleitung für Vollbohrer





Delme Derinliği  
Drilling Depth  
Bohrtiefe  
= 3xÇap  
= 3xDiameter  
= 3xDurchmesser

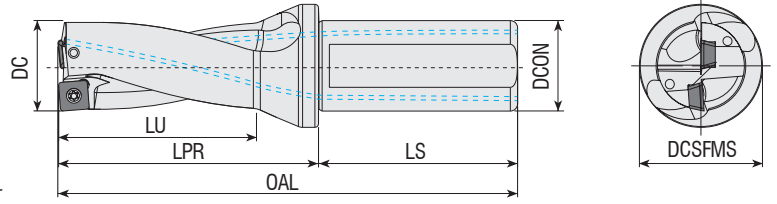

Takım Kodu  
Ordering Code  
Bestell-Bezeichnung

Stok  
Stock  
Lager

Takım Ölçüleri (mm)  
Dimension (mm)  
Abmessung (mm)

Maks. Ofset (radyal)  
Max. Offset (radial)  
Max. Versatz (radial)

Kesici Uç  
Insert  
Wendeschneidplatte

Yedek Parçaları / Spare Parts / Ersatzteile

Sıkma Vidası  
Screw  
Schraube

Tork Anahtar  
Torx Key  
Torx-Schlüssel

Takım Kodu Ordering Code Bestell-Bezeichnung	Stok Stock Lager	Takım Ölçüleri (mm) Dimension (mm) Abmessung (mm)							Maks. Ofset (radyal) Max. Offset (radial) Max. Versatz (radial)		Kesici Uç Insert Wendeschneidplatte	Sıkma Vidası Screw Schraube	Tork Anahtar Torx Key Torx-Schlüssel
		DC	DCON	DCSFMS	OAL	LU	LPR	LS	X <sub>max</sub> X <sub>max</sub> [mm]	DC <sub>max</sub> DC <sub>max</sub> [mm]			
ATUM 14XD3 SO.. 050204	●	14	20	25	114	42	64	50	1.4	16.8	SO.. 050204	3006-M2x4	80-T06
ATUM 15XD3 SO.. 050204	●	15	20	25	117	45	67	50	1.2	17.4			
ATUM 16XD3 SO.. 050204	●	16	25	34	126	48	70	56	0.9	17.8			
ATUM 16.5XD3 SO.. 050204	●	16.5	25	34	126	48	70	56	0.8	18.1			
ATUM 17XD3 SO.. 050204	●	17	25	34	129	51	73	56	0.65	18.3			
ATUM 17.5XD3 SO.. 050204	●	17.5	25	34	129	51	73	56	0.5	18.5			
ATUM 18XD3 SO.. 060304	●	18	25	34	132	54	76	56	1.15	20.3	SO.. 060304	3007-M2.2x5	80-T07
ATUM 19XD3 SO.. 060204	●	19	25	34	135	57	79	56	0.9	20.8			
ATUM 20XD3 SO.. 060304	●	20	25	34	138	60	82	56	0.65	21.3			
ATUM 21XD3 SO.. 070305	●	21	25	34	141	63	85	56	1.75	24.5	SO.. 070305	3008-M2.5x6	80-T08
ATUM 22XD3 SO.. 070305	●	22	25	34	144	66	88	56	1.5	25			
ATUM 22.5XD3 SO.. 070305	●	22.5	25	34	144	66	88	56	1.35	25.2			
ATUM 23XD3 SO.. 070305	●	23	25	34	147	69	91	56	1.25	25.5			
ATUM 24XD3 SO.. 070305	●	24	25	34	150	72	94	56	1	26			
ATUM 25XD3 SO.. 09T306	●	25	25	34	153	75	97	56	2.25	29.5			
ATUM 26XD3 SO.. 09T306	●	26	25	34	156	78	100	56	2	30	SO.. 09T306	4010-M3x8	80-T10
ATUM 27XD3 SO.. 09T306	●	27	25	34	159	81	103	56	1.75	30.5			
ATUM 29XD3 SO.. 09T306	●	29	25	34	174	87	114	56	1.25	31.5			
ATUM 30XD3 SO.. 09T306	●	30	32	44	177	90	117	60	1	32			
ATUM 31XD3 SO.. 09T306	●	31	32	44	200	93	120	60	0.75	32.5			
ATUM 33XD3 SO.. 09T306	●	33	32	44	186	99	126	60	0.5	34	SO..120408	4015-M4X11	80-T15
ATUM 35XD3 SO.. 120408	●	35	32	44	192	105	132	60	2.75	40.5			
ATUM 36XD3 SO.. 120408	●	36	32	44	195	108	135	60	2.5	41			
ATUM 37XD3 SO.. 120408	●	37	32	44	198	111	138	60	2.25	41.5			
ATUM 38XD3 SO.. 120408	●	38	32	44	201	114	141	60	1.75	41.5			
ATUM 39XD3 SO.. 120408	●	39	32	44	204	117	144	60	1.75	42.5			
ATUM 40XD3 SO.. 120408	●	40	32	44	207	120	147	60	1.5	43			
ATUM 43XD3 SO.. 120408	●	43	32	44	216	129	156	60	0.75	44.5			

R: Sağ / Right / Rechts L: Sol/Left/Links

● Stokta / In Stock / Auf Lager ○ Stokta Yok / Non Stock Item / Kein Lagerartikel, Lieferzeit auf Anfrage  
ISCR Ucuna Uygunudur. / Compatible with ISCR Insert. / Kompatibel mit ISCR Wendepfetten.

Sipariş Örneği/Ordering Example/Bestellbeispiel

1 ad./pcs./stück ATUM 14XD3 SO.. 050204

Takma Uçlu Matkap Kullanım Kılavuzu : S 367 / User's Guide For U-Drills : P 367

S.368 / Bedienungsanleitung für Vollbohrer



Delme Derinliği  
Drilling Depth  
Bohrtiefe

= 4xÇap  
= 4xDiameter  
= 4xDurchmesser

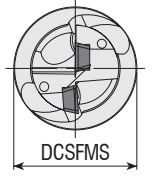
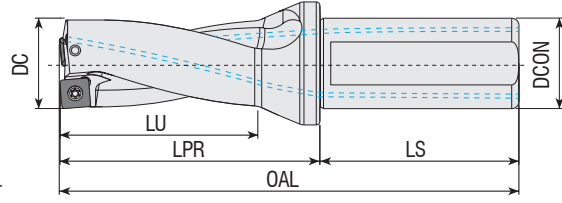

Takım Kodu Ordering Code Bestell-Bezeichnung	Stok Stock Lager	Takım Ölçüleri (mm) Dimension (mm) Abmessung (mm)							Maks. Ofset (radyal) Max. Offset (radial) Max. Versatz (radial)		Kesici Uç Insert Wendeschneidplatte	Yedek Parçaları / Spare Parts / Ersatzteile	
		DC	DCON	DCSFMS	OAL	LU	LPR	LS	X <sub>max</sub>	DC <sub>max</sub>		Sıkma Vidası Screw Schraube	Tork Anahtar Torx Key Torx-Schlüssel
ATUM 14XD4 SO.. 050204	●	14	20	25	128	56	78	50	1.4	16.8	SO.. 050204	3006-M2x4	80-T06
ATUM 14.5XD4 SO.. 050204	●	14.5	20	25	128	56	78	50	1.3	17.1			
ATUM 15XD4 SO.. 050204	●	15	20	25	132	60	62	50	1.2	17.4			
ATUM 15.5XD4 SO.. 050204	●	15.5	20	25	132	60	82	50	1	17.5			
ATUM 17XD4 SO.. 050204	●	17	25	34	146	68	90	56	0.65	18.3	SO.. 060304	3007-M2.2x5	80-T07
ATUM 19XD4 SO.. 060304	●	19	25	34	154	76	98	56	0.9	20.8			
ATUM 19.5XD4 SO.. 060304	●	19.5	25	34	154	76	98	56	0.75	21			
ATUM 20XD4 SO.. 060304	●	20	25	34	158	80	102	56	0.65	21.3			
ATUM 21XD4 SO.. 070305	●	21	25	34	162	84	106	56	1.75	24.5	SO.. 070305	3008-M2.5x6	80-T08
ATUM 22XD4 SO.. 070305	●	22	25	34	166	88	110	56	1.5	25			
ATUM 22.5XD4 SO.. 070305	●	22.5	25	34	166	88	110	56	1.35	25.2			
ATUM 23XD4 SO.. 070305	●	23	25	34	170	92	114	56	1.25	25.5			
ATUM 24XD4 SO.. 070305	●	24	25	34	174	96	118	56	1	26	SO.. 09T306	4010-M3x8	80-T10
ATUM 25XD4 SO.. 09T306	●	25	25	34	178	100	122	56	2.25	29.5			
ATUM 27XD4 SO.. 09T306	●	27	25	34	186	108	130	56	1.75	30.5			
ATUM 28XD4 SO.. 09T306	●	28	25	34	190	112	134	56	1.5	31			
ATUM 29XD4 SO.. 09T306	●	29	25	34	194	116	138	56	1.25	31.5	SO.. 120408	4015-M4X11	80-T15
ATUM 30XD4 SO.. 09T306	●	30	32	44	207	120	147	60	1	32			
ATUM 31XD4 SO.. 09T306	●	31	32	44	211	124	151	60	0.75	32.5			
ATUM 33XD4 SO.. 09T306	●	33	32	44	219	132	159	60	0.5	34			
ATUM 34XD4 SO.. 09T306	●	34	32	44	223	136	163	60	0.25	34.5			
ATUM 35XD4 SO.. 120408	●	35	32	44	227	140	167	60	2.75	40.5			

R: Sağ / Right / Rechts L: Sol/Left/Links

● Stokta / In Stock / Auf Lager ○ Stokta Yok / Non Stock Item / Kein Lagerartikel, Lieferzeit auf Anfrage  
ISCR Ucuna Uygunudur. / Compatible with ISCR Insert. / Kompatibel mit ISCR Wendeplatten.

Sipariş Örneği/Ordering Example/Bestellbeispiel

1 ad./pcs./stück ATUM 14XD4 SO.. 050204

Takma Uçlu Matkap Kullanım Kılavuzu : S 367 / User's Guide For U-Drills : P 367  
S.368 / Bedienungsanleitung für Vollbohrer





Delme Derinliği  
Drilling Depth  
Bohrtiefe

= 2xÇap  
= 2xDiameter  
= 2xDurchmesser

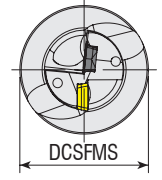
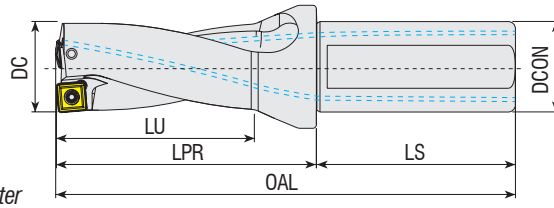

**Takım Kodu**  
**Ordering Code**  
Bestell-Bezeichnung

Stok  
Stock  
Lager

Takım Ölçüleri (mm)  
Dimension (mm)  
Abmessung (mm)

Maks. Ofset (radyal)  
Max. Offset (radial)  
Max. Versatz (radial)

Kesici Uç  
Insert  
Wendeschneidplatte

Yedek Parçaları / Spare Parts / Ersatzteile

Sıkma Vidası  
Screw  
Schraube

Tork Anahtar  
Torx Key  
Torx-Schlüssel

ATUM	KDR	0502..	●	DC	DCON	DCSFMS	OAL	LU	LPR	LS	X <sub>max</sub>	DC <sub>max</sub>	Kesici Uç Insert Wendeschneidplatte	Sıkma Vidası Screw Schraube	Tork Anahtar Torx Key Torx-Schlüssel
ATUM 14XD2	KDR 0502..	●	14	20	25	100	28	50	50	0.25	14.5	SPMT 050204-XOMT 050204	3006-M2x4	80-T06	
ATUM 18XD2	KDR 0602..	●	18	25	34	114	36	58	56	0.5	19	SPMT 060205-XOMT 060204	3007-M2.2x5	80-T07	
ATUM 20XD2	KDR 07T2..	●	20	25	34	118	40	62	56	0.3	20.6	SPMT 07T208 XOMT 07T205	3008-M2.5x6	80-T08	
ATUM 22XD2	KDR 07T2..	●	22	25	34	122	44	66	56	0.3	22.6	SPMT 090308 XOMT 090305	3008-M3x7		
ATUM 24XD2	KDR 0903..	●	24	25	34	126	48	70	56	0.3	24.6				
ATUM 25XD2	KDR 0903..	●	25	25	34	128	50	72	56	0.3	25.6				
ATUM 26XD2	KDR 0903..	●	26	25	34	130	52	74	56	0.3	26.6	SPMT 11T308 XOMT 11T306	4015-M3.5x9	80-T15	
ATUM 28XD2	KDR 0903..	●	28	25	34	134	56	78	56	0.3	28.6				
ATUM 30XD2	KDR 11T3..	●	30	25	34	147	60	87	60	0.35	30.7	SPMT 11T308 XOMT 11T306	4015-M3.5x9		
ATUM 32XD2	KDR 11T3..	●	32	32	44	151	64	91	60	0.35	32.7				
ATUM 34XD2	KDR 11T3..	●	34	32	44	155	68	95	60	0.35	34.7	SPMT 130410 - XOMT 130406	4015-M4x11		
ATUM 37XD2	KDR 1304..	●	37	32	44	161	74	101	60	0.35	37.7				

KRLY Ucuna Uygunudur. / Compatible with KRLY Insert. / Kompatibel mit KRLY Wendeplatten.



Delme Derinliği  
Drilling Depth  
Bohrtiefe

= 4xÇap  
= 4xDiameter  
= 4xDurchmesser

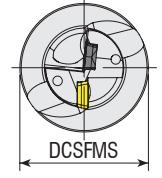
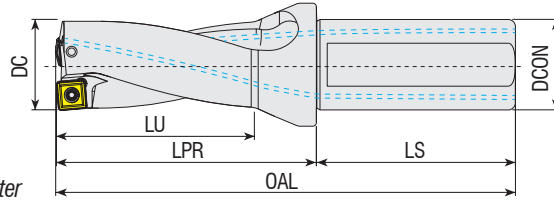

**Takım Kodu**  
**Ordering Code**  
Bestell-Bezeichnung

Stok  
Stock  
Lager

Takım Ölçüleri (mm)  
Dimension (mm)  
Abmessung (mm)

Maks. Ofset (radyal)  
Max. Offset (radial)  
Max. Versatz (radial)

Kesici Uç  
Insert  
Wendeschneidplatte

Yedek Parçaları / Spare Parts / Ersatzteile

Sıkma Vidası  
Screw  
Schraube

Tork Anahtar  
Torx Key  
Torx-Schlüssel

ATUM	KDR	0502..	●	DC	DCON	DCSFMS	OAL	LU	LPR	LS	X <sub>max</sub>	DC <sub>max</sub>	Kesici Uç Insert Wendeschneidplatte	Sıkma Vidası Screw Schraube	Tork Anahtar Torx Key Torx-Schlüssel
ATUM 14XD4	KDR 0502..	●	14	20	25	128	56	78	50	0.25	14.5	SPMT 050204 XOMT 050204	3006-M2x4	80-T06	
ATUM 14.5XD4	KDR 0502..	●	14.5	20	25	128	56	78	50	0.25	15				
ATUM 15XD4	KDR 0502..	●	15	20	25	132	60	82	50	0.25	15.5	SPMT 060205 XOMT 060204	3007-M2.2x5	80-T07	
ATUM 15.5XD4	KDR 0502..	●	15.5	20	25	132	60	82	50	0.25	16				
ATUM 16XD4	KDR 0502..	●	16	25	34	142	64	86	56	0.25	16.5	SPMT 07T208 XOMT 07T205	3008-M2.5x6	80-T08	
ATUM 17XD4	KDR 0602..	●	17	25	34	146	68	90	56	0.5	18				
ATUM 17.5XD4	KDR 0602..	●	17.5	25	34	146	68	90	56	0.5	18.5	SPMT 090308 XOMT 090305	3008-M3x7		
ATUM 18XD4	KDR 0602..	●	18	25	34	150	72	94	56	0.5	19				
ATUM 18.5XD4	KDR 0602..	●	18.5	25	34	150	72	94	56	0.5	19.5	SPMT 11T308 XOMT 11T306	4015-M3.5x9		
ATUM 19XD4	KDR 0602..	●	19	25	34	154	76	98	56	0.5	20				
ATUM 20XD4	KDR 07T2..	●	20	25	34	158	80	102	56	0.3	20.6	SPMT 130410 - XOMT 130406	4015-M4x11		
ATUM 21XD4	KDR 07T2..	●	21	25	34	162	84	106	56	0.3	21.6				
ATUM 22XD4	KDR 07T2..	●	22	25	34	166	88	110	56	0.3	22.6				
ATUM 24XD4	KDR 0903..	●	24	25	34	174	96	118	56	0.3	24.6				
ATUM 25XD4	KDR 0903..	●	25	25	34	178	100	122	56	0.3	25.6				

R: Sağ / Right / Rechts L: Sol/Left/Links

● Stokta / In Stock / Auf Lager ○ Stokta Yok / Non Stock Item / Kein Lagerartikel, Lieferzeit auf Anfrage

KRLY Ucuna Uygunudur. / Compatible with KRLY Insert. / Kompatibel mit KRLY Wendeplatten.

Sipariş Örneği/Ordering Example/Bestellbeispiel

1 ad./pcs./stück ATUM 14XD2 KDR 0502..

Takma Uçlu Matkap Kullanım Kılavuzu : S 367 / User's Guide For U-Drills : P 367 / S.368 / Bedienungsanleitung für Vollbohrer



Delme Derinliği  
Drilling Depth  
Bohrtiefe

= 3xÇap  
= 3xDiameter  
= 3xDurchmesser

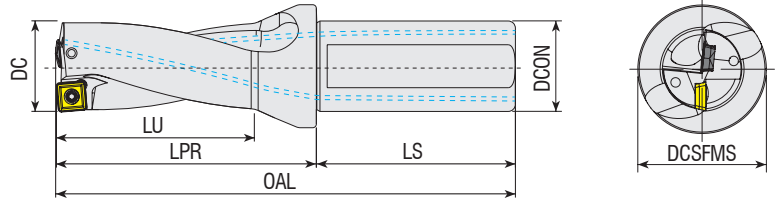

Takım Kodu  
Ordering Code  
Bestell-Bezeichnung

Takım Kodu Ordering Code Bestell-Bezeichnung	Stok Stock Lager	Takım Ölçüleri (mm) Dimension (mm) Abmessung (mm)								Maks. Ofset (radyal) Max. Offset (radial) Max. Versatz (radial)		Kesici Uç Insert Wendeschneidplatte	Yedek Parçaları / Spare Parts / Ersatzteile	
		DC	DCON	DCSFMS	OAL	LU	LPR	LS	X <sub>max</sub> [mm]	DC <sub>max</sub> [mm]	Sıkma Vidası Screw Schraube		Tork Anahtar Torx Key Torx-Schlüssel	
ATUM 12.5XD3 KDR 0402..	●	12.5	20	25	108	36	58	50	0.2	12.9	SPMT 040204 XOMT 040204	3006-M2x4	80-T06	
ATUM 13XD3 KDR 0402..	●	13	20	25	111	39	61	50	0.2	13.4				
ATUM 14XD3 KDR 0502..	●	14	20	25	114	42	64	50	0.25	14.5	SPMT 050204 XOMT 050204	3006-M2x4	80-T06	
ATUM 14.5XD3 KDR 0502..	●	14.5	20	25	114	42	64	50	0.25	15				
ATUM 15XD3 KDR 0502..	●	15	20	25	117	45	67	50	0.25	15.5	SPMT 060205 XOMT 060204	3007-M2.2x5	80-T07	
ATUM 15.5XD3 KDR 0502..	●	15.5	20	25	117	45	67	50	0.25	16				
ATUM 16XD3 KDR 0502..	●	16	25	34	126	48	70	56	0.25	16.5	SPMT 07T208 XOMT 07T205	3008-M2.5x6	80-T08	
ATUM 16.5XD3 KDR 0602..	●	16.5	25	34	126	48	70	56	0.5	17.5				
ATUM 17XD3 KDR 0602..	●	17	25	34	129	51	73	56	0.5	18	SPMT 090308 XOMT 090305	3008-M3x7	80-T15	
ATUM 17.5XD3 KDR 0602..	●	17.5	25	34	129	51	73	56	0.5	18.5				
ATUM 18XD3 KDR 0602..	●	18	25	34	132	54	76	56	0.5	19	SPMT 11T308 XOMT 11T306	4015-M3.5x9	80-T15	
ATUM 18.5XD3 KDR 0602..	●	18.5	25	34	132	54	76	56	0.5	19.5				
ATUM 19XD3 KDR 0602..	●	19	25	34	135	57	79	56	0.5	20	SPMT 130410 XOMT 130406	4015-M4x11	80-T15	
ATUM 19.5XD3 KDR 0602..	●	19.5	25	34	135	57	79	56	0.5	20.5				
ATUM 20XD3 KDR 07T2..	●	20	25	34	138	60	82	56	0.3	20.6	SPMT 11T308 XOMT 11T306	4015-M3.5x9	80-T15	
ATUM 20.5XD3 KDR 07T2..	●	20.5	25	34	138	60	82	56	0.3	21.1				
ATUM 21XD3 KDR 07T2..	●	21	25	34	141	63	85	56	0.3	21.6	SPMT 130410 XOMT 130406	4015-M4x11	80-T15	
ATUM 22XD3 KDR 07T2..	●	22	25	34	144	66	88	56	0.3	22.6				
ATUM 23XD3 KDR 07T2..	●	23	25	34	147	69	91	56	0.3	23.6	SPMT 130410 XOMT 130406	4015-M4x11	80-T15	
ATUM 23.5XD3 KDR 07T2..	●	23.5	25	34	147	69	91	56	0.3	24.1				
ATUM 24XD3 KDR 0903..	●	24	25	34	150	72	94	56	0.3	24.6	SPMT 130410 XOMT 130406	4015-M4x11	80-T15	
ATUM 24.5XD3 KDR 0903..	●	24.5	25	34	150	72	94	56	0.3	25.1				
ATUM 25XD3 KDR 0903..	●	25	25	34	153	75	97	56	0.3	25.6	SPMT 130410 XOMT 130406	4015-M4x11	80-T15	
ATUM 26XD3 KDR 0903..	●	26	25	34	156	78	100	56	0.3	26.6				
ATUM 27XD3 KDR 0903..	●	27	25	34	159	81	103	56	0.3	27.6	SPMT 130410 XOMT 130406	4015-M4x11	80-T15	
ATUM 28XD3 KDR 0903..	●	28	25	34	162	84	106	56	0.3	28.6				
ATUM 29XD3 KDR 0903..	●	29	25	34	165	87	109	56	0.3	29.6	SPMT 130410 XOMT 130406	4015-M4x11	80-T15	
ATUM 30XD3 KDR 11T3..	●	30	32	44	177	90	117	60	0.35	30.7				
ATUM 32XD3 KDR 11T3..	●	32	32	44	183	96	123	60	0.35	32.7	SPMT 130410 XOMT 130406	4015-M4x11	80-T15	
ATUM 33XD3 KDR 11T3..	●	33	32	44	186	99	126	60	0.35	33.7				
ATUM 34XD3 KDR 11T3..	●	34	32	44	189	102	129	60	0.35	34.7	SPMT 130410 XOMT 130406	4015-M4x11	80-T15	
ATUM 35XD3 KDR 11T3..	●	35	32	44	192	105	132	60	0.35	35.7				
ATUM 37XD3 KDR 1304..	●	37	32	44	198	111	138	60	0.35	37.7	SPMT 130410 XOMT 130406	4015-M4x11	80-T15	
ATUM 38XD3 KDR 1304..	●	38	32	44	201	114	141	60	0.35	38.7				
ATUM 39XD3 KDR 1304..	●	39	32	44	204	117	144	60	0.35	39.7	SPMT 130410 XOMT 130406	4015-M4x11	80-T15	
ATUM 40XD3 KDR 1304..	●	40	32	44	207	120	147	60	0.35	40.7				

R: Sağ / Right / Rechts L: Sol/Left/Links

● Stokta / In Stock / Auf Lager ○ Stokta Yok / Non Stock Item / Kein Lagerartikel, Lieferzeit auf Anfrage  
KRLY Ucuna Uygunudur. / Compatible with KRLY Insert. / Kompatibel mit KRLY Wendepplatten.

Sipariş Örneği/Ordering Example/Bestellbeispiel

1 ad./pcs./stück ATUM 12.5XD3 KDR 0402..

Takma Uçlu Matkap Kullanım Kılavuzu : S 367 / User's Guide For U-Drills : P 367  
S.368 / Bedienungsanleitung für Vollbohrer



Delme Derinliği  
Drilling Depth  
Bohrtiefe

= 2xÇap  
= 2xDiameter  
= 2xDurchmesser

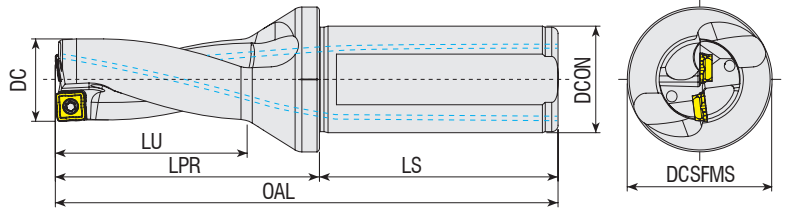

**Takım Kodu**  
**Ordering Code**  
**Bestell-Bezeichnung**

Stok  
Stock  
Lager

Takım Ölçüleri (mm)  
Dimension (mm)  
Abmessung (mm)

Maks. Ofset (radyal)  
Max. Offset (radial)  
Max. Versatz (radial)

Kesici Uç  
Insert  
Wendeschneidplatte

Yedek Parçaları / Spare Parts / Ersatzteile

Sıkma Vidası  
Screw  
Schraube

Tork Anahtar  
Torx Key  
Torx-Schlüssel

●

DC

DCON

DCSFMS

OAL

LU

LPR

LS

X<sub>max</sub>

DC<sub>max</sub>

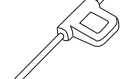
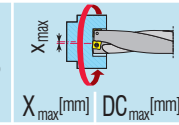

ATUM 14XD2 SOMT 050204	●	14	20	25	100	28	50	50	0.5	15	SOMT 050204	3006-M2x4	80-T06
ATUM 16XD2 SOMT 050204	●	16	25	34	110	32	54	56	0.3	16.6	SOMT 050204	3006-M2x4	80-T06
ATUM 17XD2 SOMT 060204	●	17	25	34	112	34	56	56	0.5	18	SOMT 060204	3007-M2.2x5	80-T07
ATUM 18XD2 SOMT 060204	●	18	25	34	114	36	58	56	0.4	18.8	SOMT 060204	3007-M2.2x5	80-T07
ATUM 20XD2 SOMT 070306	●	20	25	34	118	40	62	56	0.5	21	SOMT 070306	3007-M2.2x5	80-T07
ATUM 22XD2 SOMT 070306	●	22	25	34	122	44	66	56	0.3	22.6	SOMT 070306	3007-M2.2x5	80-T07
ATUM 23XD2 SOMT 08T306	●	23	25	34	124	46	68	56	0.5	24	SOMT 08T306	3008-M2.5x6	80-T08
ATUM 24XD2 SOMT 08T306	●	24	25	34	126	48	70	56	0.5	25	SOMT 08T306	3008-M2.5x6	80-T08
ATUM 25XD2 SOMT 08T306	●	25	25	34	128	50	72	56	0.4	25.8	SOMT 08T306	3008-M2.5x6	80-T08
ATUM 26XD2 SOMT 08T306	●	26	25	34	130	52	74	56	0.3	26.6	SOMT 08T306	3008-M2.5x6	80-T08
ATUM 27XD2 SOMT 09T308	●	27	25	34	132	54	76	56	0.5	28	SOMT 09T308	4015-M3.5x9	80-T15
ATUM 28XD2 SOMT 09T308	●	28	25	34	134	56	78	56	0.5	29	SOMT 09T308	4015-M3.5x9	80-T15
ATUM 29XD2 SOMT 09T308	●	29	25	34	136	58	80	56	0.5	30	SOMT 09T308	4015-M3.5x9	80-T15
ATUM 30XD2 SOMT 09T308	●	30	32	44	147	60	87	60	0.5	31	SOMT 09T308	4015-M3.5x9	80-T15
ATUM 32XD2 SOMT 11T308	●	32	32	44	151	64	91	60	0.5	33	SOMT 11T308	4015-M3.5x9	80-T15
ATUM 33XD2 SOMT 11T308	●	33	32	44	153	66	93	60	0.5	34	SOMT 11T308	4015-M3.5x9	80-T15
ATUM 34XD2 SOMT 11T308	●	34	32	44	155	68	95	60	0.5	35	SOMT 11T308	4015-M3.5x9	80-T15
ATUM 35XD2 SOMT 11T308	●	35	32	44	157	70	97	60	0.5	36	SOMT 11T308	4015-M3.5x9	80-T15
ATUM 37XD2 SOMT 130408	●	37	32	44	161	74	101	60	0.5	38	SOMT 130408	4015-M4x11	80-T20
ATUM 38XD2 SOMT 130408	●	38	32	44	163	76	103	60	0.5	39	SOMT 130408	4015-M4x11	80-T20
ATUM 40XD2 SOMT 130408	●	40	32	44	167	80	107	60	0.5	41	SOMT 130408	4015-M4x11	80-T20
ATUM 45XD2 SOMT 150510	●	45	40	54	192	90	122	70	0.5	46	SOMT 150510	1020-M5x11	80-T20
ATUM 47XD2 SOMT 150510	●	47	40	54	196	94	126	70	0.5	48	SOMT 150510	1020-M5x11	80-T20

R: Sağ / Right / Rechts L: Sol/Left/Links

● Stokta / In Stock / Auf Lager ○ Stokta Yok / Non Stock Item / Kein Lagerartikel, Lieferzeit auf Anfrage  
TGTC Ucuna Uygun. / Compatible with TGTC Insert. / Kompatibel mit TGTC Wendepplatten.

Sipariş Örneği/Ordering Example/Bestellbeispiel  
1 ad./pcs./stück ATUM 14XD2 SOMT 050204

Takma Uçlu Matkap Kullanım Kılavuzu : S 367 / User's Guide For U-Drills : P 367  
S.368 / Bedienungsanleitung für Vollbohrer



Delme Derinliği = 3xÇap  
Drilling Depth = 3xDiameter  
Bohrtiefe = 3xDurchmesser

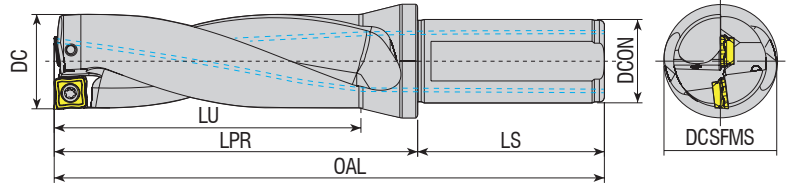

**Takım Kodu**  
**Ordering Code**  
**Bestell-Bezeichnung**

Stok  
Stock  
Lager

Takım Ölçüleri (mm)  
Dimension (mm)  
Abmessung (mm)

Maks. Ofset (radyal)  
Max. Offset (radial)  
Max. Versatz (radial)

Kesici Uç  
Insert  
Wendeschneidplatte

Yedek Parçaları / Spare Parts / Ersatzteile

Sıkma Vidası  
Screw  
Schraube

Tork Anahtar  
Torx Key  
Torx-Schlüssel

Takım Kodu Ordering Code Bestell-Bezeichnung	Stok Stock Lager	DC	DCON	DCFSMS	OAL	LU	LPR	LS	Maks. Ofset (radyal) Max. Offset (radial) Max. Versatz (radial)		Kesici Uç Insert Wendeschneidplatte	Sıkma Vidası Screw Schraube	Tork Anahtar Torx Key Torx-Schlüssel
									X <sub>max</sub> [mm]	DC <sub>max</sub> [mm]			
ATUM 14XD3 SOMT 050204	●	14	20	25	114	42	64	50	0.5	15	SOMT 050204	3006-M2x4	80-T06
ATUM 14.5XD3 SOMT 050204	●	14.5	20	25	114	42	64	50	0.4	15.3			
ATUM 15XD3 SOMT 050204	●	15	20	25	117	45	67	50	0.4	15.8			
ATUM 15.5XD3 SOMT 050204	●	15.5	20	25	117	45	67	50	0.3	16.1			
ATUM 16XD3 SOMT 050204	●	16	25	34	126	48	70	56	0.3	16.6	SOMT 060204	3007-M2.2x5	80-T07
ATUM 16.5XD3 SOMT 060204	●	16.5	25	34	126	48	70	56	0.5	17.5			
ATUM 17XD3 SOMT 060204	●	17	25	34	129	51	73	56	0.5	18			
ATUM 17.5XD3 SOMT 060204	●	17.5	25	34	129	51	73	56	0.4	18.3			
ATUM 18XD3 SOMT 060204	●	18	25	34	132	54	76	56	0.4	18.8	SOMT 070306	3008-M2.5x6	80-T08
ATUM 18.5XD3 SOMT 060204	●	18.5	25	34	132	54	76	56	0.3	19.1			
ATUM 19XD3 SOMT 060204	●	19	25	34	135	57	79	56	0.3	19.6			
ATUM 19.5XD3 SOMT 070306	●	19.5	25	34	135	57	79	56	0.5	20.5			
ATUM 20XD3 SOMT 070306	●	20	25	34	138	60	82	56	0.5	21	SOMT 08T306	4015-M3.5x9	80-T15
ATUM 20.5XD3 SOMT 070306	●	20.5	25	34	138	60	82	56	0.4	21.3			
ATUM 21XD3 SOMT 070306	●	21	25	34	141	63	85	56	0.4	21.8			
ATUM 22XD3 SOMT 070306	●	22	25	34	144	66	88	56	0.3	22.6			
ATUM 22.5XD3 SOMT 08T306	●	22.5	25	34	144	66	88	56	0.5	23.5	SOMT 09T308	4015-M4x11	80-T20
ATUM 23XD3 SOMT 08T306	●	23	25	34	147	69	91	56	0.5	24			
ATUM 23.5XD3 SOMT 08T306	●	23.5	25	34	147	69	91	56	0.5	24.5			
ATUM 24XD3 SOMT 08T306	●	24	25	34	150	72	94	56	0.5	25			
ATUM 24.5XD3 SOMT 08T306	●	24.5	25	34	150	72	94	56	0.4	25.3	SOMT 11T308	1020-M5x11	80-T20
ATUM 25XD3 SOMT 08T306	●	25	25	34	153	75	97	56	0.4	25.8			
ATUM 26XD3 SOMT 08T306	●	26	25	34	156	78	100	56	0.3	26.6			
ATUM 27XD3 SOMT 09T308	●	27	25	34	159	81	103	56	0.5	28			
ATUM 27.5XD3 SOMT 09T308	●	27.5	25	34	159	81	103	56	0.5	27.5	SOMT 130408	1020-M5x11	80-T20
ATUM 28XD3 SOMT 09T308	●	28	25	34	162	84	106	56	0.5	29			
ATUM 29XD3 SOMT 09T308	●	29	25	34	165	87	109	56	0.5	30			
ATUM 30XD3 SOMT 09T308	●	30	32	44	177	90	117	60	0.5	31			
ATUM 32XD3 SOMT 11T308	●	32	32	44	183	96	123	60	0.5	33	SOMT 150510	1020-M5x11	80-T20
ATUM 33XD3 SOMT 11T308	●	33	32	44	186	99	126	60	0.5	34			
ATUM 34XD3 SOMT 11T308	●	34	32	44	189	102	129	60	0.5	35			
ATUM 35XD3 SOMT 11T308	●	35	32	44	192	105	132	60	0.5	36			
ATUM 36XD3 SOMT 11T308	●	36	32	44	195	108	135	60	0.4	36.8	SOMT 130408	4015-M4x11	80-T15
ATUM 37XD3 SOMT 130408	●	37	32	44	198	111	138	60	0.5	38			
ATUM 38XD3 SOMT 130408	●	38	32	44	201	114	141	60	0.5	39			
ATUM 39XD3 SOMT 130408	●	39	32	44	204	117	144	60	0.5	40			
ATUM 40XD3 SOMT 130408	●	40	32	44	207	120	147	60	0.5	41	SOMT 150510	1020-M5x11	80-T20
ATUM 45XD3 SOMT 150510	●	45	40	54	237	135	167	70	0.5	46			
ATUM 49XD3 SOMT 150510	●	49	40	54	249	147	179	70	0.5	50			
ATUM 50XD3 SOMT 150510	●	50	40	54	252	150	182	70	0.5	51			

R: Sağ / Right / Rechts L: Sol/Left/Links

● Stokta / In Stock / Auf Lager ○ Stokta Yok / Non Stock Item / Kein Lagerartikel, Lieferzeit auf Anfrage

TGTC Ucuna Uygunudur. / Compatible with TGTC Insert. / Kompatibel mit TGTC Wendepplatten.

Sipariş Örneği/Ordering Example/Bestellbeispiel

1 ad./pcs./stück ATUM 14XD3 SOMT 050204

Takma Uçlu Matkap Kullanım Kılavuzu : S 367 / User's Guide For U-Drills : P 367

S.368 / Bedienungsanleitung für Vollbohrer





Delme Derinliği  
Drilling Depth  
Bohrtiefe

= 4xÇap  
= 4xDiameter  
= 4xDurchmesser

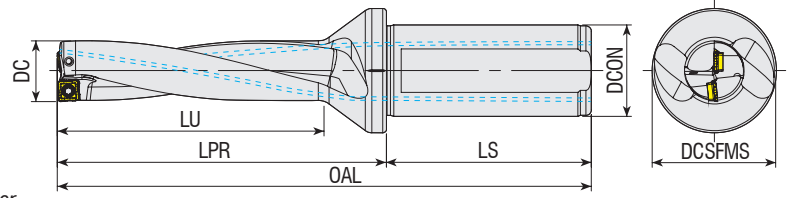

**Takım Kodu**  
**Ordering Code**  
**Bestell-Bezeichnung**

Stok  
Stock  
Lager

Takım Ölçüleri (mm)  
Dimension (mm)  
Abmessung (mm)

Maks. Ofset (radyal)  
Max. Offset (radial)  
Max. Versatz (radial)

Kesici Uç  
Insert  
Wendeschneidplatte

Yedek Parçaları / Spare Parts / Ersatzteile

Sıkma Vidası  
Screw  
Schraube

Tork Anahtar  
Torx Key  
Torx-Schlüssel

Takım Kodu Ordering Code Bestell-Bezeichnung	Stok Stock Lager	Takım Ölçüleri (mm) Dimension (mm) Abmessung (mm)							Maks. Ofset (radyal) Max. Offset (radial) Max. Versatz (radial)		Kesici Uç Insert Wendeschneidplatte	Sıkma Vidası Screw Schraube	Tork Anahtar Torx Key Torx-Schlüssel
		DC	DCON	DCSFMS	OAL	LU	LPR	LS	X <sub>max</sub> X <sub>max</sub> [mm]	DC <sub>max</sub> DC <sub>max</sub> [mm]			
ATUM 14XD4 SOMT 050204	●	14	20	25	128	56	78	50	0.5	15	SOMT 050204	3006-M2x4	80-T06
ATUM 14.5XD4 SOMT 050204	●	14.5	20	25	128	56	78	50	0.4	15.3			
ATUM 16XD4 SOMT 050204	●	16	25	34	142	64	86	56	0.3	16.6	SOMT 060204	3007-M2.2x5	80-T07
ATUM 17XD4 SOMT 060204	●	17	25	34	146	68	90	56	0.5	18			
ATUM 17.5XD4 SOMT 060204	●	17.5	25	34	146	68	90	56	0.4	18.3	SOMT 060204	3007-M2.2x5	80-T07
ATUM 18XD4 SOMT 060204	●	18	25	34	150	72	94	56	0.4	18.8			
ATUM 19XD4 SOMT 060204	●	19	25	34	154	76	98	56	0.3	19.6	SOMT 070306	3008-M2.5x6	80-T08
ATUM 20XD4 SOMT 070306	●	20	25	34	158	80	102	56	0.5	21			
ATUM 21XD4 SOMT 070306	●	21	25	34	162	84	106	56	0.4	21.8	SOMT 070306	3008-M2.5x6	80-T08
ATUM 22XD4 SOMT 070306	●	22	25	34	166	88	110	56	0.3	22.6			
ATUM 24XD4 SOMT 08T306	●	24	25	34	174	96	118	56	0.5	25	SOMT 08T306	3008-M2.5x6	80-T08
ATUM 25XD4 SOMT 08T306	●	25	25	34	178	100	122	56	0.4	25.8			

R: Sağ / Right / Rechts L: Sol/Left/Links  
● Stokta / In Stock / Auf Lager ○ Stokta Yok / Non Stock Item / Kein Lagerartikel, Lieferzeit auf Anfrage  
TGTC Ucuna Uygundur. / Compatible with TGTC Insert. / Kompatibel mit TGTC Wendeschneidplatten.

Sipariş Örneği/Ordering Example/Bestellbeispiel  
1 ad./pcs./stück ATUM ATUM 14XD4 SOMT 050204  
Takma Uçlu Matkap Kullanım Kılavuzu : S 367 / User's Guide For U-Drills : P 367  
S.368 / Bedienungsanleitung für Vollbohrer





Delme Derinliği  
Drilling Depth  
Bohrtiefe = 5xÇap  
= 5xDiameter  
= 5xDurchmesser

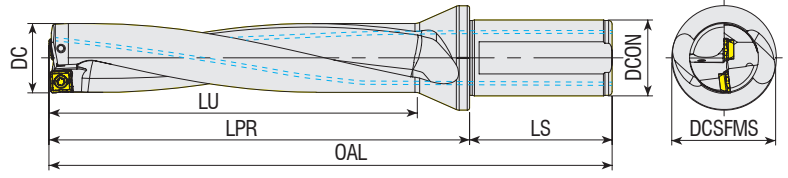

Takım Kodu Ordering Code Bestell-Bezeichnung	Stok Stock Lager	Takım Ölçüleri (mm) Dimension (mm) Abmessung (mm)							Maks. Ofset (radyal) Max. Offset (radial) Max. Versatz (radial)		Kesici Uç Insert Wendeschneidplatte	Yedek Parçaları / Spare Parts / Ersatzteile	
		DC	DCON	DCSFMS	OAL	LU	LPR	LS	X <sub>max</sub> [mm]	DC <sub>max</sub> [mm]		Sıkma Vidası Screw Schraube	Tork Anahtar Torx Key Torx-Schlüssel
ATUM 14XD5 SOMT 050204	●	14	20	25	142	70	92	50	0.5	15	SOMT 050204	3006-M2x4	80-T06
ATUM 15XD5 SOMT 050204	●	15	20	25	147	75	97	50	0.4	15.8			
ATUM 15.5XD5 SOMT 050204	●	15.5	20	25	147	75	97	50	0.3	16.1			
ATUM 16XD5 SOMT 050204	●	16	25	34	158	80	102	56	0.3	16.6	SOMT 060204	3007-M2.2x5	80-T07
ATUM 16.5XD5 SOMT 060204	●	16.5	25	34	158	80	102	56	0.5	17.5			
ATUM 17.5XD5 SOMT 060204	●	17.5	25	34	163	85	107	56	0.4	18.3			
ATUM 18XD5 SOMT 060204	●	18	25	34	168	90	112	56	0.4	18.8	SOMT 070306	3008-M2.5x6	80-T08
ATUM 18.5XD5 SOMT 060204	●	18.5	25	34	168	90	112	56	0.3	19.1			
ATUM 19XD5 SOMT 060204	●	19	25	34	173	95	117	56	0.3	19.6			
ATUM 19.5XD5 SOMT 070306	●	19.5	25	34	173	95	117	56	0.5	20.5	SOMT 08T306	4015-M3.5x9	80-T15
ATUM 20XD5 SOMT 070306	●	20	25	34	178	100	122	56	0.5	21			
ATUM 21XD5 SOMT 070306	●	21	25	34	183	105	127	56	0.4	21.8			
ATUM 22XD5 SOMT 070306	●	22	25	34	188	110	132	56	0.3	22.6	SOMT 09T308	4015-M3.5x9	80-T15
ATUM 23XD5 SOMT 08T306	●	23	25	34	193	115	137	56	0.5	24			
ATUM 24XD5 SOMT 08T306	●	24	25	34	198	120	142	56	0.5	25			
ATUM 25XD5 SOMT 08T306	●	25	25	34	203	125	147	56	0.4	25.8	SOMT 11T308	4015-M3.5x9	80-T15
ATUM 26XD5 SOMT 08T306	●	26	25	34	208	130	152	56	0.3	26.6			
ATUM 27XD5 SOMT 09T308	●	27	25	34	213	135	157	56	0.5	28			
ATUM 28XD5 SOMT 09T308	●	28	25	34	218	140	162	56	0.5	29	SOMT 11T308	4015-M3.5x9	80-T15
ATUM 29XD5 SOMT 09T308	●	29	25	34	223	145	167	56	0.5	30			
ATUM 30XD5 SOMT 09T308	●	30	32	44	237	150	177	60	0.5	31			
ATUM 33XD5 SOMT 11T308	●	33	32	44	252	165	192	60	0.5	34	SOMT 11T308	4015-M3.5x9	80-T15
ATUM 34XD5 SOMT 11T308	●	34	32	44	257	170	197	60	0.5	35			
ATUM 35XD5 SOMT 11T308	●	35	32	44	262	175	202	60	0.5	36			
ATUM 36XD5 SOMT 11T308	●	36	32	44	267	180	207	60	0.4	36.8			

R: Sağ / Right / Rechts L: Sol/Left/Links

● Stokta / In Stock / Auf Lager ○ Stokta Yok / Non Stock Item / Kein Lagerartikel, Lieferzeit auf Anfrage  
TGTC Ucuna Uygundur. / Compatible with TGTC Insert. / Kompatibel mit TGTC Wendeplatten.

Sipariş Örneği/Ordering Example/Bestellbeispiel

1 ad./pcs./stück ATUM 14XD5 SOMT 050204

Takma Uçlu Matkap Kullanım Kılavuzu : S 367 / User's Guide For U-Drills : P 367  
S.368 / Bedienungsanleitung für Vollbohrer



Delme Derinliği  
Drilling Depth  
Bohrtiefe

= 3xÇap  
= 3xDiameter  
= 3xDurchmesser

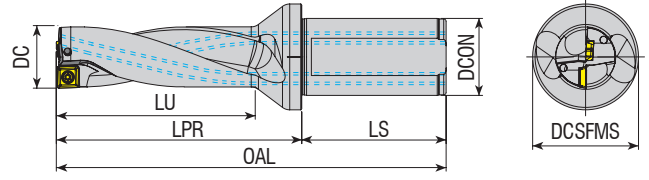

**Takım Kodu**  
**Ordering Code**  
**Bestell-Bezeichnung**

Stok  
Stock  
Lager

Takım Ölçüleri (mm)  
Dimension (mm)  
Abmessung (mm)

Maks. Ofset (radyal)  
Max. Offset (radial)  
Max. Versatz (radial)

Kesici Uç  
Insert  
Wendeschneidplatte

Yedek Parçaları / Spare Parts / Ersatzteile

Sıkma Vidası  
Screw  
Schraube

Tork Anahtar  
Torx Key  
Torx-Schlüssel

DC

DCON

DCSFMS

OAL

LU

LPR

LS

X<sub>max</sub>  
X<sub>max</sub>[mm] DC<sub>max</sub>[mm]

880-02...C/P

3006-M2x4

80-T06

880-03...C/P

3007-M2.2x5

80-T07

880-04...C/P

3008-M2.5x6

80-T08

880-05...C/P

4010-M3x8

80-T10

880-06...C/P

3010-M3.5x9

80-T10

880-07...C/P

3010-M3.5x9

80-T15

880-08...C/P

4015-M4x11

80-T15

R: Sağ / Right / Rechts L: Sol/Left/Links

● Stokta / In Stock / Auf Lager ○ Stokta Yok / Non Stock Item / Kein Lagerartikel, Lieferzeit auf Anfrage  
SNDVK Ucuna Uygunudur. / Compatible with SNDVK Insert. / Kompatibel mit SNDVK Wendeschneidplatten.

Sipariş Örneği/Ordering Example/Bestellbeispiel

1 ad./pcs./stück ATUM 14XD3 880-0202..

Takma Uçlu Matkap Kullanım Kılavuzu : S 367 / User's Guide For U-Drills : P 367

S.368 / Bedienungsanleitung für Vollbohrer

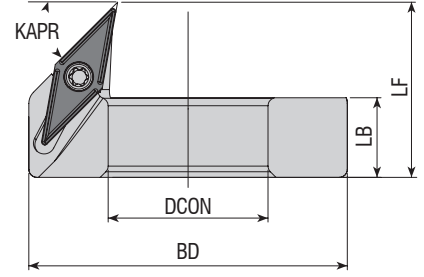

Takım Kodu Ordering Code Bestell-Bezeichnung	Stok Stock Lager	Takım Ölçüleri (mm) Dimension (mm) Abmessung (mm)				Kullanılacak ATUM Ölçüsü Compatible ATUM Diameter Verwendeter Vollbohrer	Yedek Parçaları / Spare Parts / Ersatzteile				
		BD	DCON	LB	LF		ATUM Ø	Kesici Uç Insert Wendeschneidplatte	Sıkma Vidası Screw Schraube	Tork Anahtar Torx Key Torx-Schlüssel	Montaj Vidası Mounting Screw Befestigungsschraube
ADCR-120-VB1103	●	32	12	10	22	12.5					
ADCR-125-VB1103	●	32.5	12.5	10	22	13					
ADCR-130-VB1103	●	33	13	10	22	13.5					
ADCR-135-VB1103	●	33.5	13.5	10	22	14					
ADCR-140-VB1103	●	34	14	10	22	14.5					
ADCR-145-VB1103	●	34.5	14.5	10	22	15					
ADCR-150-VB1103	●	35	15	10	22	15.5 -16					
ADCR-155-VB1103	●	35.5	15.5	10	22	16.5					
ADCR-160-VB1103	●	36	16	10	22	17					
ADCR-165-VB1103	●	36.5	16.5	10	22	17.5					
ADCR-170-VB1103	●	37	17	10	22	18					
ADCR-175-VB1103	●	37.5	17.5	10	22	18.5					
ADCR-180-VB1103	●	38	18	10	22	19					
ADCR-185-VB1103	●	38.5	18.5	10	22	19.5					
ADCR-190-VB1103	●	39	19	10	22	20					
ADCR-195-VB1103	●	39.5	19.5	10	22	20.5					
ADCR-200-VB1103	●	40	20	10	22	21					
ADCR-205-VB1103	●	40.5	20.5	10	22	21.5					
ADCR-210-VB1103	●	41	21	10	22	22	VBM. 1103..	4008-M2.5x6	80-T08	AAV-14-M5x14	AAL-03-3
ADCR-215-VB1103	●	41.5	21.5	10	22	22.5					
ADCR-220-VB1103	●	42	22	10	22	23					
ADCR-225-VB1103	●	42.5	22.5	10	22	23.5					
ADCR-230-VB1103	●	43	23	10	22	24					
ADCR-235-VB1103	●	43.5	23.5	10	22	24.5					
ADCR-240-VB1103	●	44	24	10	22	25					
ADCR-245-VB1103	●	44.5	24.5	10	22	25.5					
ADCR-250-VB1103	●	45	25	10	22	26					
ADCR-255-VB1103	●	45.5	25.5	10	22	26.5					
ADCR-260-VB1103	●	46	26	10	22	27					
ADCR-265-VB1103	●	46.5	26.5	10	22	27.5					
ADCR-270-VB1103	●	47	27	10	22	28					
ADCR-275-VB1103	●	47.5	27.5	10	22	28.5					
ADCR-280-VB1103	●	48	28	10	22	29					
ADCR-285-VB1103	●	48.5	28.5	10	22	29.5					
ADCR-290-VB1103	●	49	29	10	22	30					
ADCR-295-VB1103	●	49.5	29.5	10	22	30.5					
ADCR-300-VB1103	●	50	30	10	22	31					

R: Sağ / Right / Rechts L: Sol/Left/Links

● Stokta / In Stock / Auf Lager ○ Stokta Yok / Non Stock Item / Kein Lagerartikel, Lieferzeit auf Anfrage  
ISO Ucuna Uygundur. / Compatible with ISO Insert. / Kompatibel mit ISO Wendepatten.

Sipariş Örneği/Ordering Example/Bestellbeispiel

1 ad./pcs./stück ADCR-120-VB1103

Takma Uçlu Matkap Kullanım Kılavuzu : S 367 / User's Guide For U-Drills : P 367

S.368 / Bedienungsanleitung für Vollbohrer





Tavsiye Edilen / Recommended / Empfehlung

A

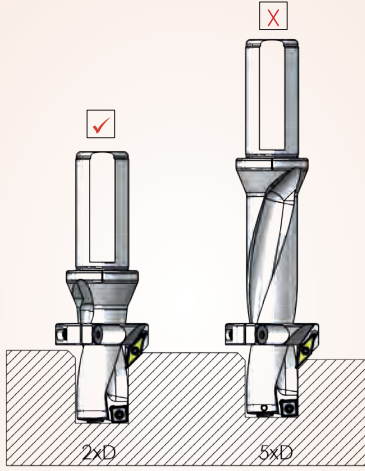

Mümkünse, her zaman kısa bir delme takımı kullanın. Değilse, titreşimi en aza indirmek için kesme hızını azaltın.  
If possible, use it always short drilling tools. Otherwise, reduce your speeds to minimize vibration.  
Bitte möglichst kurze Bohrwerkzeuge verwenden. Sollte dies nicht möglich sein, reduzieren Sie den Geschwindigkeit, um Vibrationen zu vermeiden.

B

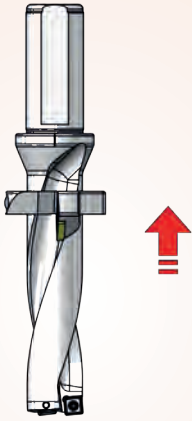

Mümkün olduğunca pah kırma halkasını shaft kısmına yakın montaj yap.  
Get close to the mounting shaft of the chamfering ring as possible.  
Befestigen Sie den Fasring möglichst nah am Schaft.

C

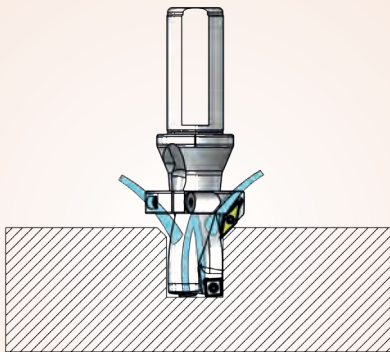

Daha iyi uç ömrü için harici soğutucu ve matkap ucu iç soğutucu uygulamak.  
Apply external cooling and internal coolant drill for a better life for inserts.  
Setzen Sie innere und äußere Kühlung ein, um die Standzeit der Wendeplatten zu erhöhen.

Montaj Şekli / Mounting System / Montage-Hinweise

1



Matkap gövdesi üzerine pah kırma halkasını takın.  
Put the chamfering ring to drill body.  
Schieben Sie den Fasring auf den Bohrkörper.

2

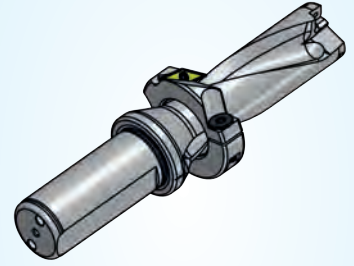

İstenilen konuma pah kırma halkasını kaydırın.  
Please slide chamfering ring to the desired position.  
Befestigen Sie den Fasring an der gewünschten Position.

3

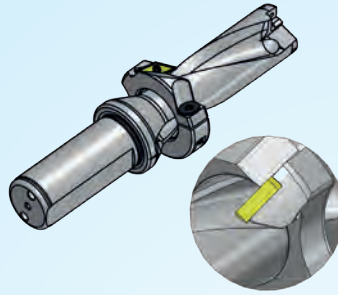

Pah kırma halkasını talaş akışına mani olmayacak şekilde helis başlangıcına denk getirin.  
Please keep chamfering ring position which will not resist to fluiding chips and try to be equal to the helix start points.  
Positionieren Sie den Fasring bündig mit der Bohrerspirale um einen problemlosen Späne transport zu gewährleisten.

4

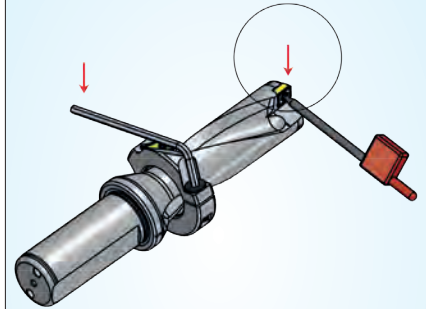

Pah kırma halkasını sıkın ve matkap uçlarını takın.  
Tightening the chamfering ring and put the drill insert.  
Den Fasring festziehen und die Bohr-Wendeplatten einbauen.

Pah kırma halkasının doğru montaj şekli.  
Proper installation of chamfering rings.  
Korrekte Montage des Fasrings.

✓

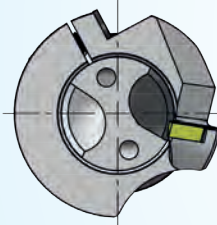

X

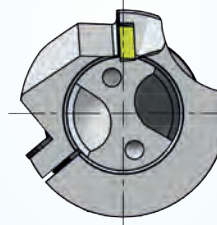

X

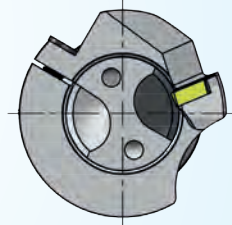

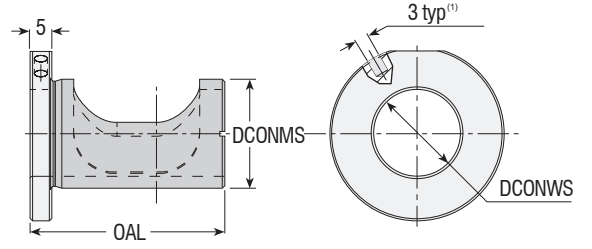

**Takım Kodu**  
**Ordering Code**  
**Bestell-Bezeichnung**

Stok  
 Stock  
 Lager

Takım Ölçüleri (mm)  
 Dimension (mm)  
 Abmessung (mm)

		DCON	BD	LF
<b>AET-2025</b>	●	20	25	44
<b>AET-2532</b>	●	25	32	46
<b>AET-3240</b>	●	32	40	55

■ (1) Delik ince bir metal yardımıyla adaptörün radyal olarak ayarlanmasını kolaylaştırmak için kullanılır. / Holes for inserting a pin, used to facilitate radial adjustment of the sleeve (pin not supplied).  
 Bohrung zum Einsetzen eines Stiftes mit dem der Adapter radial eingestellt werden kann (Stift ist nicht im Lieferumfang enthalten).

Frezeleme tezgahında takma uçlu matkabın nominal çapı, matkabın ekseninin, spindle eksenine göre ötelenmesiyle değiştirilebilir.  
 On a milling machine the drill's nominal diameter can be changed by shifting the drill's axis out of the tool spindle.

Auf einer Fräsmaschine kann die Nennweite des Bohrers durch Verschieben der Bohrerachse aus der Spindelachse verändert werden.

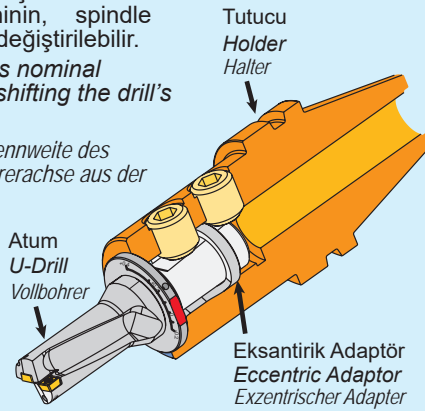

Radyal ayarlama pimi.  
 (Verilmeyecektir.)  
 Radial adjustment pin.  
 (not supplied)  
 Radial - Einstellstift  
 (nicht im Lieferumfang)

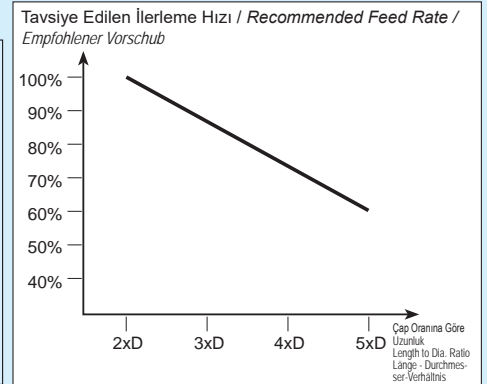
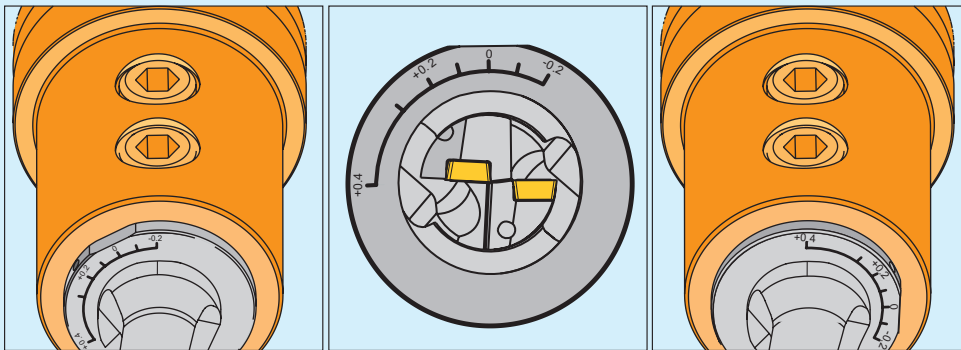
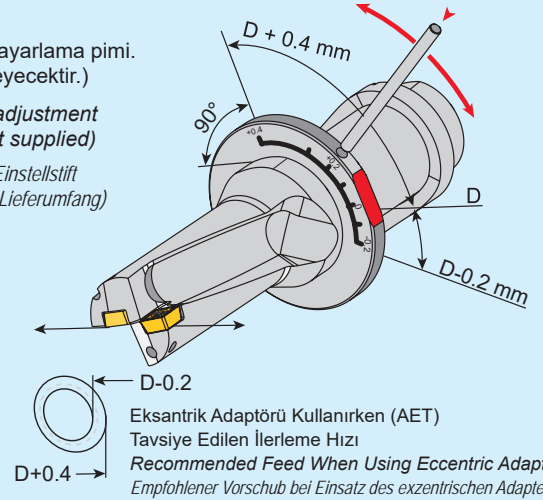

Delik Çapı  
 24.8 mm  
 Hole Diameter  
 Lochdurchmesser

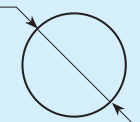

U-Drill Çapı = 25 mm  
 Drill Diameter = 25 mm  
 Vollbohrer Durchmesser = 25 mm

Delik Çapı  
 25 mm  
 Hole Diameter  
 Lochdurchmesser

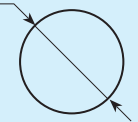

U-Drill Çapı = 25 mm  
 Drill Diameter = 25 mm  
 Vollbohrer Durchmesser = 25 mm

Delik Çapı  
 25.4 mm  
 Hole Diameter  
 Lochdurchmesser

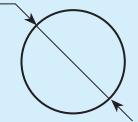

U-Drill Çapı = 25 mm  
 Drill Diameter = 25 mm  
 Vollbohrer Durchmesser = 25 mm

ATUM'un üzerindeki düz çizgi adaptörün sıfır rakamının üzerine konulmalıdır. AET'nin (eksantrik adaptörün) çevrilmesini kolaylaştırmak için AET'nin üzerindeki deliğe, metal bir çubuk ya da vida anahtarları yerleştirilebilir. AET'yi ayarlama öncesi tutucunun vidasını hafifçe çözün.

The adjustment markings should be located perpendicular to the flat on the circumference of the U-DRILL flange. To facilitate the rotation of the adaptor, a metal rod or a screw key may be inserted into a hole on the eccentric adaptor flange. Unlock adapter screw before adjusting adaptor.

Die Einstellmarkierung sollte senkrecht zur Fläche des Bohrerschäftes stehen. Zum Drehen des Adapters sollte ein Stift in die Bohrung am Adapterflansch eingesetzt werden. Lösen Sie die Adapter-Schraube vor dem Einstellen des Adapters.

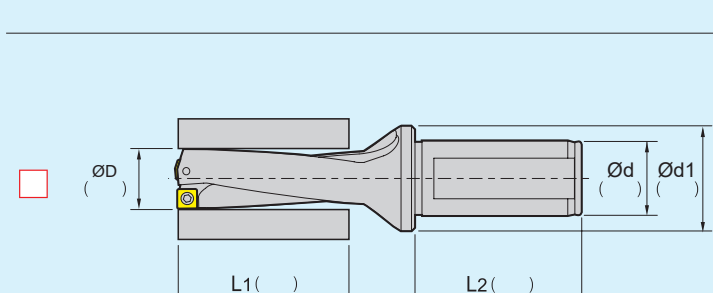
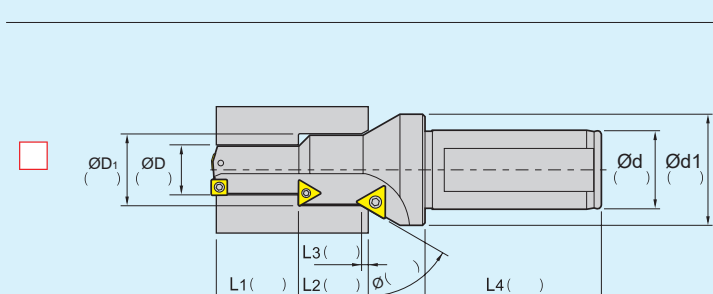
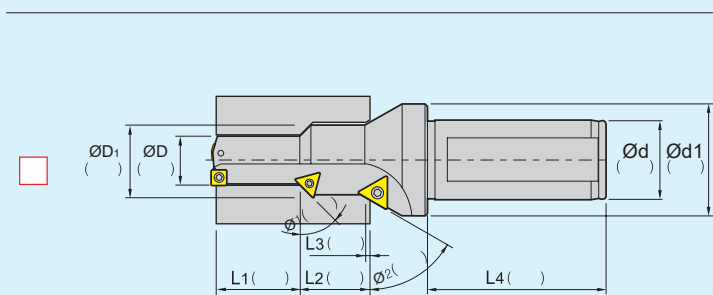
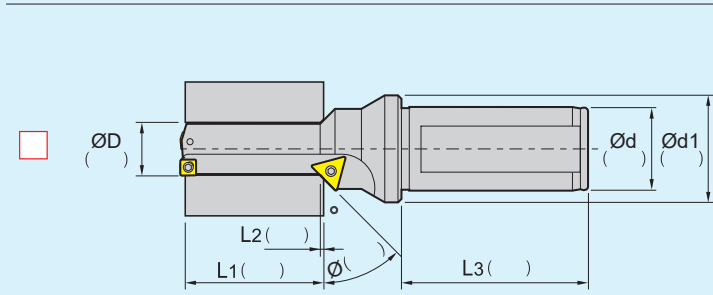
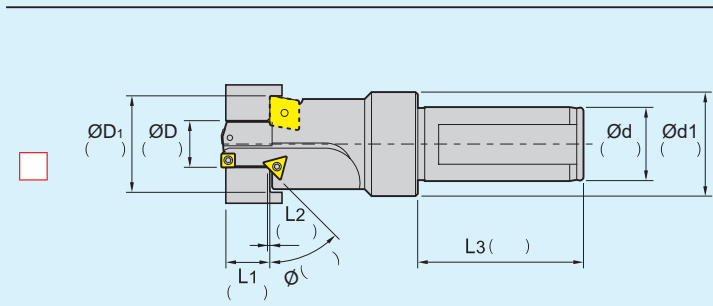

• Soğutma Tipi / Coolant type / Kühlmittelanschluss

Yağ Deliği Dalma Kismında

Oil Hole On the Plunge Part  
Kühlmittelzuführung über den Bund

Yağ Deliği Şaft Kismında

"Oil hole On the Shank"  
Kühlmittelbohrung durch den Schaft

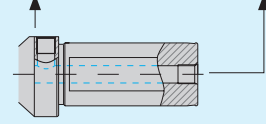

• Delik Tipi / Hole Type / Bohrungstyp

Kapalı Delik

Blind Hole  
Grundbohrung

Açık Delik

Thru Hole  
Durchgangsbohrung

• Şaft Tipleri / Types of Shank / Schaftausführung

**Düz Tip**  
Flat Type  
Bohrungstyp

**Weldon Tip**  
Weldon Type  
Weldon-Schaft

**Eğimli Yargı Tipi**  
Whistle Notch Type  
Whistle-Notch-Schaft

• Yargı Bağlama Yeri / Location of Side Lock / Position der Spannfläche

**Dış Uca Parellel (Standart)**  
Parallel to Peripheral Insert (Standard)  
Parallel zur äußeren Wendeplatte

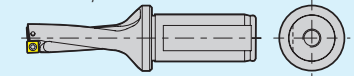

**Dış Uca 90° Açılı**  
90° angle to peripheral insert  
90° außen abgewinkelt

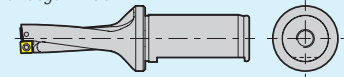

**Dış Uca 150° Açılı**  
150° angle to peripheral insert  
150° außen abgewinkelt

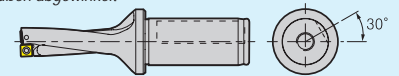

**Dış Uca 180° Açılı**  
180° angle to peripheral insert  
180° außen abgewinkelt

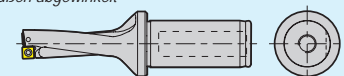

• Not / Note / Hinweis :

- Şu Anki Kullanılan Takım / Currently Using Tool
- Aktuell verwendetes Werkzeug
- Şu Anki Kesme Durumu / Current Cutting Condition
- Aktuelle Schnittbedingungen
  - RPM ya da vc(m/min) / - RPM or vc(m/min)
  - Umdrehungen pro Minute oder vc (m/min.)
  - vf(mm/min) ya da fn(mm/rev)
  - vf(mm/min) or fn(mm/rev) vf (mm/min.) oder fn (mm/Umdr.)
  - Kesme Derinliği / Depth of Cut(mm)
  - Schnitttiefe (mm)
- Ölçülen Standart Takım Ömrü / Standard of Measuring Tool Life
- Standzeit des Werkzeugs
- Şu Anki Kullanılan Makinalar / Currently Using Machine
- Aktuell eingesetzte Maschine
  - İşleme Merkezi / Machining Center
  - Bearbeitungszentrum
  - Genel Torna / General Lathe
  - Drehmaschine
  - CNC Torna / CNC Lathe
  - CNC-Drehmaschine



*konusulan*  
*the spoken kalite...*  
*quality...*

# EKONOMİK KESİCİLER

**EKONOMİK KESİCİLER**

*ECONOMIC CUTTING TOOLS*

*MULTIFUNKTIONALES DREH- UND BOHRWERKZEUG*







AKKO **A** **EK** **R** - **D2.25** x **20**

**X** **C** . . **10** **T3** **04**

**2** Kesiş Stili / Cutter Style / Werkzeugtyp  
EK : Ekonomik Kesici / Economic Cutting  
Multifunktionales Dreh- und Bohrwerkzeug

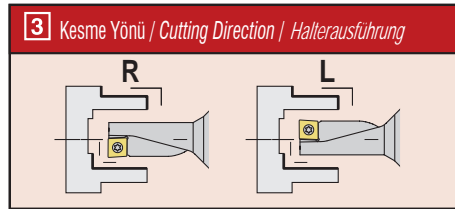

**11** Kalınlık / Thickness / Dicke

01 s = 1.59  
T1 s = 1.98  
02 s = 2.38  
T2 s = 2.78  
03 s = 3.18  
T3 s = 3.97  
04 s = 4.76  
05 s = 5.56  
06 s = 6.35  
07 s = 7.94  
09 s = 9.52

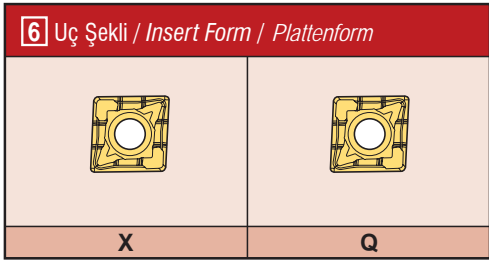
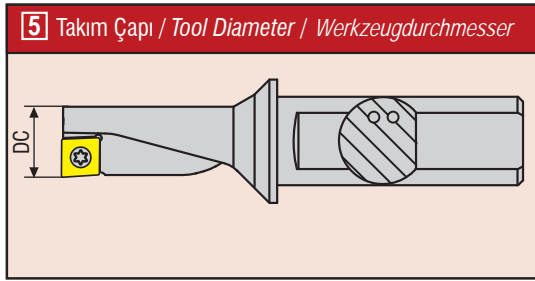
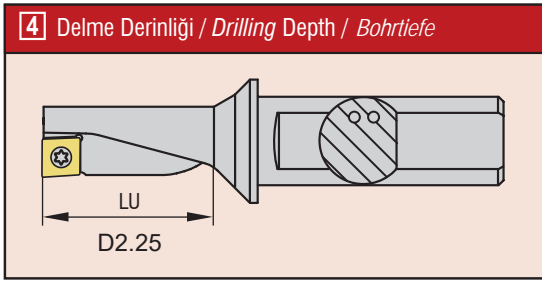

**8** Toleranslar / Tolerance Classes / Toleranzen

	IC	M	S
A	± 0.025	± 0.005	± 0.025
C	± 0.025	± 0.013	± 0.025
E	± 0.025	± 0.025	± 0.025
F	± 0.013	± 0.005	± 0.025
G	± 0.025	± 0.025	± 0.130
H	± 0.013	± 0.013	± 0.025
J	± 0.05-0.15	± 0.005	± 0.025
K	± 0.05-0.15	± 0.013	± 0.025
L	± 0.05-0.15	± 0.025	± 0.025
M	± 0.05-0.15	± 0.08-0.20	± 0.130
N	± 0.05-0.15	± 0.08-0.20	± 0.025
U	± 0.08-0.25	± 0.13-0.38	± 0.130

IC: Daire Ölçüsü / Inscribed Circle  
M: Şekle Göre / Refer to Figure  
S: Kalınlık / Thickness

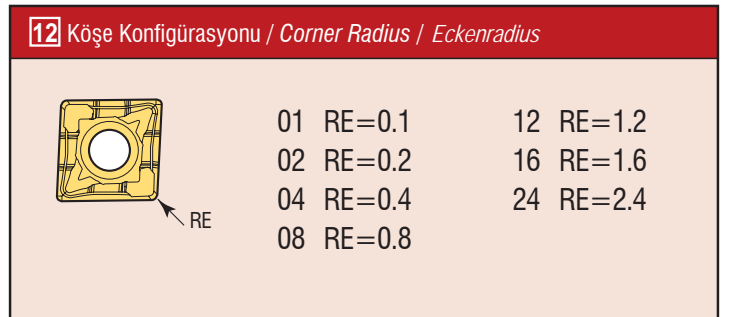
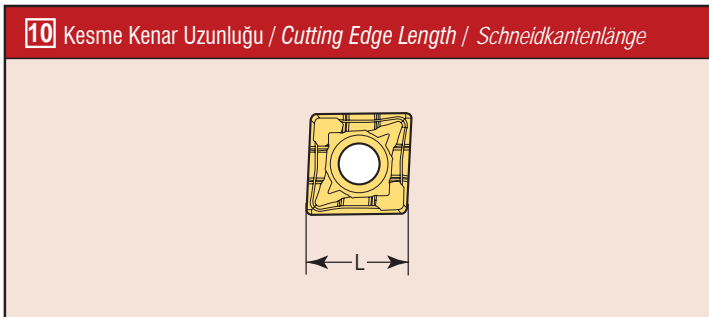
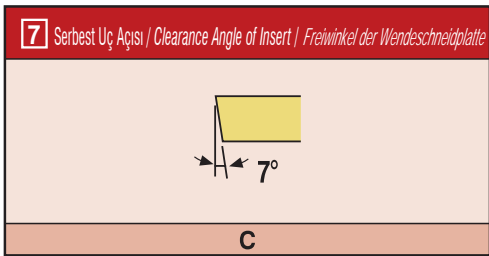
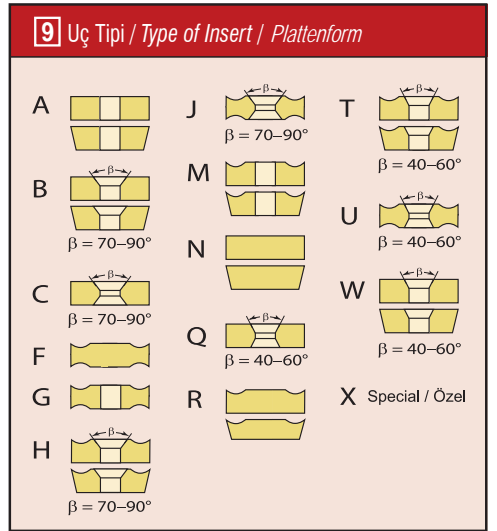

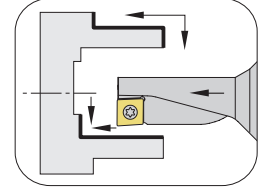
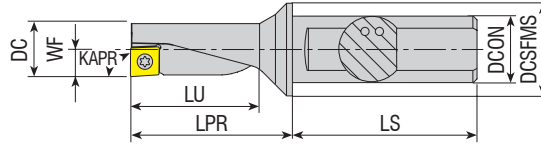

**Takım Kodu**  
**Ordering Code**  
**Bestell-Bezeichnung**

Stok  
Stock  
Lager

Takım Ölçüleri (mm)  
Dimension (mm)  
Abmessung (mm)

Kesici Uç  
Insert  
Wendeschneidplatte

Yedek Parçaları / Spare Parts / Ersatzteile

Sıkma Vidası  
Screw  
Schraube

Tork Anahtar  
Torx Key  
Torx-Schlüssel

R	L	DC	DCON	DCSFMS	LU	LPR	LS	WF	Kesici Uç Insert Wendeschneidplatte	Sıkma Vidası Screw Schraube	Tork Anahtar Torx Key Torx-Schlüssel
●	●	8	10	12	18	22	38	4	<b>XC.. 040104</b>	3006-M1.8x4	80-T06
●	●	10	12	16	22.5	27.5	42	5	<b>XC.. 050204</b>	3006-M2x4	80-T07
●	●	12	16	20	27	33	45	6	<b>XC.. 060204</b>	3007-M2.2x5	80-T08
●	●	14	16	20	31.5	38	45	7	<b>XC.. 070304</b>	3008-M2.5x6	80-T15
●	●	16	20	25	36	44	50	8	<b>XC.. 080304</b>	3008-M3x6	80-T20
●	●	18	25	32	40.5	53.5	56	9	<b>XC.. 09T304</b>	4015-M3.5x9	80-T15
●	●	20	25	32	45	55	56	10	<b>XC.. 10T304</b>	4020-M4.5x10	80-T20
●	●	25	32	40	56.5	69	60	12.5	<b>XC.. 130404</b>	4020-M4.5x10	80-T20
●	●	32	32	50	72	88	60	16	<b>XC.. 170504</b>	4020-M4.5x12	80-T20

R: Sağ / Right / Rechts L: Sol/Left/Links

● Stokta / In Stock / Auf Lager ○ Stokta Yok / Non Stock Item / Kein Lagerartikel, Lieferzeit auf Anfrage

CRTZT-ISCR-TGTC-KRLY Ucuna Uygundur. / Compatible with CRTZT-ISCR-TGTC-KRLY Insert.

Kompatibel mit CRTZT-ISCR-TGTC-KRLY Wendeplatten.

Sipariş Örneği/Ordering Example/Bestellbeispiel  
 1 ad./pcs./stück AEKR-D2.25X8 XC.. 040104

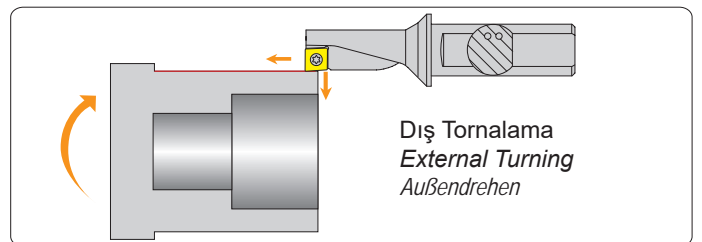
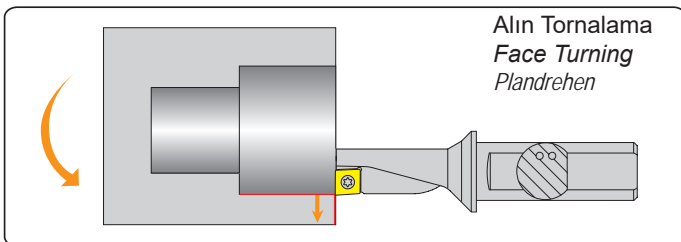
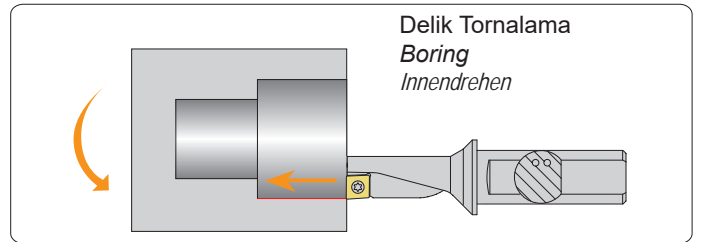
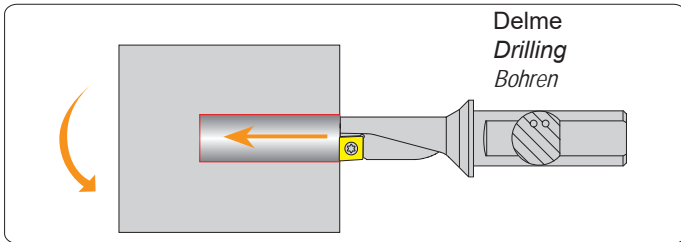
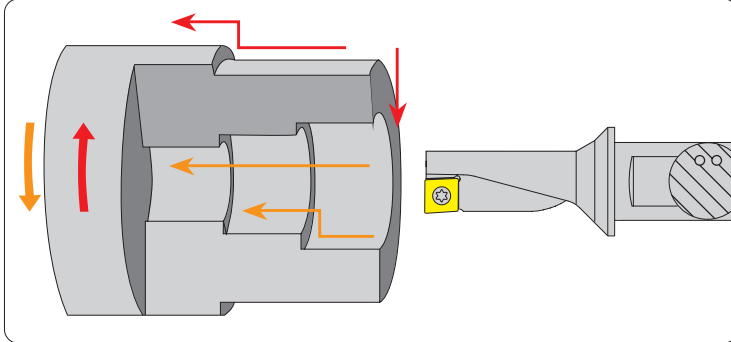

# BARALAR

**AYARLI DELİK İŞLEME BARALARI**  
ADJUSTABLE BORING HEADS  
EINSTELBARE SPINDELKÖPFE

*konusulan*  
*the spoken kalite...*  
*quality...*

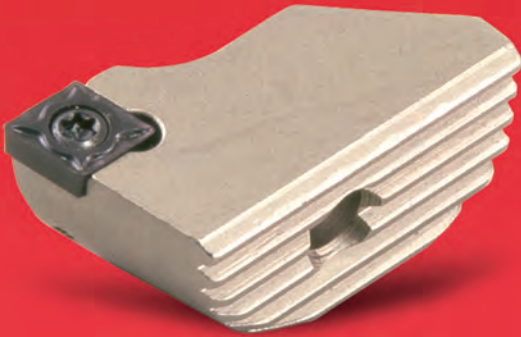

AKKO

A

1

BH

2

R

3

D18x22

4

W16

5

L90

6

CC06

7

2 Kesiş Stili / Cutter Style / Werkzeugtyp

BH : Delik İşleme / Boring Head  
Spindelkopf

3 İşlem Tipi / Cutter Type / Einsatzgebiet

R : Kaba Baralama / Rough Boring  
Schruppbearbeitung  
F : Hassas Baralama / Fine Boring  
Schlichtbearbeitung

5 Montaj Formu / Assembly Form / Schaftform

W : Weldon

4 Ölçü Aralığı / Boring Range / Bohrbereich

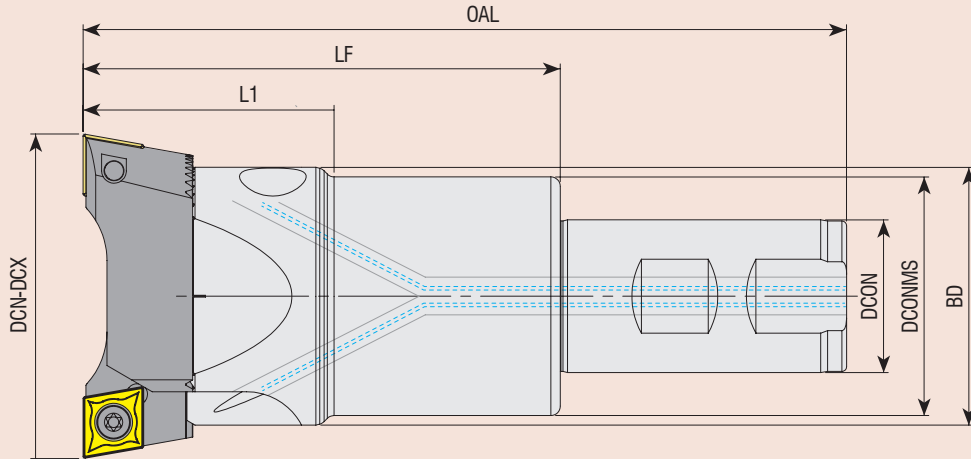

6 Takım Boyu / Tool Length / Werkzeuglänge

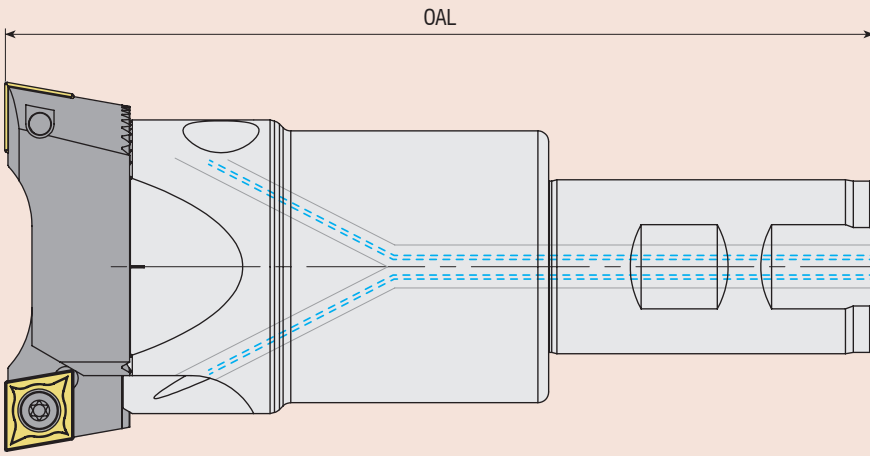

7 Kesici Uç / Insert / Wendeschneidplatte

CC06 : CC.. 0602..  
CC09 : CC.. 09T3..  
CC12 : CC.. 1204..



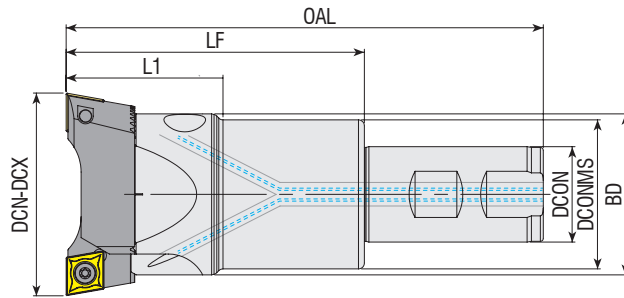

DIN 1835

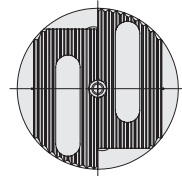

**Takım Kodu**  
**Ordering Code**  
**Bestell-Bezeichnung**

Stok  
Stock  
Lager

Takım Ölçüleri (mm)  
Dimension (mm)  
Abmessung (mm)

Kartuş  
Cartridge  
Kurzrehthalter

Bara Gövde Takım Kodu  
Boring Head Body Code  
Trägerwerkzeug-Bezeichnung

Ölçü Aralığı  
Boring Range  
Bohrbereich  
DCN-DCX

DCON DCONMS BD OAL LF L1

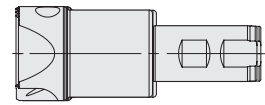
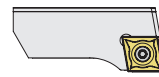

Takım Kodu Ordering Code Bestell-Bezeichnung	Stok Stock Lager	Ölçü Aralığı Boring Range Bohrbereich DCN-DCX	DCON	DCONMS	BD	OAL	LF	L1	Kartuş Cartridge Kurzrehthalter	Bara Gövde Takım Kodu Boring Head Body Code Trägerwerkzeug-Bezeichnung
ABHR-D18x22-W16-L90-CC06	●	18-22	16	-	-	90	42	-	AK.. 18-22	ABHRS-D16x42-W16-L90
ABHR-D18x22-W16-L150-CC06	●	18-22	16	-	-	150	102	-		ABHRS-D16x102-W16-L150
ABHR-D18x22-W16-L200-CC06	●	18-22	16	-	-	200	152	-		ABHRS-D16x152-W16-L200
ABHR-D22x28-W20-L100-CC06	●	22-28	20	-	-	100	50	-	AK.. 22-28	ABHRS-D20x50-W20-L100
ABHR-D22x28-W20-L150-CC06	●	22-28	20	-	-	150	100	-		ABHRS-D20x100-W20-L150
ABHR-D22x28-W20-L200-CC06	●	22-28	20	-	-	200	150	-		ABHRS-D20x150-W20-L200
ABHR-D28x38-W20-L110-CC06	●	28-38	20	25	-	110	60	-	AK.. 28-38	ABHRS-D25x60-W20-L110
ABHR-D28x38-W20-L160-CC06	●	28-38	20	25	-	160	110	-		ABHRS-D25x110-W20-L160
ABHR-D28x38-W20-L230-CC06	●	28-38	20	25	-	230	180	-		ABHRS-D25x180-W20-L230
ABHR-D36x50-W25-L120-CC06	●	36-50	25	32	-	120	64	-	AK.. 36-50	ABHRS-D32X64-W25-L120
ABHR-D36x50-W25-L170-CC06	●	36-50	25	32	-	170	114	-		ABHRS-D32X114-W25-L170
ABHR-D36x50-W25-L250-CC06	●	36-50	25	32	-	250	194	-		ABHRS-D32X194-W25-L250
ABHR-D36x50-W25-L120-CC09	●	36-50	25	32	-	120	64	-	AK.. 36-50-09	ABHRS-D32X64-W25-L120
ABHR-D36x50-W25-L170-CC09	●	36-50	25	32	-	170	114	-		ABHRS-D32X114-W25-L170
ABHR-D36x50-W25-L250-CC09	●	36-50	25	32	-	250	194	-		ABHRS-D32X194-W25-L250
ABHR-D50x68-W32-L140-CC09	●	50-68	32	40	-	140	80	-	AK.. 50-68	ABHRS-D40x80-W32-L140
ABHR-D50x68-W32-L200-CC09	●	50-68	32	40	-	200	140	-		ABHRS-D40x140-W32-L200
ABHR-D50x68-W32-L280-CC09	●	50-68	32	40	-	280	220	-		ABHRS-D40x220-W32-L280
ABHR-D50x68-W32-L140-CC12	●	50-68	32	40	-	140	80	-	AK.. 50-68-12	ABHRS-D40x80-W32-L140
ABHR-D50x68-W32-L200-CC12	●	50-68	32	40	-	200	140	-		ABHRS-D40x140-W32-L200
ABHR-D50x68-W32-L280-CC12	●	50-68	32	40	-	280	220	-		ABHRS-D40x220-W32-L280
ABHR-D68x90-W32-L160-CC12	●	68-90	32	50	54	160	100	50	AK.. 68-90	ABHRS-D50x100-W32-L160
ABHR-D68x90-W32-L210-CC12	●	68-90	32	50	54	210	150	50		ABHRS-D50x150-W32-L210
ABHR-D68x90-W32-L280-CC12	●	68-90	32	50	54	280	220	50		ABHRS-D50x220-W32-L280
ABHR-D90x120-W32-L140-CC12	●	90-120	32	63	72	140	80	63	AK.. 90-120	ABHRS-D63x80-W32-L140
ABHR-D90x120-W40-L200-CC12	●	90-120	40	63	72	200	130	63		ABHRS-D63x130-W40-L200
ABHR-D90x120-W40-L300-CC12	●	90-120	40	63	72	300	230	63		ABHRS-D63x230-W40-L300
ABHR-D120x160-W40-L210-CC12	●	120-160	40	80	95	210	140	75	AK.. 120-160	ABHRS-D80x140-W40-L210
ABHR-D120x160-W40-L300-CC12	●	120-160	40	80	95	300	230	75		ABHRS-D80x230-W40-L300
ABHR-D160x200-W40-L210-B-CC12	●	160-200	40	80	95	210	140	75	AK.. 160-800	ABHRS-D80x140-W40-L210
ABHR-D160x200-W40-L300-B-CC12	●	160-200	40	80	95	300	230	75		ABHRS-D80x230-W40-L300

R: Sağ / Right / Rechts L: Sol/Left/Links

● Stokta / In Stock / Auf Lager ○ Stokta Yok / Non Stock Item / Kein Lagerartikel, Lieferzeit auf Anfrage  
Siparişte, gövde ve kartuş set olarak verilecektir. / When ordered, body and cartridge will be sent as set.  
Bei Bestellung werden Körper und Kassetten als Set geliefert.

Sipariş Örneği/Ordering Example/Bestellbeispiel  
1 ad./pcs./stück ABHR-D18x22-W16-L90-CC06

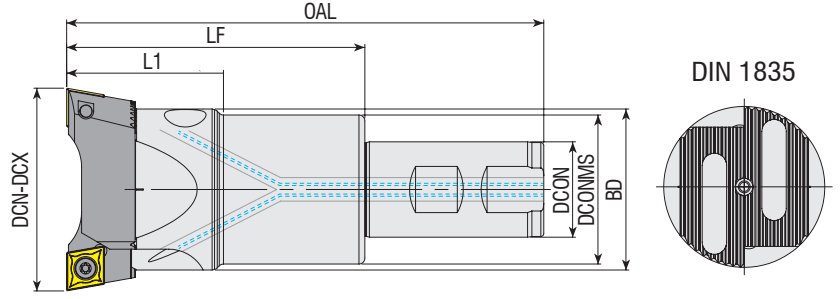

DIN 1835

**Takım Kodu**  
**Ordering Code**  
**Bestell-Bezeichnung**

Stok  
Stock  
Lager

Ölçü Aralığı  
Boring Range  
Bohrbereich  
DCN-DCX

Takım Ölçüleri (mm)  
Dimension (mm)  
Abmessung (mm)

DCON DCONMS BD OAL LF L1

Yedek Parçaları / Spare Parts / Ersatzteile

Montaj Vidası  
Mounting Screw  
Befestigungsschraube

Montaj Vida Anahtarı  
Mounting Screw Key  
Innenbohrschlüssel

Pabuç  
Clamp  
Spannspratze

Ayar Vidası  
Adjusting Screw  
Einstellschraube

Ayar Vida Anahtarı  
Allen Key  
Innensechskant-Schlüssel

Takım Kodu Ordering Code Bestell-Bezeichnung	Stok Stock Lager	Ölçü Aralığı Boring Range Bohrbereich DCN-DCX	DCON	DCONMS	BD	OAL	LF	L1	Montaj Vidası Mounting Screw Befestigungsschraube	Montaj Vida Anahtarı Mounting Screw Key Innenbohrschlüssel	Pabuç Clamp Spannspratze	Ayar Vidası Adjusting Screw Einstellschraube	Ayar Vida Anahtarı Allen Key Innensechskant-Schlüssel
ABHRS-D16x42-W16-L90	●	18-22	16	-	-	90	42	-					
ABHRS-D16x102-W16-L150	●	18-22	16	-	-	150	102	-	2525-M3x14	AAL-02-2.5	ABKS-D16	2715-M3x4	
ABHRS-D16x152-W16-L200	●	18-22	16	-	-	200	152	-					
ABHRS-D20x50-W20-L100	●	22-28	20	-	-	100	50	-					
ABHRS-D20x100-W20-L150	●	22-28	20	-	-	150	100	-	2503-M4x15	AAL-03-3	ABKS-D20	2715-M3x5	AAL-09-1.5
ABHRS-D20x150-W20-L200	●	22-28	20	-	-	200	150	-					
ABHRS-D25x60-W20-L110	●	28-38	20	25	-	110	60	-					
ABHRS-D25x110-W20-L160	●	28-38	20	25	-	160	110	-	2503-M4x20	AAL-03-3	ABKS-D25	2715-M3x8	
ABHRS-D25x180-W20-L230	●	28-38	20	25	-	230	180	-					
ABHRS-D32X64-W25-L120	●	36-50	25	32	-	120	64	-					
ABHRS-D32X114-W25-L170	●	36-50	25	32	-	170	114	-	2504-M5x25	AAL-05-4	ABKS-D32	2702-M4x12	AAL-01-2
ABHRS-D32X194-W25-L250	●	36-50	25	32	-	250	194	-					
ABHRS-D40x80-W32-L140	●	50-68	32	40	-	140	80	-					
ABHRS-D40x140-W32-L200	●	50-68	32	40	-	200	140	-	2505-M6x30	AAL-07-5	ABKS-D40	2725-M5x16	
ABHRS-D40x220-W32-L280	●	50-68	32	40	-	280	220	-					AAL-02-2.5
ABHRS-D50x100-W32-L160	●	68-90	32	50	54	160	100	50					
ABHRS-D50x150-W32-L210	●	68-90	32	50	54	210	150	50	2506-M8x35	AAL-08-6	ABKS-D50	2725-M5x12	
ABHRS-D50x220-W32-L280	●	68-90	32	50	54	280	220	50					
ABHRS-D63x80-W32-L140	●	90-120	32	63	72	140	80	63					
ABHRS-D63x130-W40-L200	●	90-120	40	63	72	200	130	63	2508-M10x40	AAL-11-8	ABKS-D63	2703-M6x16	AAL-03-3
ABHRS-D63x230-W40-L300	●	90-120	40	63	72	300	230	63					
ABHRS-D80x140-W40-L210	●	120-160	40	80	95	210	140	75	2510-M12x40				
ABHRS-D80x230-W40-L300	●	120-160	40	80	95	300	230	75					
ABHRS-D80x140-W40-L210	●	160-200	40	80	95	210	140	75	2510-M12x40	AAL-12-10	ABKS-D80	2704-M8x25	AAL-05-4
ABHRS-D80x230-W40-L300	●	160-200	40	80	95	300	230	75					

R: Sağ / Right / Rechts L: Sol/Left/Links

● Stokta / In Stock / Auf Lager ○ Stokta Yok / Non Stock Item / Kein Lagerartikel, Lieferzeit auf Anfrage

Sipariş Örneği/Ordering Example/Bestellbeispiel

1 ad./pcs./stück ABHRS-D16x42-W16-L90

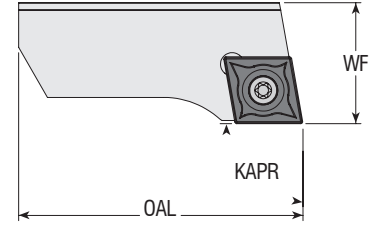

Takım Kodu Ordering Code Bestell-Bezeichnung	Stok Stock Lager	Takım Ölçüleri (mm) Dimension (mm) Abmessung (mm)		Kesici Uç Insert Wendeschneidplatte	Yedek Parçaları / Spare Parts / Ersatzteile		
		Ölçü Aralığı Boring Range	WF		OAL	Sıkma Vidası Screw Schraube	Tork Anahtar Torx Key Torx-Schlüssel
AKSR 18-22	●	18-22	9	15	CC.. 0602..	4008-M2.5x6	80-T08
AKSR 22-28	●	22-28	10	19			
AKSR 28-38	●	28-38	13	23			
AKSR 36-50	●	36-50	16	32	CC.. 09T3..	4015-M3.5x8	80-T15
AKSR 36-50-09	●	36-50	16	32			
AKSR 50-68	●	50-68	20	40			
AKSR 50-68-12	●	50-68	20	40	CC.. 1204..	1020-M5x11	80-T20
AKSR 68-90	●	68-90	23	54			
AKSR 90-120	●	90-120	28	70			
AKSR 120-160	●	120-160	32	95			
AKSR 160-800	●	160-800	32	120			

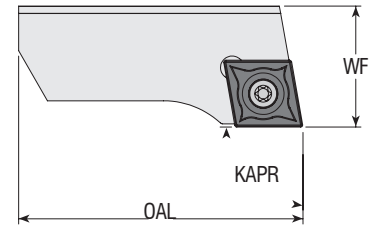

Takım Kodu Ordering Code Bestell-Bezeichnung	Stok Stock Lager	Takım Ölçüleri (mm) Dimension (mm) Abmessung (mm)		Kesici Uç Insert Wendeschneidplatte	Yedek Parçaları / Spare Parts / Ersatzteile		
		Ölçü Aralığı Boring Range	WF		OAL	Sıkma Vidası Screw Schraube	Tork Anahtar Torx Key Torx-Schlüssel
AKCR 28-38	●	28-38	12.8	23	CC.. 0602..	4008-M2.5x6	80-T08
AKCR 36-50	●	36-50	15.8	32			
AKCR 36-50-09	●	36-50	15.8	32			
AKCR 50-68	●	50-68	19.7	40	CC.. 09T3..	4015-M3.5x8	80-T15
AKCR 50-68-12	●	50-68	19.7	40			
AKCR 68-90	●	68-90	22.7	54			
AKCR 90-120	●	90-120	27.7	70	CC.. 1204..	1020-M5x11	80-T20
AKCR 120-160	●	120-160	31.7	95			
AKCR 160-800	●	160-800	31.7	120			

R: Sağ / Right / Rechts L: Sol/Left/Links  
● Stokta / In Stock / Auf Lager ○ Stokta Yok / Non Stock Item / Kein Lagerartikel, Lieferzeit auf Anfrage  
ISO Ucuna Uygunudur. / Compatible with ISO Insert. / Kompatibel mit ISO Wendeplatten.

Sipariş Örneği/Ordering Example/Bestellbeispiel  
1 ad./pcs./stück AKSR 18-22

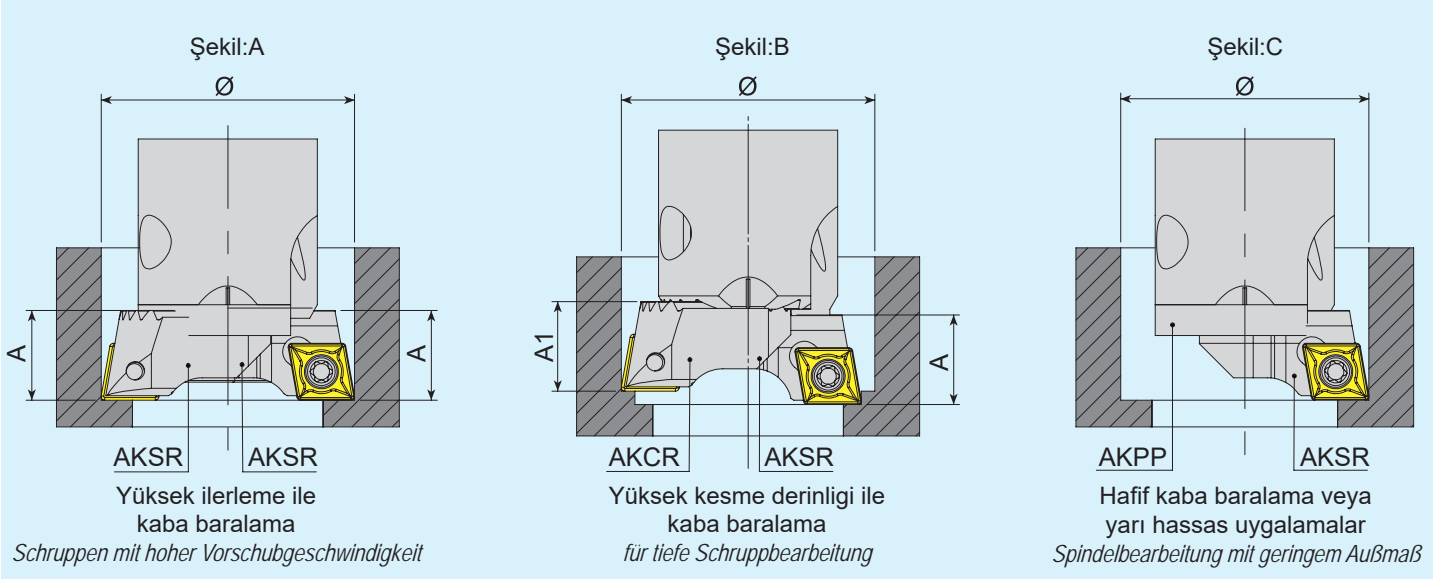

1. Kesici kenarların radyal ayarı, takım ölçme ekipmanı ile yapılmalıdır.
2. İki uçlu baralama takımı, ağır talaş kaldırma işlemini içeren kaba baralama işlemleri içindir.  
Çift uçlu baralama takımı ile:
  - Yüksek ilerleme oranında kaba baralama işlemleri için, aynı düzlemdaki iki AKSR kartuşu, aynı radyal mesafeye ayarlanır. (Şekil A)
  - Aynı düzlemde olmayan bir AKCR kartuşu ve bir AKSR kartuşu yüksek derinlikte kaba baralama işlemleri için kullanılır. (Şekil B)
    - i. Kaba baralama işleminde, alınacak paso miktarı tam olarak ikiye bölünüp, düzgün bir kesim sağlanmış olur, ancak bu durumda tur başına ilerleme tek ağız olarak hesaplanmalıdır. ( $f=f1$ )
    - ii. Hassas baralama işleminde, alınacak paso miktarı AKSR kartuş için ara kaba olarak ve AKCR kartuş için hassas bara olarak çaplar ayarlanır ve bu sayede bazı ara kaba işleme ihtiyacı kalmaz.
3. Tek kartuşlu baralama takımları, normal talaş kaldırma işlemini içeren kaba ve hassas baralama işlemleri içindir. Dişleri koruma plakası, AKPP daima kullanılmalıdır. (Şekil C)

1. Radial setting of the cutting edges should be carried out with tool presetting equipment.
2. Boring bars fitted with two insert pockets are for roughing operations involving heavy chip removal.  
The double-insert boring bars include:
  - Two AKSR cartridges on the same plane with two cutting edges set at identical radial distance for high feed rate roughing operations. (fig. A)
  - An AKCR cartridge and an AKSR cartridge not on the same plane for high-depth roughing operations. (fig. B)
    - i. With the rough boring operation, this allows double the cutting width, using only a single feed rate. ( $f=f1$ )
    - ii. With the finish boring operation, the cutting width is divided so that some of the intermediate machining can be omitted.
3. Boring bars fitted with a single cartridge are for roughing and finishing operations involving normal chip removal. The serrated surface protection plate AKPP should always be used (fig. C)

1. Die radiale Einstellung der Schneiden sollte auf einem Voreinstellgerät durchgeführt werden.
2. Spindelköpfe, die mit 2 Kassetten bestückt sind, werden für die Schruppbearbeitung eingesetzt.  
Doppelte Kassetten beinhalten:
  - Für die Schruppbearbeitung mit hoher Vorschubgeschwindigkeit sind zwei AKSR-Kassetten in derselben Höhe auf denselben radialen Abstand einzustellen (Abbildung A)
  - Eine AKCR-Kassette und eine AKSR-Kassette, die nicht in derselben Ebene liegen, werden für tiefe Schruppbearbeitungen eingesetzt.
    - i. Bei einer Schruppbearbeitung kann die Schnitttiefe verdoppelt werden. Bitte nur eine Schneide zur Vorschubberechnung verwenden ( $f=f1$ ).
    - ii. Bei der Schlichtbearbeitung wird die Schnitttiefe halbiert. Weitere zusätzliche Bearbeitungsdurchgänge werden überflüssig.
3. Bohrköpfe mit einer einzelnen Kassette können sowohl für Schlicht- als auch für Schrupp-Operationen eingesetzt werden. Voraussetzung hierfür ist eine gute Spanabfuhr. Zum Schutz der verzahnten Oberfläche des Bohrkörpers sollte immer die Abdeckung AKPP verwendet werden (siehe Abb.C).





*konusulan*  
*the spoken kalite...*  
*quality...*

**FREZELEME TAKIMLARI**  
**MILLING TOOLS**  
**FRÄSWERKZEUGE**



AKKO **A** **EM** **90** **L** - **A** **P** **10**

1 2 3 4 5 6 7

**D12** - **W16** - **L100** - **Z01** - **H**

8 9 10 11 12

## 2 Kesiş Stili / Cutter Style / Fräs Werkzeug-Typ

FM: Yüzey Frezeleme Takımları / Face Milling Tools / Eck-und Planfräsköpfe  
EM: Alın ve Yüzey Parmak Frezeleri / End Face Milling Tools / Schafffräser  
CM: Pah Kırma Parmak Frezeleri / Chamfering End Milling Tools / Fasfräser  
HM: Helis Parmak Frezeleri / Helix End Milling Tools / Schafffräser Helix  
TSM: T Kanal Frezeleri / T Slot Milling Tools / T-Nutenfräser  
HFM: Yüksek İlerleme Frezeleme Takımları / High Feed Milling Tools / Fräser für hohe Vorschübe  
PMR: Küresel Uçlu Parmak Frezeleri / Ball Nose End Milling Tools / Kugel und Kopierfräser  
SDM: Disk Frezeler / Slot Disc Milling / Scheibenfräser  
CBM: Silindirik Alyan Başlı Vida Havşalarını Açma Frezeleri / Countersink Milling Tool for Cylindrical Allen Head Screws  
Fräs Werkzeug für zylindrische Inbusschrauben

## 3 Freze Yanaşma Açısı / Lead Angle / Anstellwinkel

90° - 75° - 60° - 45°  
20° - 15° - 11° - 5° - 0°

## 4 Freze Yanaşma Açısı / Lead Angle / Ausführung

L: Sol - Left / Links  
C: Baskı Pabucu - Clamp / Spannpratze  
S: Altlık - Shim / Unterlage  
CL: Baskı Pabuçlu Sol Yön - Left Way with Clamp  
Spannpratze links  
CS: Baskı Pabuçlu Altlık - Clamp with Shim  
Spannpratze mit Unterlage  
CSL: Baskı Pabuçlu Altlık Sol Yön - Left Way Clamp with Shim  
Spannpratze mit Unterlage Links

## 5 Uç Tipi / Type of Insert / Plattenform

<b>C</b>	<b>D</b>	<b>E</b>	<b>K</b>
<b>L</b>	<b>R</b>	<b>S</b>	<b>T</b>
<b>V</b>	<b>W</b>	<b>A</b>	<b>B</b>
<b>H</b>	<b>M</b>	<b>O</b>	<b>P</b>

## 6 Serbest Uç Açısı / Clearance angle of Insert Freiwinkel der Wendeschneidplatte

<b>A</b>	<b>B</b>	<b>C</b>
<b>D</b>	<b>E</b>	<b>F</b>
<b>G</b>	<b>N</b>	<b>P</b>

## 7 Kesme Kenar Uzunluğu Cutting Edge Length Länge der Schneidkante

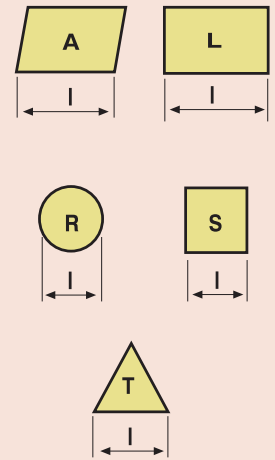

## 8 Takım Çapı / Tool Diameter / Werkzeug-ø

## 9 Montaj Formu ve Çapı / Assembly Form and Diameter / Schaft-ø und Form

A,B,C,D: ISO'ya göre montaj formu / Assembly Form and Diameter / Art der Montage und Durchmesser  
C: Silindirik Şaft / Cylindrical Shank / Zylindrischer Schaft  
W: Weldon

## 10 Takım Boyu / Tool Length / Werkzeug Länge

## 11 Etkili Diş Adedi / Number of Effective Tooth / Effektive Zähnezahl

## 12 İçten Soğutmalı / With Coolant Hole / Innenkühlung

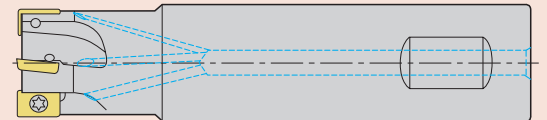

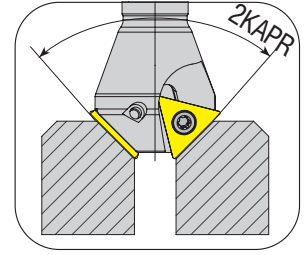
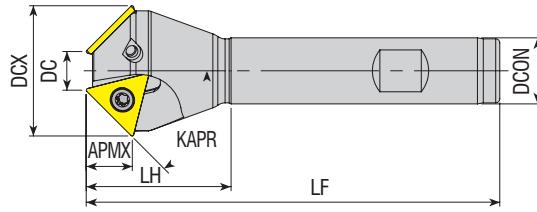

**Takım Kodu**  
**Ordering Code**  
*Bestell-Bezeichnung*

Stok  
Stock  
Lager

Takım Ölçüleri (mm)  
Dimension (mm)  
Abmessung (mm)

Kesici Uç  
Insert  
Wendeschneidplatte

Yedek Parçaları / Spare Parts / Ersatzteile

Sıkma Vidası  
Screw  
Schraube

Tork Anahtar  
Torx Key  
Torx-Schlüssel

KAPR	DC	DCX	DCON	LF	LH	ZEPF	APMX
------	----	-----	------	----	----	------	------



ACM10-TC16-D17X22-W16-L90-Z01	●	10°	17	22	16	90	30	1	15.2	TC.T 16T304	4015-M3.5x9	80-T15	
ACM15-TC16-D17X24-W16-L90-Z01	●	15°	17	24	16	90	30	1	14.9				
ACM15-TC16-D22X29-W16-L100-Z01	●	15°	22	29	16	100	30	1	14.9				
ACM15-TC16-D30X37-W20-L100-Z02	●	15°	30	37	20	100	35	2	14.9				
ACM15-TC16-D35X42-W20-L100-Z03	●	15°	35	42	20	100	38	3	14.9				
ACM15-TC16-D52X59-W25-L110-Z03	●	15°	52	59	25	110	40	3	14.9				
ACM17.5-TC16-D17X25-W16-L90-Z01	●	17.5°	17	25	16	90	30	1	14.7				
ACM18.5-TC16-D21.3X30-W20-L100-Z02	●	18.5°	21.3	30	20	100	30	2	13.5				TC.T 16T308
ACM20-TC16-D12X22-W16-L100-Z01	●	20°	12	22	16	100	30	1	14.4				
ACM20-TC16-D17X27-W16-L100-Z01	●	20°	17	27	16	100	30	1	14.4				
ACM20-TC16-D23X33-W20-L100-Z02	●	20°	23	33	20	100	30	2	14.4				
ACM20-TC16-D28X38-W20-L100-Z02	●	20°	28	38	20	100	35	2	14.4				
ACM20-TC16-D35X45-W20-L100-Z03	●	20°	35	45	20	100	40	3	14.4				
ACM20-TC16-D39X49-W20-L100-Z03	●	20°	39	49	20	100	40	3	14.4				
ACM20-TC16-D45X55-W25-L110-Z03	●	20°	45	55	25	110	40	3	14.4				
ACM20-TC16-D51X61-W25-L110-Z03	●	20°	51	61	25	110	40	3	14.4				
ACM22.5-TC16-D17X28-W16-L100-Z01	●	22.5°	17	28	16	100	30	1	14.2				
ACM25-TC16-D17X29-W16-L100-Z01	●	25°	17	29	16	100	30	1	13.9				
ACM30-TC16-D6X20-W16-L100-Z01	●	30°	6	20	16	100	30	1	13.3				
ACM30-TC16-D15X30-W16-L100-Z01	●	30°	15	30	16	100	30	1	13.3				
ACM30-TC16-D17.5X32.5-W20-L100-Z02	●	30°	17.5	32.5	20	100	30	2	13.3				
ACM30-TC16-D20X35-W16-L100-Z02	●	30°	20	35	16	100	35	2	13.3				
ACM30-TC16-D30X45-W20-L100-Z02	●	30°	30	45	20	100	40	2	13.3				
ACM30-TC16-D35X50-W20-L100-Z03	●	30°	35	50	20	100	40	3	13.3				
ACM30-TC16-D45X60-W25-L110-Z03	●	30°	45	60	25	110	40	3	13.3				
ACM45-TC09-D7X18-W16-L100-Z02	●	45°	7	18	16	100	25	2	5.9	TC.T 090204	3007-M2.2x5	80-T07	
ACM45-TC11-D11X24-W16-L100-Z02	●	45°	11	24	16	100	25	2	6.9	TC.T 110204	3008-M2.5x6	80-T08	
ACM45-TC16-D5X26-W16-L100-Z01	●	45°	5	26	16	100	30	1	10.8	TC.T 16T304	4015-M3.5x9	80-T15	
ACM45-TC16-D10X31-W16-L100-Z02	●	45°	10	31	16	100	35	2	10.8				
ACM45-TC16-D10X31-W20-L100-Z02	●	45°	10	31	20	100	35	2	10.8				
ACM45-TC16-D18X39-W16-L100-Z02	●	45°	18	39	16	100	40	2	10.8				
ACM45-TC16-D18X39-W20-L100-Z02	●	45°	18	39	20	100	40	2	10.8				
ACM45-TC16-D20X41-W20-L100-Z02	●	45°	20	41	20	100	40	2	10.8				
ACM45-TC16-D30X51-W20-L100-Z02	●	45°	30	51	20	100	40	2	10.8				
ACM55-TC16-D16X40-W20-L100-Z03	●	55°	16	40	20	100	40	3	8.7				
ACM62-TC16-D14X40-W20-L100-Z03	●	62°	14	40	20	100	40	3	7.1				
ACM72-TC16-D14X42-W20-L100-Z03	●	72°	14	42	20	100	40	3	4.6				

R: Sağ / Right / Rechts L: Sol/Left/Links

● Stokta / In Stock / Auf Lager ○ Stokta Yok / Non Stock Item / Kein Lagerartikel, Lieferzeit auf Anfrage

ISO Ucuna Uygundur. / Compatible with ISO Insert. Kompatibel mit ISO Wendepplatten.

Sipariş Örneği/Ordering Example/Bestellbeispiel

1 ad./pcs./stück ACM10-TC16-D17X22-W16-L90-Z01

Kesme Hesabı : S 367 / Cutting Calculation : P 367 / Schnittberechnung : 367

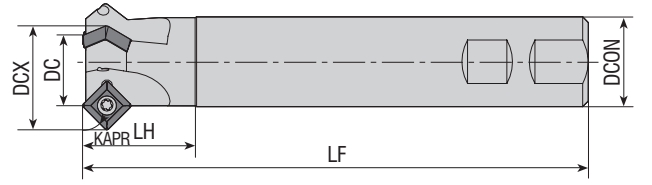

Takım Kodu Ordering Code Bestell-Bezeichnung	Stok Stock Lager	Takım Ölçüleri (mm) Dimension (mm) Abmessung (mm)								Kesici Uç Insert Wendeschneidplatte	Yedek Parçaları / Spare Parts / Ersatzteile	
		KAPR	DC	DCX	DCON	LF	LH	ZEFP	a		Sıkma Vidası Screw Schraube	Tork Anahtar Torx Key Torx-Schlüssel
ACM45-SP1104-D12x26-W20-L150-Z01	●	45°	12	26	20	150	30	1	-	SPGT 110408	4015-M4x9	80-T15
ACM45-SP1104-D25x39-W25-L150-Z02	●	45°	25	39	25	150	35	2	-			
ACM45-SP1104-D32x46-W32-L150-Z03	●	45°	32	46	32	150	40	3	-			

ZCC Ucuna Uygun. / Compatible with ZCC Insert. Kompatibel mit ZCC Wendeplatten.

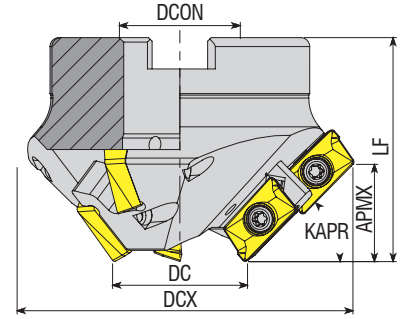

Takım Kodu Ordering Code Bestell-Bezeichnung	Stok Stock Lager	Takım Ölçüleri (mm) Dimension (mm) Abmessung (mm)								Kesici Uç Insert Wendeschneidplatte	Yedek Parçaları / Spare Parts / Ersatzteile	
		ZEFP		KAPR	DC	DCX	DCON	APMX	LF		Sıkma Vidası Screw Schraube	Tork Anahtar Torx Key Torx-Schlüssel
		Toplam Total Gesamt	Etkili Effective Effektiv									
AHM15-AP16-D35x93-A27-Z0306-H	●	6	3	15	35	93	27	8	50	AP. 1604..	4015-M4x11	80-T15
AHM30-AP16-D35x87-A27-Z0306-H	●	6	3	30	35	87	27	15	50			
AHM45-AP16-D35x77-A27-Z0306-H	●	6	3	45	35	77	27	21.5	50			
AHM60-AP16-D35x65-A22-Z0306-H	●	6	3	60	35	65	22	26.5	50			
AHM75-AP16-D35x50-A22-Z0306-H	●	6	3	75	35	50	22	29.5	50			

R: Sağ / Right / Rechts L: Sol/Left/Links

● Stokta / In Stock / Auf Lager ○ Stokta Yok / Non Stock Item / Kein Lagerartikel, Lieferzeit auf Anfrage

ISO Ucuna Uygun. / Compatible with ISO Insert. Kompatibel mit ISO Wendeplatten.

Sipariş Örneği/Ordering Example/Bestellbeispiel

1 ad./pcs./stück ACM45-SP1104-D12x26-W20-L150-Z01

Kesme Hesabı : S 367 / Cutting Calculation : P 367 / Schnittberechnung : 367



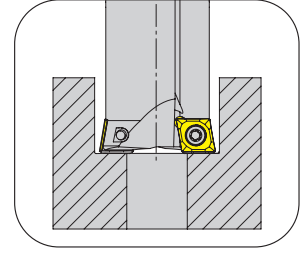
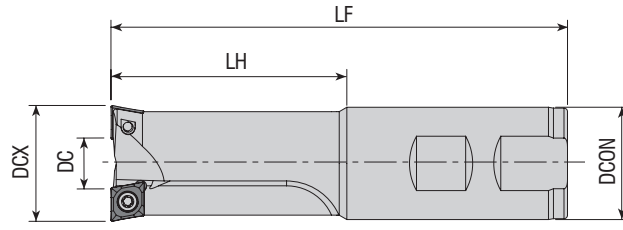

**Takım Kodu**  
**Ordering Code**  
**Bestell-Bezeichnung**

Stok  
Stock  
Lager

Takım Ölçüleri (mm)  
Dimension (mm)  
Abmessung (mm)

Kesici Uç  
Insert  
Wendeschneidplatte

Yedek Parçaları / Spare Parts / Ersatzteile

Sıkma Vidası  
Screw  
Schraube

Tork Anahtar  
Torx Key  
Torx-Schlüssel

DC DCX DCON LH LF

Kullanılan Vidalar  
For Screws  
Für Schraube



ACBM-CC06-D17X6-W16-L150-Z02	●	6	17	16	30	150	-
ACBM-CC06-D18X7-W16-L100-Z02-H	●	7	18	16	32	100	M10
ACBM-CC06-D18X7-W16-L160-Z02-H	●	7	18	16	32	160	M10
ACBM-CC06-D20X9-W20-L100-Z02-H	●	9	20	20	40	100	M12
ACBM-CC06-D20X9-W20-L160-Z02-H	●	9	20	20	38	160	M12
ACBM-CC09-D26X8.5-W25-L130-Z02-H	●	8.5	26	25	50	130	M16
ACBM-CC09-D26X8.5-W25-L200-Z02-H	●	8.5	26	25	50	200	M16
ACBM-CC09-D30X12.5-W32-L130-Z02-H	●	12.5	30	32	65	130	-
ACBM-CC09-D33X15.5-W32-L130-Z02-H	●	15.5	33	32	65	130	M20
ACBM-CC09-D33X15.5-W32-L200-Z02-H	●	15.5	33	32	65	200	M20
ACBM-SP06-D15X4-W16-L160-Z02-H	●	4	15	16	80	160	M8

CC.. 060204

3008-M2.5x6

80-T08

CC.. 09T304

4015-M3.5x9

80-T15

SP. 060204

3007-M2.2x5

80-T07

R: Sağ / Right / Rechts L: Sol/Left/Links

● Stokta / In Stock / Auf Lager ○ Stokta Yok / Non Stock Item / Kein Lagerartikel, Lieferzeit auf Anfrage  
ISO Ucuna Uygundur. / Compatible with ISO Insert. Kompatibel mit ISO Wendepplatten.

Sipariş Örneği/Ordering Example/Bestellbeispiel

1 ad./pcs./stück ACBM-CC06-D17X6-W16-L150-Z02

Kesme Hesabı : S 367 / Cutting Calculation : P 367 / Schnittberechnung : 367



KAPR=90°

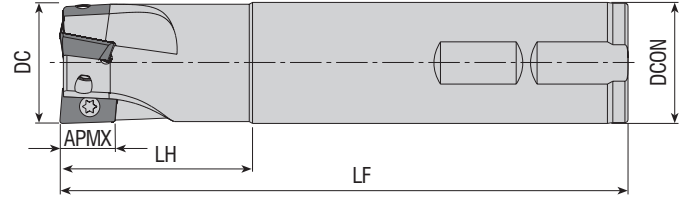

Takım Kodu Ordering Code Bestell-Bezeichnung	Stok Stock Lager	Takım Ölçüleri (mm) Dimension (mm) Abmessung (mm)						Kesici Uç Insert Wendeschneidplatte	Yedek Parçaları / Spare Parts / Ersatzteile		
		DC	ZEPF	DCON	LF	LH	APMX		Sıkma Vidası Screw Schraube	Tork Anahtar Torx Key Torx-Schlüssel	
AEM90-AD1505-D25-W25-L150-Z02	●	25	2	25	150	50	14.30	AD.. 1505..	4015-M4x9	80-T15	
AEM90-AD1505-D30-W25-L150-Z03	●	30	3	25	150	40	14.30				
AEM90-AD1505-D32-W32-L150-Z03	●	32	3	32	150	50	14.30				

ISCR Ucuna Uygun. / Compatible with ISCR Insert. Kompatibel mit ISCR Wendeplatten.

KAPR=90°

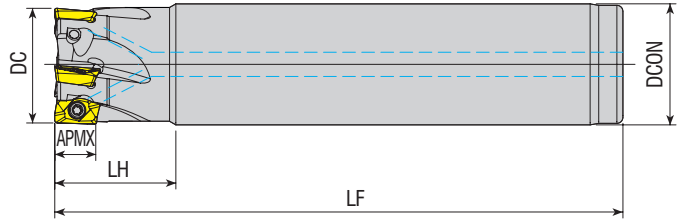

Takım Kodu Ordering Code Bestell-Bezeichnung	Stok Stock Lager	Takım Ölçüleri (mm) Dimension (mm) Abmessung (mm)						Kesici Uç Insert Wendeschneidplatte	Yedek Parçaları / Spare Parts / Ersatzteile		
		DC	ZEPF	DCON	LF	LH	APMX		Sıkma Vidası Screw Schraube	Tork Anahtar Torx Key Torx-Schlüssel	
AEM90-AD07-D10-C08-L90-Z02-H	●	10	2	8	90	16	6	ADMX 0702..	3006-M2x3.3	80-T06	
AEM90-AD07-D10-C10-L80-Z02-H	●	10	2	10	80	16	6		3006-M2x3.1		
AEM90-AD07-D12-C10-L80-Z03-H	●	12	3	10	80	18	6		3006-M2x3.3		
AEM90-AD07-D12-C12-L90-Z03-H	●	12	3	12	90	18	6		3006-M2x3.6		
AEM90-AD07-D16-C16-L110-Z04-H	●	16	4	16	110	19	6		3006-M2x4		
AEM90-AD07-D20-C20-L125-Z05-H	●	20	5	20	125	20	6				
AEM90-AD07-D25-C25-L140-Z06-H	●	25	6	25	140	24	6				
AEM90-AD11-D16-C16-L135-Z02-H	●	16	2	16	135	24	9	ADMX 11T30..	3008-M2.5x5.5	80-T08	
AEM90-AD11-D18-C16-L135-Z02-H	●	18	2	16	135	15	9				
AEM90-AD11-D18-C16-L160-Z02-H	●	18	2	16	160	15	9				
AEM90-AD11-D20-C20-L150-Z02-H	●	20	2	20	150	50	9				
AEM90-AD11-D20-C20-L150-Z03-H	●	20	3	20	150	50	9				
AEM90-AD11-D22-C20-L150-Z03-H	●	22	3	20	150	15	9				
AEM90-AD11-D22-C20-L200-Z03-H	●	22	3	20	200	15	9		3008-M2.5x6		
AEM90-AD11-D25-C25-L170-Z03-H	●	25	3	25	170	50	9				
AEM90-AD11-D25-C25-L170-Z04-H	●	25	4	25	170	50	9				
AEM90-AD11-D28-C25-L165-Z04-H	●	28	4	25	165	17	9				
AEM90-AD11-D28-C25-L200-Z04-H	●	28	4	25	200	17	9				
AEM90-AD11-D30-C25-L165-Z04-H	●	30	4	25	165	19	9				
AEM90-AD11-D30-C25-L200-Z04-H	●	30	4	25	200	19	9				
AEM90-AD11-D32-C32-L195-Z05-H	●	32	5	32	195	50	9				

R: Sağ / Right / Rechts L: Sol/Left/Links

● Stokta / In Stock / Auf Lager ○ Stokta Yok / Non Stock Item / Kein Lagerartikel, Lieferzeit auf Anfrage

PRMT Ucuna Uygun. / Compatible with PRMT Insert. Kompatibel mit PRMT Wendeplatten.

Sipariş Örneği/Ordering Example/Bestellbeispiel

1 ad./pcs./stück AEM90-AD1505-D25-W25-L150-Z02

Kesme Hesabı : S 367 / Cutting Calculation : P 367 / Schnittberechnung : 367

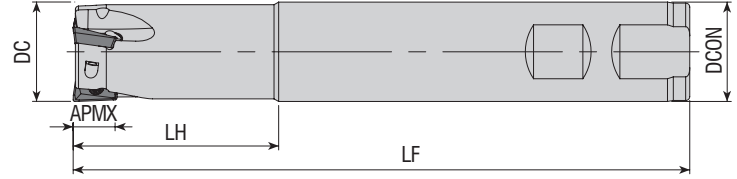

Takım Kodu Ordering Code Bestell-Bezeichnung	Stok Stock Lager	Takım Ölçüleri (mm) Dimension (mm) Abmessung (mm)						Kesici Uç Insert Wendeschneidplatte	Yedek Parçaları / Spare Parts / Ersatzteile	
		DC	ZEFP	DCON	LF	LH	APMX		Sıkma Vidası Screw Schraube	Tork Anahtar Torx Key Torx-Schlüssel
AEM90-AD0803-D16-W16-L150-Z02	●	16	2	16	150	30	8	ADMT 0803..	3008-M2.5x5	
AEM90-AD0803-D17-W16-L150-Z02	●	17	2	16	150	30	8			
AEM90-AD0803-D17-W16-L200-Z02	●	17	2	16	200	30	8			
AEM90-AD0803-D20-W20-L150-Z03	●	20	3	20	150	30	8			
AEM90-AD0803-D21-W20-L200-Z03	●	21	3	20	200	30	8			
AEM90-AD10T3-D16-W16-L100-Z02-H	●	16	2	16	100	30	10	ADMT 10T3..	3008-M2.5x6	80-T08
AEM90-AD10T3-D16-W16-L150-Z02	●	16	2	16	150	40	10			
AEM90-AD10T3-D16-C16-L200-Z02	●	16	2	16	200	50	10			
AEM90-AD10T3-D17-W16-L150-Z02	●	17	2	16	150	30	10			
AEM90-AD10T3-D17-W16-L200-Z02	●	17	2	16	200	30	10			
AEM90-AD10T3-D20-W20-L70-Z03	●	20	3	20	70	30	10			
AEM90-AD10T3-D20-W20-L100-Z03-H	●	20	3	20	100	30	10			
AEM90-AD10T3-D20-W20-L150-Z03	●	20	3	20	150	40	10			
AEM90-AD10T3-D20-C20-L150-Z03	●	20	3	20	150	40	10			
AEM90-AD10T3-D20-C20-L200-Z03	●	20	3	20	200	50	10			
AEM90-AD10T3-D25-W25-L100-Z03-H	●	25	3	25	100	30	10	ADMT 1204..	4010-M3x6	80-T10
AEM90-AD10T3-D25-W25-L100-Z04-H	●	25	4	25	100	30	10			
AEM90-AD10T3-D25-W25-L150-Z03	●	25	3	25	150	50	10			
AEM90-AD1204-D20-W20-L150-Z02	●	20	2	20	150	50	12			
AEM90-AD1204-D21-C20-L150-Z02	●	21	2	20	150	30	12			
AEM90-AD1204-D22-C20-L150-Z02	●	22	2	20	150	30	12	ADMT 1606..	4015-M4x9	80-T15
AEM90-AD1204-D25-W25-L150-Z03	●	25	3	25	150	50	12			
AEM90-AD1204-D26-W25-L180-Z03	●	26	3	25	180	30	12			
AEM90-AD1204-D32-W32-L150-Z04	●	32	4	32	150	50	12	ADMT 1606..	4015-M4x9	80-T15
AEM90-AD1606-D25-W25-L150-Z02	●	25	2	25	150	50	15			
AEM90-AD1606-D32-W32-L150-Z03	●	32	3	32	150	50	15			

R: Sağ / Right / Rechts L: Sol/Left/Links

● Stokta / In Stock / Auf Lager ○ Stokta Yok / Non Stock Item / Kein Lagerartikel, Lieferzeit auf Anfrage  
WLTR Ucuna Uygunudur. / Compatible with WLTR Insert. Kompatibel mit WLTR Wendepplatten.

Sipariş Örneği/Ordering Example/Bestellbeispiel  
1 ad./pcs./stück AEM90-AD0803-D16-W16-L150-Z02  
Kesme Hesabı : S 367 / Cutting Calculation : P 367 / Schnittberechnung : 367

KAPR=90°

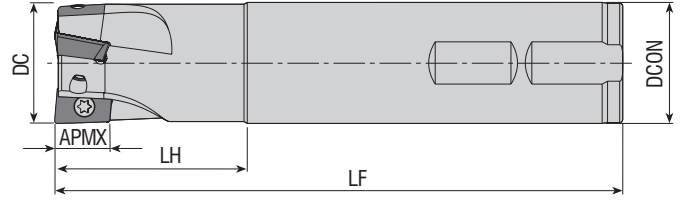

Takım Kodu Ordering Code Bestell-Bezeichnung	Stok Stock Lager	Takım Ölçüleri (mm) Dimension (mm) Abmessung (mm)						Kesici Uç Insert Wendeschneidplatte	Yedek Parçaları / Spare Parts / Ersatzteile	
		DC	ZEPF	DCON	LF	LH	APMX		Sıkma Vidası Screw Schraube	Tork Anahtar Torx Key Torx-Schlüssel
AEM90-AD1003-D16-C16-L150-Z02	●	16	2	16	150	30	8	ADMT 1003..	3008-M2.5x5	80-T08
AEM90-AD1003-D17-C16-L150-Z02	●	17	2	16	150	25	8			
AEM90-AD1003-D20-C20-L200-Z03	●	20	3	20	200	50	8			
AEM90-AD1003-D21-C20-L150-Z03	●	21	3	20	150	25	8			
AEM90-AD1003-D21-C20-L200-Z03	●	21	3	20	200	25	8			
AEM90-AD1003-D25-C25-L200-Z03	●	25	3	25	200	50	8			
AEM90-AD1003-D26-C25-L150-Z03	●	26	3	25	150	30	8			
AEM90-AD1003-D26-C25-L200-Z03	●	26	3	25	200	30	8			
AEM90-AD1505D-D25-W25-L150-Z02	●	25	2	25	150	50	14.3	ADKT 1505..	4015-M4x9	80-T15
AEM90-AD1505D-D32-W32-L150-Z03	●	32	3	32	150	50	14.3		4015-M4x11	

DJT Ucuna Uygun. / Compatible with DJT Insert. Kompatibel mit DJT Wendeplatten.

KAPR=90°

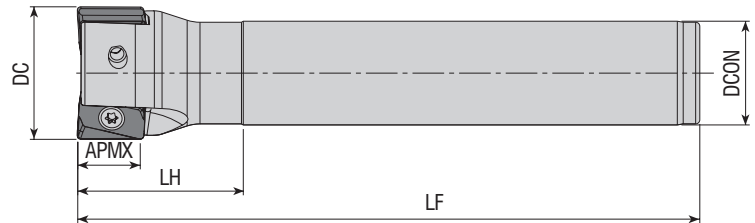

Takım Kodu Ordering Code Bestell-Bezeichnung	Stok Stock Lager	Takım Ölçüleri (mm) Dimension (mm) Abmessung (mm)						Kesici Uç Insert Wendeschneidplatte	Yedek Parçaları / Spare Parts / Ersatzteile	
		DC	ZEPF	DCON	LF	LH	APMX		Sıkma Vidası Screw Schraube	Tork Anahtar Torx Key Torx-Schlüssel
AEM90-AN11-D22-W20-L150-Z02	●	22	2	20	150	30	11	ANGX 1105..	4010-M3x8	80-T10
AEM90-AN11-D25-W25-L150-Z02	●	25	2	25	150	40	11			
AEM90-AN11-D25-C25-L200-Z02	●	25	2	25	200	40	11			
AEM90-AN11-D26-W25-L150-Z02	●	26	2	25	150	40	11			
AEM90-AN11-D28-W25-L150-Z02	●	28	2	25	150	25	11			
AEM90-AN11-D32-W32-L150-Z03	●	32	3	32	150	50	11			
AEM90-AN11-D32-C32-L200-Z03	●	32	3	32	200	50	11			
AEM90-AN11-D40-W32-L150-Z04	●	40	4	32	150	40	11			

R: Sağ / Right / Rechts L: Sol/Left/Links

● Stokta / In Stock / Auf Lager ○ Stokta Yok / Non Stock Item / Kein Lagerartikel, Lieferzeit auf Anfrage  
ZCC Ucuna Uygun. / Compatible with ZCC Insert. Kompatibel mit ZCC Wendeplatten.

Sipariş Örneği/Ordering Example/Bestellbeispiel

1 ad./pcs./stück AEM90-AD1003-D16-C16-L150-Z02

Kesme Hesabı : S 367 / Cutting Calculation : P 367 / Schnittberechnung : 367



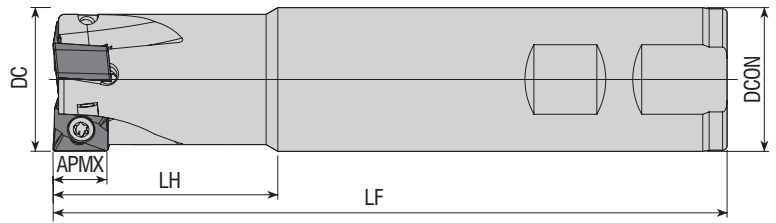

Takım Kodu Ordering Code Bestell-Bezeichnung	Stok Stock Lager	Takım Ölçüleri (mm) Dimension (mm) Abmessung (mm)						Kesici Uç Insert Wendeschneidplatte	Yedek Parçaları / Spare Parts / Ersatzteile	
		DC	ZEFP	DCON	LF	LH	APMX		Sıkma Vidası Screw Schraube	Tork Anahtar Torx Key Torx-Schlüssel
AEM90-AN1207-D25-W25-L150-Z02	●	25	2	25	150	40	10	ANKX 1207..	4015-M4x11	80-T15
AEM90-AN1207-D32-W32-L150-Z03	●	32	3	32	150	50	10			
AEM90-AN1207-D40-W32-L150-Z04	●	40	4	32	150	40	10			

XTC-GSC Ucuna Uygunudur. / Compatible with XTC-GSC Insert. Kompatibel mit XTC-GSC Wendeplatten.

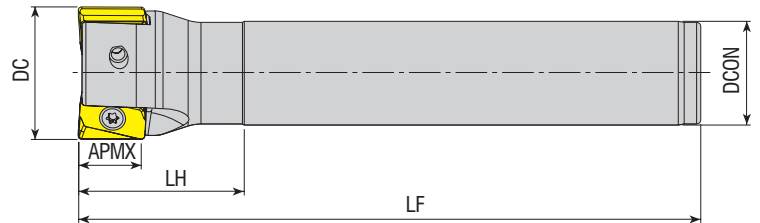

Takım Kodu Ordering Code Bestell-Bezeichnung	Stok Stock Lager	Takım Ölçüleri (mm) Dimension (mm) Abmessung (mm)						Kesici Uç Insert Wendeschneidplatte	Yedek Parçaları / Spare Parts / Ersatzteile	
		DC	ZEFP	DCON	LF	LH	APMX		Sıkma Vidası Screw Schraube	Tork Anahtar Torx Key Torx-Schlüssel
AEM90-AN1607-D32-C25-L150-Z02	●	32	2	25	150	50	15	AN.X 1607..	4015-M4x11	80-T15
AEM90-AN1607-D40-C32-L150-Z03	●	40	3	32	150	50	15			

R: Sağ / Right / Rechts L: Sol/Left/Links

● Stokta / In Stock / Auf Lager ○ Stokta Yok / Non Stock Item / Kein Lagerartikel, Lieferzeit auf Anfrage  
TGTC Ucuna Uygunudur. / Compatible with TGTC Insert. Kompatibel mit TGTC Wendeplatten.

Sipariş Örneği/Ordering Example/Bestellbeispiel  
1 ad./pcs./stück AEM90-AN1207-D25-W25-L150-Z02  
Kesme Hesabı : S 367 / Cutting Calculation : P 367 / Schnittberechnung : 367

KAPR=90°

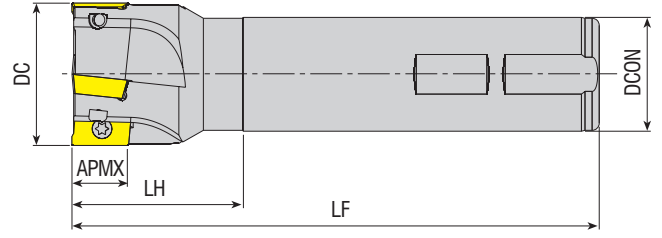

Takım Kodu Ordering Code Bestell-Bezeichnung	Stok Stock Lager	Takım Ölçüleri (mm) Dimension (mm) Abmessung (mm)						Kesici Uç Insert Wendeschneidplatte	Yedek Parçaları / Spare Parts / Ersatzteile	
		DC	ZEP	DCON	LF	LH	APMX		Sıkma Vidası Screw Schraube	Tork Anahtar Torx Key Torx-Schlüssel
AEM90-AP06-D10-C10-L120-Z02	●	10	2	10	120	20	5.6	APMT 0602.. KRLY UCUNA UYGUNDUR. FOR KRLY INSERT. Für KRLY	3006-M1.8x4	80-T06
AEM90-AP06-D12-C12-L120-Z02	●	12	2	12	120	20	5.6			
AEM90-AP0903-D12-C16-L080-Z01-H	●	12	1	16	80	30	9	APMT 0903..  KRLY UCUNA UYGUNDUR. FOR KRLY INSERT. Kompatibel mit Wendeschneidplatte KRLY	3008-M2.5x5	
AEM90-AP0903-D16-C16-L090-Z02	●	16	2	16	90	30	9			
AEM90-AP0903-D16-C16-L150-Z02	●	16	2	16	150	30	9			
AEM90-AP0903-D17-C16-L150-Z02	●	17	2	16	150	30	9			
AEM90-AP0903-D18-C16-L090-Z02-H	●	18	2	16	90	30	9			
AEM90-AP0903-D20-C20-L110-Z03	●	20	3	20	110	30	9			
AEM90-AP0903-D20-C20-L150-Z02	●	20	2	20	150	30	9			
AEM90-AP0903-D20-C20-L200-Z02	●	20	2	20	200	100	9			
AEM90-AP0903-D21-C20-L150-Z02	●	21	2	20	150	30	9			
AEM90-AP0903-D25-C25-L120-Z03	●	25	3	25	120	30	9			
AEM90-AP0903-D25-C25-L150-Z03	●	25	3	25	150	30	9			
AEM90-AP0903-D25-C25-L200-Z02	●	25	2	25	200	100	9			
AEM90-AP09-D16-C16-L100-Z02-H	●	16	2	16	100	30	8.8	APKT 09T3..  TGTC UCUNA UYGUNDUR. FOR TGTC INSERT. Kompatibel mit Wendeschneidplatte TGTC	3008-M2.5x5	80-T08
AEM90-AP09-D16-C15-L150-Z02	●	16	2	15	150	25	8.8			
AEM90-AP09-D16-W16-L150-Z02-H	●	16	2	16	150	25	8.8			
AEM90-AP09-D16-C16-L200-Z02-H	●	16	2	16	200	100	8.8			
AEM90-AP09-D17-C16-L150-Z02	●	17	2	16	150	25	8.8			
AEM90-AP09-D17-C16-L180-Z02-H	●	17	2	16	180	25	8.8			
AEM90-AP09-D20-C20-L150-Z03-H	●	20	3	20	150	50	8.8			
AEM90-AP09-D20-C20-L200-Z03-H	●	20	3	20	200	100	8.8			
AEM90-AP09-D20-C20-L250-Z02-H	●	20	2	20	250	150	8.8			
AEM90-AP09-D21-C20-L150-Z03	●	21	3	20	150	25	8.8			
AEM90-AP09-D26-C25-L150-Z04	●	26	4	25	150	30	8.8			
AEM90-AP10-D10-C10-L100-Z01	●	10	1	10	100	20	10	AP. 1003..  ISO UCUNA UYGUNDUR. FOR ISO INSERT. Kompatibel mit Wendeschneidplatte ISO	3008-M2.5x5	
AEM90-AP10-D12-C16-L100-Z01-H	●	12	1	16	100	30	10			
AEM90-AP10-D12-W16-L100-Z01-H	●	12	1	16	100	30	10			
AEM90-AP10-D12-W16-L150-Z01	●	12	1	16	150	38	10			
AEM90-AP10-D14-W16-L100-Z01-H	●	14	1	16	100	30	10			
AEM90-AP10-D14-W16-L150-Z01	●	14	1	16	150	38	10			
AEM90-AP10-D16-C16-L100-Z02-H	●	16	2	16	100	30	10			
AEM90-AP10-D16-W16-L100-Z02-H	●	16	2	16	100	30	10			
AEM90-AP10-D16-W16-L200-Z02	●	16	2	16	200	100	10			
AEM90-AP10-D16-C16-L120-Z02-H	●	16	2	16	120	30	10			

R: Sağ / Right / Rechts L: Sol/Left/Links

● Stokta / In Stock / Auf Lager ○ Stokta Yok / Non Stock Item / Kein Lagerartikel, Lieferzeit auf Anfrage



Sipariş Örneği/Ordering Example/Bestellbeispiel

1 ad./pcs./stück AEM90-AP06-D10-C10-L120-Z02

Kesme Hesabı : S 367 / Cutting Calculation : P 367 / Schnittberechnung : 367

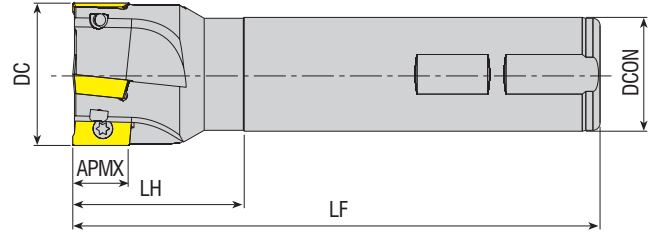
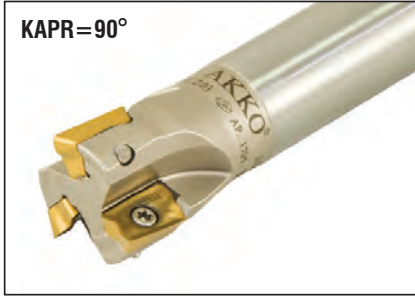



Takım Kodu Ordering Code Bestell-Bezeichnung	Stok Stock Lager	Takım Ölçüleri (mm) Dimension (mm) Abmessung (mm)						Kesici Uç Insert Wendeschneidplatte	Yedek Parçaları / Spare Parts / Ersatzteile		
		DC	ZEFP	DCON	LF	LH	APMX		Sıkma Vidası Screw Schraube	Tork Anahtar Torx Key Torx-Schlüssel	
AEM90-AP10-D16-C16-L150-Z02	●	16	2	16	150	50	10	  <b>AP. 1003..</b> <b>ISO UCUNA</b> <b>UYGUNDUR.</b> <b>FOR ISO INSERT.</b> <i>Kompatibel mit Wendeschneidplatte ISO</i>	  3008-M2.5x5	  80-T08	
AEM90-AP10-D16-C16-L150-Z02-H	●	16	2	16	150	50	10				
AEM90-AP10-D16-W16-L150-Z02	●	16	2	16	150	50	10				
AEM90-AP10-D16-C16-L200-Z02	●	16	2	16	200	100	10				
AEM90-AP10-D16-C16-L200-Z02-H	●	16	2	16	200	100	10				
AEM90-AP10-D16-C16-L250-Z02	●	16	2	16	250	150	10				
AEM90-AP10-D18-W16-L100-Z02-H	●	18	2	16	100	30	10				
AEM90-AP10-D18-W16-L150-Z02	●	18	2	16	150	30	10				
AEM90-AP10-D20-C20-L100-Z03-H	●	20	3	20	100	30	10				
AEM90-AP10-D20-W20-L100-Z03-H	●	20	3	20	100	30	10				
AEM90-AP10-D20-C20-L120-Z03-H	●	20	3	20	120	30	10				
AEM90-AP10-D20-C20-L150-Z03	●	20	3	20	150	50	10				
AEM90-AP10-D20-C20-L150-Z03-H	●	20	3	20	150	50	10				
AEM90-AP10-D20-W20-L150-Z03	●	20	3	20	150	50	10				
AEM90-AP10-D20-C20-L200-Z02	●	20	2	20	200	100	10				
AEM90-AP10-D20-C20-L200-Z03-H	●	20	3	20	200	100	10				
AEM90-AP10-D20-C20-L250-Z02	●	20	2	20	250	150	10				
AEM90-AP10-D20-C20-L250-Z02-H	●	20	2	20	250	150	10				
AEM90-AP10-D21-C20-L200-Z03	●	21	3	20	200	30	10				
AEM90-AP10-D21-W20-L150-Z03	●	21	3	20	150	30	10				
AEM90-AP10-D22-W20-L100-Z03-H	●	22	3	20	100	30	10				
AEM90-AP10-D22-W20-L150-Z03	●	22	3	20	150	30	10				
AEM90-AP10-D23-W20-L150-Z03	●	23	3	20	150	30	10				
AEM90-AP10-D24-W20-L150-Z03	●	24	3	20	150	30	10				
AEM90-AP10-D25-W25-L100-Z04-H	●	25	4	25	100	30	10				
AEM90-AP10-D25-C25-L100-Z03-H	●	25	3	25	100	30	10				
AEM90-AP10-D25-W25-L100-Z03-H	●	25	3	25	100	30	10				
AEM90-AP10-D25-C25-L120-Z03-H	●	25	3	25	120	30	10				
AEM90-AP10-D25-C25-L150-Z03	●	25	3	25	150	50	10				
AEM90-AP10-D25-W25-L150-Z03	●	25	3	25	150	50	10				
AEM90-AP10-D25-C25-L200-Z02	●	25	2	25	200	100	10				
AEM90-AP10-D25-C25-L200-Z03	●	25	3	25	200	100	10				
AEM90-AP10-D25-C25-L250-Z02	●	25	2	25	250	100	10				

R: Sağ / Right / Rechts L: Sol/Left/Links

● Stokta / In Stock / Auf Lager ○ Stokta Yok / Non Stock Item / Kein Lagerartikel, Lieferzeit auf Anfrage









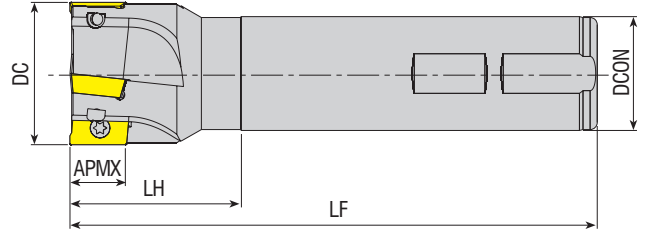
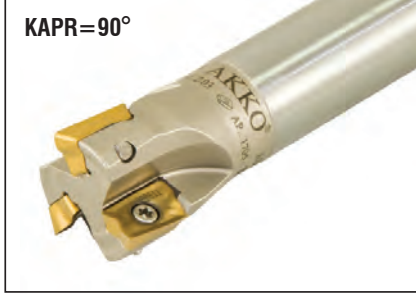





Sipariş Örneği/Ordering Example/Bestellbeispiel

1 ad./pcs./stück AEM90-AP10-D16-C16-L150-Z02

Kesme Hesabı : S 367 / Cutting Calculation : P 367 / Schnittberechnung : 367

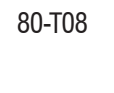
KAPR=90°



Takım Kodu Ordering Code Bestell-Bezeichnung	Stok Stock Lager	Takım Ölçüleri (mm) Dimension (mm) Abmessung (mm)						Kesici Uç Insert Wendeschneidplatte	Yedek Parçaları / Spare Parts / Ersatzteile		
		DC	ZEPF	DCON	LF	LH	APMX		Sıkma Vidası Screw Schraube	Tork Anahtar Torx Key Torx-Schlüssel	
AEM90-AP10-D30-C25-L100-Z04-H	●	30	4	25	100	30	10	 <b>AP. 1003..</b> ISO UCUNA UYGUNDUR. FOR ISO INSERT. Kompatibel mit Wendeschneidplatte ISO	 3008-M2.5x6	 80-T08	
AEM90-AP10-D30-C25-L120-Z04-H	●	30	4	25	120	30	10				
AEM90-AP10-D30-C25-L150-Z04	●	30	4	25	150	30	10				
AEM90-AP10-D32-C25-L100-Z04-H	●	32	4	25	100	35	10				
AEM90-AP10-D32-C25-L120-Z04-H	●	32	4	25	120	35	10				
AEM90-AP10-D32-C25-L150-Z04	●	32	4	25	150	35	10				
AEM90-AP10-D32-W25-L150-Z04	●	32	4	25	150	35	10				
AEM90-AP10-D32-C32-L130-Z05	●	32	5	32	130	30	10				
AEM90-AP10-D32-W32-L150-Z04	●	32	4	32	150	50	10				
AEM90-AP10-D40-W32-L150-Z05	●	40	5	32	150	40	10				
AEM90-AP10D-D16-W16-L150-Z02	●	16	2	16	150	50	10	 <b>AP. 1003..</b> DJT UCUNA UYGUNDUR. FOR DJT INSERT Für DJT	 3008-M2.5x5	 80-T08	
AEM90-AP10D-D20-W20-L150-Z03	●	20	3	20	150	50	10				
AEM90-AP10D-D25-W20-L150-Z03	●	25	3	20	150	30	10				
AEM90-AP100-D16-C15-L150-Z02	●	16	2	15	150	30	10	 <b>AP. 1003..</b> B.OKE UCUNA UYGUNDUR. FOR B.OKE INSERT Kompatibel mit Wendeschneidplatte B.OKE	 3008-M2.5x5	 80-T08	
AEM90-AP100-D21-C20-L150-Z03	●	21	3	20	150	30	10				
AEM90-AP100-D26-C25-L150-Z04	●	26	4	25	150	35	10				
AEM90-AP100-D33-C32-L200-Z05	●	33	5	32	200	50	10				
AEM90-AP10S-D16-W16-L150-Z02	●	16	2	16	150	26	10	 <b>AP. 1003..</b> SMTM UCUNA UYGUNDUR. FOR SMTM INSERT Kompatibel mit Wendeschneidplatte SMTM	 3008-M2.5x6	 80-T08	
AEM90-AP10S-D20-W20-L150-Z02	●	20	2	20	150	26	10				
AEM90-AP10S-D25-W25-L150-Z03	●	25	3	25	150	26	10				
AEM90-AP11-D16-C16-L150-Z02	●	16	2	16	150	50	11	 <b>AP. 11T3..</b> ZCC UCUNA UYGUNDUR. FOR ZCC INSERT. Kompatibel mit Wendeschneidplatte ZCC	 3008-M2.5x6	 80-T08	
AEM90-AP11-D16-C16-L150-Z02-H	●	16	2	16	150	50	11				
AEM90-AP11-D16-W16-L150-Z02	●	16	2	16	150	50	11				
AEM90-AP11-D16-W16-L150-Z02-H	●	16	2	16	150	50	11				
AEM90-AP11-D16-C16-L200-Z02	●	16	2	16	200	100	11				
AEM90-AP11-D17-C16-L150-Z02	●	17	2	16	150	30	11				
AEM90-AP11-D17-C16-L200-Z02	●	17	2	16	200	30	11				
AEM90-AP11-D20-C20-L150-Z03	●	20	3	20	150	50	11				
AEM90-AP11-D20-W20-L150-Z03	●	20	3	20	150	50	11				
AEM90-AP11-D20-W20-L150-Z03-H	●	20	3	20	150	50	11				
AEM90-AP11-D20-C20-L200-Z03	●	20	3	20	200	100	11				
AEM90-AP11-D21-C20-L150-Z03	●	21	3	20	150	30	11				
AEM90-AP11-D21-W20-L150-Z03	●	21	3	20	150	30	11				
AEM90-AP11-D21-W20-L150-Z03-H	●	21	3	20	150	30	11				
AEM90-AP11-D21-C20-L200-Z03	●	21	3	20	200	30	11				
AEM90-AP11-D25-C25-L150-Z03	●	25	3	25	150	50	11				
AEM90-AP11-D25-W25-L150-Z03	●	25	3	25	150	50	11				
AEM90-AP11-D25-W25-L150-Z03-H	●	25	3	25	150	50	11				
AEM90-AP11-D26-C25-L150-Z03	●	26	3	25	150	35	11				
AEM90-AP11-D26-C24-L150-Z03	●	26	3	24	150	35	11				
AEM90-AP11-D32-W25-L150-Z04	●	32	4	25	150	35	11				
AEM90-AP11-D32-W32-L150-Z03-H	●	32	3	32	150	50	11				
AEM90-AP11-D32-W32-L150-Z04	●	32	4	32	150	50	11				

R: Sağ / Right / Rechts L: Sol/Left/Links / ● Stokta / In Stock / Auf Lager ○ Stokta Yok / Non Stock Item / Kein Lagerartikel, Lieferzeit auf Anfrage

Sipariş Örneği/Ordering Example/Bestellbeispiel

1 ad./pcs./stück AEM90-AP10-D30-C25-L100-Z04-H

Kesme Hesabı : S 367 / Cutting Calculation : P 367 / Schnittberechnung : 367



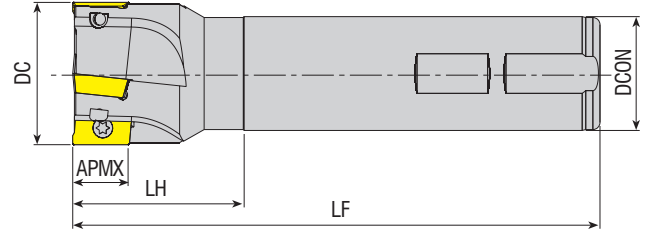
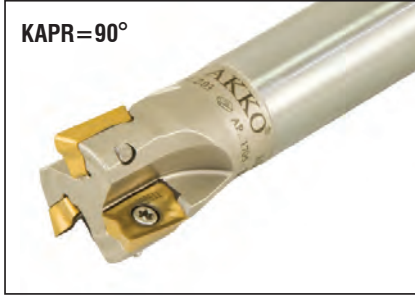

Takım Kodu Ordering Code Bestell-Bezeichnung	Stok Stock Lager	Takım Ölçüleri (mm) Dimension (mm) Abmessung (mm)						Kesici Uç Insert Wendeschneidplatte	Yedek Parçaları / Spare Parts / Ersatzteile	
		DC	ZEPF	DCON	LF	LH	APMX		Sıkma Vidası Screw Schraube	Tork Anahtar Torx Key Torx-Schlüssel
AEM90-AP1135A-D14-C16-L150-Z01	●	14	1	16	150	40	9.5	<b>APMT 1135..</b> <b>ACHTK UCUNA UYGUNDUR.</b> <b>FOR ACHTK INSERT.</b> <i>Kompatibel mit Wendeschneidplatte ACHTK</i>	3008-M2.5x5	80-T08
AEM90-AP1135A-D16-C16-L150-Z02	●	16	2	16	150	40	9.5			
AEM90-AP1135A-D16-C16-L200-Z02	●	16	2	16	200	100	9.5			
AEM90-AP1135A-D16-C16-L250-Z02	●	16	2	16	250	150	9.5			
AEM90-AP1135A-D17-C16-L180-Z02	●	17	2	16	180	30	9.5			
AEM90-AP1135A-D20-C20-L150-Z03	●	20	3	20	150	50	9.5			
AEM90-AP1135A-D20-C20-L200-Z02	●	20	2	20	200	100	9.5		3008-M2.5x6	
AEM90-AP1135A-D21-C20-L180-Z02	●	21	2	20	180	30	9.5			
AEM90-AP1135A-D25-C25-L200-Z03	●	25	3	25	200	100	9.5			
AEM90-AP1135A-D26-C25-L250-Z02	●	26	2	25	250	35	9.5			
AEM90-AP1135A-D33-C32-L250-Z02	●	33	2	32	250	35	9.5			
AEM90-AP110-D16-C15-L150-Z02	●	16	2	15	150	30	11			
AEM90-AP110-D21-C20-L150-Z03	●	21	3	20	150	30	11			
AEM90-AP110-D26-C25-L150-Z04	●	26	4	25	150	35	11	3008-M2.5x6		
AEM90-AP110-D33-C32-L200-Z05	●	33	5	32	200	50	11			
AEM90-APK11G-D16-W16-L150-Z02	●	16	2	16	150	26	11	<b>APKT 1135..</b> <b>XTC-GSC UCUNA UYGUNDUR.</b> <b>FOR XTC-GSC INSERT</b> <i>Kompatibel mit Wendeschneidplatte XTC-GSC</i>	3008-M3x5	
AEM90-APK11G-D20-W20-L150-Z03	●	20	3	20	150	26	11			
AEM90-APK11G-D25-W25-L150-Z03	●	25	3	25	150	26	11			3008-M3x6
AEM90-AP1135-D16-W16-L110-Z02-H	●	16	2	16	110	30	9.5	<b>AP. 1135..</b> <b>XTC-GSC UCUNA UYGUNDUR.</b> <b>FOR XTC-GSC INSERT.</b> <i>Kompatibel mit Wendeschneidplatte XTC-GSC</i>		
AEM90-AP1135-D16-W16-L150-Z02	●	16	2	16	150	50	9.5			
AEM90-AP1135-D20-W20-L125-Z03-H	●	20	3	20	125	30	9.5			
AEM90-AP1135-D20-W20-L150-Z03	●	20	3	20	150	50	9.5			
AEM90-AP1135-D25-W25-L125-Z04-H	●	25	4	25	125	30	9.5			
AEM90-AP1135-D25-W25-L200-Z04-H	●	25	4	25	200	100	9.5			
AEM90-AP1135-D32-W32-L125-Z05-H	●	32	5	32	125	30	9.5			
AEM90-AP1135-D32-W32-L200-Z04-H	●	32	4	32	200	100	9.5			
AEM90-AP1135Y-D16-C16-L120-Z02-H	●	16	2	16	120	30	9.5		<b>APMT 1135..</b> <b>YG UCUNA UYGUNDUR.</b> <b>FOR YG INSERT.</b> <i>Kompatibel mit Wendeschneidplatte YG</i>	
AEM90-AP1135Y-D16-W16-L150-Z02	●	16	2	16	150	50	9.5			
AEM90-AP1135Y-D17-C16-L150-Z02	●	17	2	16	150	30	9.5			
AEM90-AP1135Y-D20-C20-L120-Z02	●	20	2	20	120	30	9.5			
AEM90-AP1135Y-D20-W20-L150-Z03	●	20	3	20	150	50	9.5			
AEM90-AP1135Y-D21-C20-L150-Z03	●	21	3	20	150	30	9.5			
AEM90-AP1135Y-D25-W25-L150-Z03	●	25	3	25	150	50	9.5			
AEM90-AP1135Y-D25-C25-L150-Z04-H	●	25	4	25	150	30	9.5			
AEM90-AP1135Y-D26-C25-L150-Z03	●	26	3	25	150	35	9.5			
AEM90-AP1135Y-D32-W25-L110-Z04	●	32	4	25	110	35	9.5			
AEM90-AP1204-D20-C20-L150-Z02	●	20	2	20	150	30	12	<b>AP. 1204..</b> <b>TGTC UCUNA UYGUNDUR.</b> <b>FOR TGTC INSERT.</b> <i>Kompatibel mit Wendeschneidplatte TGTC</i>	3010-M3.5x7	
AEM90-AP1204-D21-C20-L150-Z02	●	21	2	20	150	30	12			
AEM90-AP1204-D21-C20-L200-Z02	●	21	2	20	200	30	12		3010-M3.5x9	
AEM90-AP1204-D25-C25-L150-Z03	●	25	3	25	150	40	12			
AEM90-AP1204-D26-C25-L250-Z02	●	26	2	25	250	35	12			
AEM90-AP1204-D32-C25-L150-Z03	●	32	3	25	150	35	12			

R: Sağ / Right / Rechts L: Sol/Left/Links

● Stokta / In Stock / Auf Lager ○ Stokta Yok / Non Stock Item / Kein Lagerartikel, Lieferzeit auf Anfrage

Sipariş Örneği/Ordering Example/Bestellbeispiel

1 ad./pcs./stück AEM90-AP1135A-D14-C16-L150-Z01

Kesme Hesabı : S 367 / Cutting Calculation : P 367 / Schnittberechnung : 367



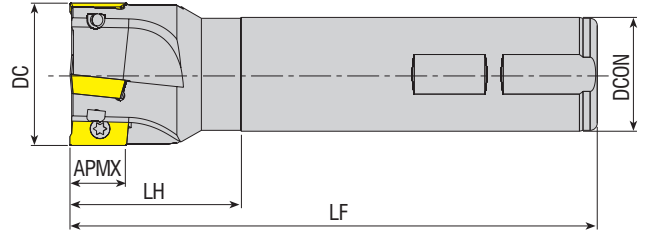
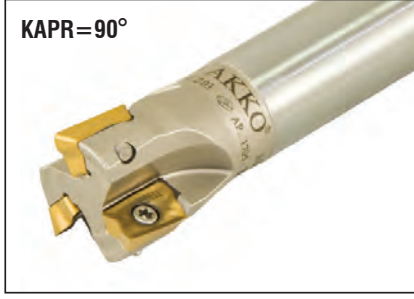



KAPR=90°



Yedek Parçaları / Spare Parts / Ersatzteile

**Takım Kodu**  
**Ordering Code**  
**Bestell-Bezeichnung**

Stok  
Stock  
LagerTakım Ölçüleri (mm)  
Dimension (mm)  
Abmessung (mm)Kesici Uç  
Insert  
WendeschneidplatteSıkma Vidası  
Screw  
SchraubeTork Anahtar  
Torx Key  
Torx-Schlüssel

	DC	ZEP	DCON	LF	LH	APMX				
AEM90-AP16-D25-C20-L100-Z02	●	25	2	20	100	35	  <b>AP. 1604..</b> <b>ISO UCUNA</b> <b>UYGUNDUR.</b> <b>FOR ISO INSERT</b> <i>Kompatibel mit Wendeschneidplatte ISO</i>	  4015-M4x9	  80-T15	
AEM90-AP16-D25-W25-L100-Z02-H	●	25	2	25	100	35				16
AEM90-AP16-D25-W25-L150-Z02	●	25	2	25	150	50				16
AEM90-AP16-D25-C25-L250-Z02	●	25	2	25	250	100				16
AEM90-AP16-D28-W25-L100-Z03-H	●	28	3	25	100	40				16
AEM90-AP16-D28-W25-L150-Z03	●	28	3	25	150	40				16
AEM90-AP16-D30-W25-L110-Z03-H	●	30	3	25	110	40				16
AEM90-AP16-D30-W25-L150-Z02	●	30	2	25	150	40				16
AEM90-AP16-D30-W25-L150-Z03	●	30	3	25	150	40				16
AEM90-AP16-D32-W32-L110-Z03-H	●	32	3	32	110	40				16
AEM90-AP16-D32-C32-L150-Z03	●	32	3	32	150	50				16
AEM90-AP16-D32-W25-L150-Z03	●	32	3	25	150	40				16
AEM90-AP16-D32-W32-L150-Z03	●	32	3	32	150	50				16
AEM90-AP16-D32-W32-L150-Z03-H	●	32	3	32	150	50				16
AEM90-AP16-D32-C25-L200-Z03-H	●	32	3	25	200	40				16
AEM90-AP16-D32-C32-L250-Z02	●	32	2	32	250	100				16
AEM90-AP16-D32-C32-L250-Z03	●	32	3	32	250	100				16
AEM90-AP16-D35-W32-L150-Z03	●	35	3	32	150	40				16
AEM90-AP16-D36-W32-L110-Z03-H	●	36	3	32	110	40				16
AEM90-AP16-D36-W32-L150-Z03	●	36	3	32	150	40				16
AEM90-AP16-D40-W32-L110-Z04-H	●	40	4	32	110	40	16			
AEM90-AP16-D40-C32-L150-Z04	●	40	4	32	150	40	16			
AEM90-AP16-D40-W32-L150-Z04	●	40	4	32	150	40	16			
AEM90-AP16-D40-C32-L250-Z02	●	40	2	32	250	40	16			
AEM90-AP16-D40-C32-L250-Z04	●	40	4	32	250	40	16			
AEM90-AP16DJ-D25-W25-L150-Z02	●	25	2	25	150	50	16	  <b>AP. 1604..</b> <b>DJT UCUNA</b> <b>UYGUNDUR.</b> <b>FOR DJT INSERT.</b> <i>Kompatibel mit Wendeschneidplatte DJT</i>	  4015-M4x9	  80-T15
AEM90-AP16DJ-D25-C25-L200-Z02	●	25	2	25	200	50	16			
AEM90-AP16DJ-D32-W32-L150-Z03	●	32	3	32	150	50	16			
AEM90-AP16DJ-D32-C32-L180-Z03	●	32	3	32	180	50	16			
AEM90-AP16DJ-D32-C32-L200-Z03	●	32	3	32	200	50	16			
AEM90-AP16L-D25-C25-L120-Z02-H	●	25	2	25	120	45	16			
AEM90-AP16L-D25-C25-L150-Z02	●	25	2	25	150	55	16			
AEM90-AP16L-D25-C25-L200-Z02	●	25	2	25	200	55	16			
AEM90-AP16L-D25-C25-L250-Z02	●	25	2	25	250	100	16			
AEM90-AP16L-D30-W25-L120-Z03-H	●	30	3	25	120	40	16			
AEM90-AP16L-D32-C32-L120-Z03-H	●	32	3	32	120	45	16			
AEM90-AP16L-D32-C32-L150-Z03	●	32	3	32	150	55	16			
AEM90-AP16L-D32-C32-L200-Z03	●	32	3	32	200	55	16			
AEM90-AP16L-D32-C32-L250-Z03	●	32	3	32	250	100	16			
AEM90-AP16L-D40-C32-L120-Z04-H	●	40	4	32	120	40	16			
AEM90-AP16L-D40-C32-L150-Z04	●	40	4	32	150	40	16			
AEM90-AP16L-D40-C32-L200-Z04	●	40	4	32	200	40	16			
AEM90-AP16L-D40-C32-L250-Z04	●	40	4	32	250	40	16			

R: Sağ / Right / Rechts L: Sol/Left/Links

● Stokta / In Stock / Auf Lager ○ Stokta Yok / Non Stock Item / Kein Lagerartikel, Lieferzeit auf Anfrage

Sipariş Örneği/Ordering Example/Bestellbeispiel

1 ad./pcs./stück AEM90-AP16-D25-C20-L100-Z02

Kesme Hesabı : S 367 / Cutting Calculation : P 367 / Schnittberechnung : 367



www.akko.com.tr

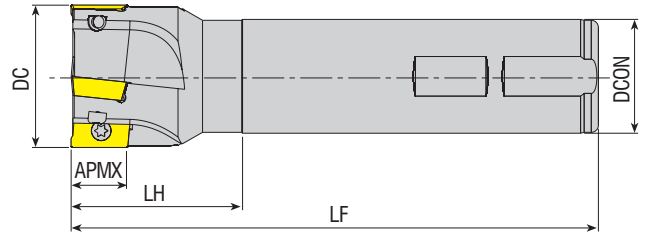
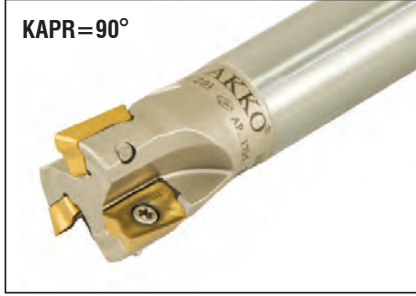

Takım Kodu Ordering Code Bestell-Bezeichnung	Stok Stock Lager	Takım Ölçüleri (mm) Dimension (mm) Abmessung (mm)						Kesici Uç Insert Wendeschneidplatte	Yedek Parçaları / Spare Parts / Ersatzteile		
		DC	ZEFP	DCON	LF	LH	APMX		Sıkma Vidası Screw Schraube	Tork Anahtar Torx Key Torx-Schlüssel	
AEM90-AP16P-D25-W25-L100-Z02-H	●	25	2	25	100	35	16	AP. 1604.. PLBT UCUNA UYGUNDUR. FOR PLBT INSERT. Kompatibel mit Wendeschneidplatte PLBT	4015-M4x9	80-T15	
AEM90-AP16P-D25-W25-L150-Z02	●	25	2	25	150	50	16				
AEM90-AP16P-D32-W32-L150-Z03	●	32	3	32	150	50	16				
AEM90-AP16P-D32-C32-L250-Z02	●	32	2	32	250	100	16				
AEM90-AP16P-D40-W32-L150-Z04	●	40	4	32	150	50	16	AP. 1604.. YG UCUNA UYGUNDUR. FOR YG INSERT. Kompatibel mit Wendeschneidplatte YG	4015-M4x9	80-T15	
AEM90-AP16Y-D25-C20-L100-Z02-H	●	25	2	20	100	35	16				
AEM90-AP16Y-D25-C25-L120-Z02	●	25	2	25	120	50	16				
AEM90-AP16Y-D25-C25-L150-Z02	●	25	2	25	150	50	16				
AEM90-AP16Y-D25-C25-L250-Z02	●	25	2	25	250	100	16	AP. 1705.. TGTC-LMN UCUNA UYGUNDUR. FOR TGTC-LMN INSERT. Kompatibel mit Wendeschneidplatte TGTC-LMN	4015-M4x9	80-T15	
AEM90-AP1705-D25-C25-L120-Z02	●	25	2	25	120	40	16				
AEM90-AP1705-D26-C25-L200-Z02	●	26	2	25	200	40	16				
AEM90-AP1705-D26-C25-L250-Z02	●	26	2	25	250	40	16				
AEM90-AP1705-D26-C25-L300-Z02	○	26	2	25	300	40	16				
AEM90-AP1705-D28-W25-L075-Z02	●	28	2	25	75	20	16				
AEM90-AP1705-D32-C25-L150-Z03	●	32	3	25	150	40	16				
AEM90-AP1705-D33-C32-L250-Z03	●	33	3	32	250	40	16				
AEM90-AP1705-D33-C32-L300-Z02	●	33	2	32	300	40	16				

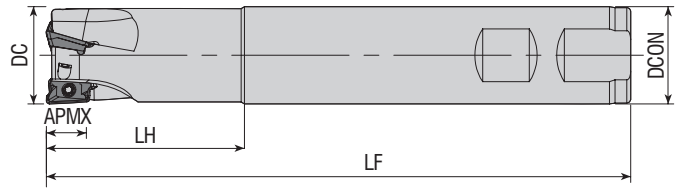

Takım Kodu Ordering Code Bestell-Bezeichnung	Stok Stock Lager	Takım Ölçüleri (mm) Dimension (mm) Abmessung (mm)						Kesici Uç Insert Wendeschneidplatte	Yedek Parçaları / Spare Parts / Ersatzteile		
		DC	ZEFP	DCON	LF	LH	APMX		Sıkma Vidası Screw Schraube	Tork Anahtar Torx Key Torx-Schlüssel	
AEM90-AO1236-D16-W16-L150-Z02	●	16	2	16	150	50	10	AO..1236..	3008-M2.5x6	80-T08	
AEM90-AO1236-D20-C20-L100-Z02	○	20	2	20	100	30	10				
AEM90-AO1236-D25-C25-L115-Z02	○	25	2	25	150	50	10				
AEM90-AO1236-D25-W25-L150-Z03	●	25	3	25	150	50	10				
AEM90-AO1236-D32-W32-L150-Z04	●	32	4	32	150	50	10				

R: Sağ / Right / Rechts L: Sol/Left/Links

● Stokta / In Stock / Auf Lager ○ Stokta Yok / Non Stock Item / Kein Lagerartikel, Lieferzeit auf Anfrage  
MTSBH Ucuna Uygun. / Compatiple with MTSBH Insert. Kompatibel mit MTSBH Wendepalten.

Sipariş Örneği/Ordering Example/Bestellbeispiel  
1 ad./pcs./stück AEM90-AP16P-D25-W25-L100-Z02-H  
Kesme Hesabı : S 367 / Cutting Calculation : P 367 / Schnittberechnung : 367

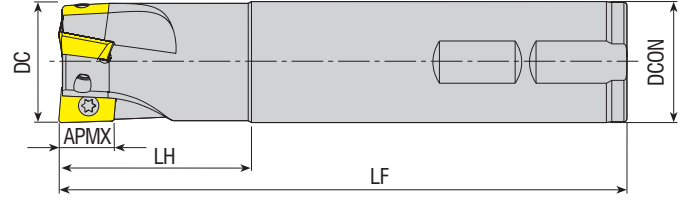

Takım Kodu Ordering Code Bestell-Bezeichnung	Stok Stock Lager	Takım Ölçüleri (mm) Dimension (mm) Abmessung (mm)						Kesici Uç Insert Wendeschneidplatte	Yedek Parçaları / Spare Parts / Ersatzteile	
		DC	ZEPF	DCON	LF	LH	APMX		Sıkma Vidası Screw Schraube	Tork Anahtar Torx Key Torx-Schlüssel
AEM90-AX0602-D10-C09-L120-Z02	●	10	2	9	120	20	5.7	AX.. 0602	3006-M1.8x4	80-T06
AEM90-AX0602-D10-C10-L080-Z02	●	10	2	10	80	20	5.7			
AEM90-AX0602-D10-C10-L120-Z02	●	10	2	10	120	20	5.7			
AEM90-AX0602-D12-C11-L120-Z02	●	12	2	11	120	20	5.7			
AEM90-AX0602-D12-C12-L080-Z02	●	12	2	12	80	20	5.7			
AEM90-AX0602-D12-C12-L120-Z02	●	12	2	12	120	20	5.7			
AEM90-AX0602-D14-C12-L120-Z03	●	14	3	12	120	20	5.7			
AEM90-AX0602-D16-W16-L120-Z04-H	●	16	4	16	120	20	5.7			
AEM90-AX0602-D16-W16-L150-Z04-H	●	16	4	16	150	20	5.7			
AEM90-AX0602-D20-W20-L120-Z05-H	●	20	5	20	120	25	5.7			
AEM90-AX0602-D20-W20-L150-Z05-H	●	20	5	20	150	25	5.7			
AEM90-AX0903-D16-C16-L120-Z02	●	16	2	16	120	30	8.8			
AEM90-AX0903-D16-C16-L180-Z02	●	16	2	16	180	30	8.8			
AEM90-AX0903-D17-C16-L120-Z02	●	17	2	16	120	25	8.8			
AEM90-AX0903-D17-C16-L180-Z02	●	17	2	16	180	25	8.8			
AEM90-AX0903-D20-C20-L120-Z03	●	20	3	20	120	30	8.8			
AEM90-AX0903-D20-C20-L200-Z02	●	20	2	20	200	30	8.8			
AEM90-AX0903-D21-C20-L120-Z03	●	21	3	20	120	25	8.8			
AEM90-AX0903-D21-C20-L200-Z02	●	21	2	20	200	25	8.8			
AEM90-AX0903-D25-C25-L150-Z03	●	25	3	25	150	30	8.8			
AEM90-AX0903-D25-C25-L250-Z02	●	25	2	25	250	40	8.8			
AEM90-AX0903-D26-C25-L150-Z03	●	26	3	25	150	30	8.8			

R: Sağ / Right / Rechts L: Sol/Left/Links  
● Stokta / In Stock / Auf Lager ○ Stokta Yok / Non Stock Item / Kein Lagerartikel, Lieferzeit auf Anfrage  
TGTC Ucuna Uygundur. / Compatible with TGTC Insert. Kompatibel mit TGTC Wendeplatten.

Sipariş Örneği/Ordering Example/Bestellbeispiel  
1 ad./pcs./stück AEM90-AX0602-D10-C09-L120-Z02  
Kesme Hesabı : S 367 / Cutting Calculation : P 367 / Schnittberechnung : 367





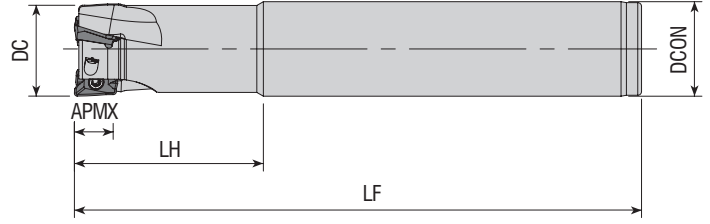

Takım Kodu Ordering Code Bestell-Bezeichnung	Stok Stock Lager	Takım Ölçüleri (mm) Dimension (mm) Abmessung (mm)						Kesici Uç Insert Wendeschneidplatte	Yedek Parçaları / Spare Parts / Ersatzteile			
		DC	ZEPF	DCON	LF	LH	APMX		Sıkma Vidası Screw Schraube	Tork Anahtar Torx Key Torx-Schlüssel		
AEM90-AX1235-D16-C14-L120-Z02-H	●	16	2	14	120	25	10	AX.T 1235..	3008-M3x6	80-T08		
AEM90-AX1235-D16-C15-L145-Z02-H	●	16	2	15	145	30	10		3108-M3x6			
AEM90-AX1235-D16-C16-L100-Z02-H	●	16	2	16	100	30	10		3008-M3x6			
AEM90-AX1235-D16-C16-L140-Z02-H	●	16	2	16	140	30	10		3108-M3x6			
AEM90-AX1235-D16-C16-L145-Z02-H	●	16	2	16	145	30	10		3008-M3x6			
AEM90-AX1235-D16-C16-L150-Z02	●	16	2	16	150	30	10		3108-M3x6			
AEM90-AX1235-D20-C19-L150-Z02-H	●	20	2	19	150	40	10		3008-M3x6			
AEM90-AX1235-D20-C20-L110-Z03-H	●	20	3	20	110	40	10		3108-M3x6			
AEM90-AX1235-D20-C20-L150-Z02	●	20	2	20	150	40	10		3008-M3x6			
AEM90-AX1235-D20-C20-L150-Z02-H	●	20	2	20	150	40	10		3108-M3x6			
AEM90-AX1235-D20-C20-L150-Z03	●	20	3	20	150	40	10		3008-M3x6			
AEM90-AX1235-D25-C20-L120-Z04-H	●	25	4	20	120	30	10		3108-M3x6			
AEM90-AX1235-D25-C20-L150-Z04-H	●	25	4	20	150	30	10		3008-M3x6			
AEM90-AX1235-D25-C24-L170-Z02-H	●	25	2	24	170	50	10		3108-M3x6			
AEM90-AX1235-D25-C25-L120-Z04-H	●	25	4	25	120	40	10		3008-M3x6			
AEM90-AX1235-D25-C25-L150-Z03	●	25	3	25	150	50	10		3108-M3x6			
AEM90-AX1235-D25-C25-L170-Z02-H	●	25	2	25	170	50	10		3008-M3x6			
AEM90-AX1235-D25-W25-L100-Z04-H	●	25	4	25	100	30	10		3108-M3x6			
AEM90-AX1235-D32-C32-L130-Z05-H	●	32	5	32	130	40	10		AX.T 1705..		4015-M4x9	80-T15
AEM90-AX1235-D32-C32-L180-Z02-H	●	32	2	32	180	50	10					
AEM90-AX1705-D25-C25-L150-Z02	●	25	2	25	150	50	14					
AEM90-AX1705-D28-W25-L115-Z02-H	●	28	2	25	115	35	14					
AEM90-AX1705-D32-C32-L150-Z03	●	32	3	32	150	50	14					
AEM90-AX1705-D32-C32-L180-Z02-H	●	32	2	32	180	50	14					

R: Sağ / Right / Rechts L: Sol/Left/Links

● Stokta / In Stock / Auf Lager ○ Stokta Yok / Non Stock Item / Kein Lagerartikel, Lieferzeit auf Anfrage  
SMTM Ucuna Uygunudur. / Compatible with SMTM Insert. Kompatibel mit SMTM Wendeplatten.

Sipariş Örneği/Ordering Example/Bestellbeispiel  
1 ad./pcs./stück AEM90-AX1235-D16-C14-L120-Z02-H  
Kesme Hesabı : S 367 / Cutting Calculation : P 367 / Schnittberechnung : 367

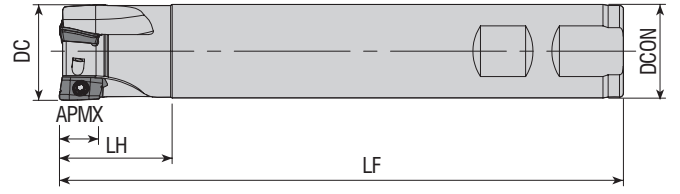

Takım Kodu Ordering Code Bestell-Bezeichnung	Stok Stock Lager	Takım Ölçüleri (mm) Dimension (mm) Abmessung (mm)						Kesici Uç Insert Wendeschneidplatte	Yedek Parçaları / Spare Parts / Ersatzteile	
		DC	ZEFP	DCON	LF	LH	APMX		Sıkma Vidası Screw Schraube	Tork Anahtar Torx Key Torx-Schlüssel
AEM90-AZ11-D12-W16-L90-Z01	●	12	1	16	90	30	11	AZGT 1135..	3008-M2.5X5	
AEM90-AZ11-D16-C16-L200-Z02	●	16	2	16	200	100	11			
AEM90-AZ11-D16-W15-L170-Z02	●	16	2	15	170	50	11			
AEM90-AZ11-D16-W16-L100-Z02	●	16	2	16	100	35	11			
AEM90-AZ11-D16-W16-L150-Z02	●	16	2	16	150	50	11			
AEM90-AZ11-D17-C16-L150-Z02	●	17	2	16	150	30	11			
AEM90-AZ11-D17-C16-L180-Z02	●	17	2	16	180	50	11			
AEM90-AZ11-D17-W16-L100-Z02	●	17	2	16	100	30	11			
AEM90-AZ11-D18-W16-L120-Z02	●	18	2	16	120	18	11		3008-M2.5X6	80-T08
AEM90-AZ11-D20-C20-L200-Z03	●	20	3	20	200	100	11			
AEM90-AZ11-D20-W19-L170-Z03	●	20	3	19	170	50	11			
AEM90-AZ11-D20-W20-L110-Z02	●	20	2	20	110	35	11			
AEM90-AZ11-D21-C20-L150-Z03	●	21	3	20	150	30	11			
AEM90-AZ11-D21-C20-L180-Z03	●	21	3	20	180	50	11			
AEM90-AZ11-D21-W20-L110-Z03	●	21	3	20	110	35	11			
AEM90-AZ11-D22-C20-L150-Z02	●	22	2	20	150	30	11			
AEM90-AZ11-D25-C24-L180-Z04	●	25	4	24	180	50	11			
AEM90-AZ11-D25-W25-L110-Z04	●	25	4	25	110	40	11			
AEM90-AZ11-D26-C25-L250-Z02	●	26	2	25	250	50	11			
AEM90-AZ11-D26-W25-L120-Z03	●	26	3	25	120	30	11			
AEM90-AZ11-D26-W25-L120-Z04	●	26	4	25	120	40	11			
AEM90-AZ11-D28-C25-L180-Z03	●	28	3	25	180	50	11			
AEM90-AZ11-D28-C25-L250-Z02	●	28	2	25	250	50	11			
AEM90-AZ11-D33-W32-L130-Z04	●	33	4	32	130	50	11			

R: Sağ / Right / Rechts L: Sol/Left/Links  
● Stokta / In Stock / Auf Lager ○ Stokta Yok / Non Stock Item / Kein Lagerartikel, Lieferzeit auf Anfrage  
ZCC Ucuna Uygunudur. / Compatible with ZCC Insert. Kompatibel mit ZCC Wendepplatten.

Sipariş Örneği/Ordering Example/Bestellbeispiel  
1 ad./pcs./stück AEM90-AZ11-D12-W16-L90-Z01  
Kesme Hesabı : S 367 / Cutting Calculation : P 367 / Schnittberechnung : 367

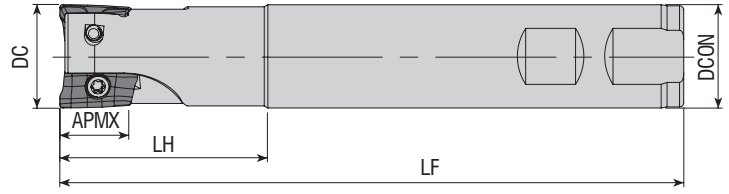

**Takım Kodu**  
**Ordering Code**  
**Bestell-Bezeichnung**

Stok  
Stock  
Lager

Takım Ölçüleri (mm)  
Dimension (mm)  
Abmessung (mm)

Kesici Uç  
Insert  
Wendeschneidplatte

Yedek Parçaları / Spare Parts / Ersatzteile

Sıkma Vidası  
Screw  
Schraube

Tork Anahtar  
Torx Key  
Torx-Schlüssel

DC ZEFP DCON LF LH APMX



AEM90-BD11T3-D16-C16-L100-Z02-H	●	16	2	16	100	30	10
AEM90-BD11T3-D16-W16-L100-Z02-H	●	16	2	16	100	30	10
AEM90-BD11T3-D16-W16-L150-Z02	●	16	2	16	150	50	10
AEM90-BD11T3-D16-C16-L160-Z02-H	●	16	2	16	160	50	10
AEM90-BD11T3-D16-C15-L180-Z02	●	16	2	15	180	50	10
AEM90-BD11T3-D17-W16-L150-Z02	●	17	2	16	150	25	10
AEM90-BD11T3-D17-C16-L180-Z02	●	17	2	16	180	25	10
AEM90-BD11T3-D18-W16-L100-Z02	●	18	2	16	100	25	10
AEM90-BD11T3-D18-W16-L100-Z02-H	●	18	2	16	100	25	10
AEM90-BD11T3-D20-W20-L81-Z03-H	●	20	3	20	81	30	10
AEM90-BD11T3-D20-W20-L100-Z02-H	●	20	2	20	100	30	10
AEM90-BD11T3-D20-W20-L100-Z03-H	●	20	3	20	100	30	10
AEM90-BD11T3-D20-C20-L110-Z03-H	●	20	3	20	110	30	10
AEM90-BD11T3-D20-W20-L150-Z02	●	20	2	20	150	50	10
AEM90-BD11T3-D20-W20-L150-Z03	●	20	3	20	150	50	10
AEM90-BD11T3-D20-W20-L150-Z03-H	●	20	3	20	150	50	10
AEM90-BD11T3-D20-C20-L170-Z03-H	●	20	3	20	170	50	10
AEM90-BD11T3-D21-W20-L150-Z03	●	21	3	20	150	25	10
AEM90-BD11T3-D21-C20-L200-Z02	●	21	2	20	200	25	10
AEM90-BD11T3-D22-W20-L090-Z02-H	●	22	2	20	90	25	10
AEM90-BD11T3-D25-W25-L100-Z03-H	●	25	3	25	100	30	10
AEM90-BD11T3-D25-C20-L120-Z03-H	●	25	3	20	120	30	10
AEM90-BD11T3-D25-C25-L120-Z03-H	●	25	3	25	120	30	10
AEM90-BD11T3-D25-W25-L150-Z03	●	25	3	25	150	50	10
AEM90-BD11T3-D26-W25-L150-Z03	●	26	3	25	150	35	10
AEM90-BD11T3-D26-C25-L250-Z02	●	26	2	25	250	35	10
AEM90-BD11T3-D32-W32-L110-Z04-H	●	32	4	32	110	40	10
AEM90-BD11T3-D32-C32-L130-Z04-H	●	32	4	32	130	40	10
AEM90-BD11T3-D32-W32-L150-Z04	●	32	4	32	150	50	10
AEM90-BD11T3-D40-W32-L110-Z04-H	●	40	4	32	110	35	10
AEM90-BD1704-D25-W25-L100-Z02-H	●	25	2	25	100	35	15.7
AEM90-BD1704-D25-W25-L150-Z02	●	25	2	25	150	50	15.7
AEM90-BD1704-D25-C25-L210-Z02-H	●	25	2	25	210	100	15.7
AEM90-BD1704-D32-W32-L110-Z03-H	●	32	3	32	110	40	15.7
AEM90-BD1704-D32-C32-L130-Z03-H	●	32	3	32	130	40	15.7
AEM90-BD1704-D32-W32-L130-Z03-H	●	32	3	32	130	40	15.7
AEM90-BD1704-D32-W32-L150-Z03	●	32	3	32	150	50	15.7
AEM90-BD1704-D40-W32-L110-Z04-H	●	40	4	32	110	40	15.7
AEM90-BD1704-D40-W32-L150-Z04	●	40	4	32	150	40	15.7

**BDMT 11T3..**

3008-M2.5x5

3008-M2.5x6

80-T08

**BDMT 1704..**

4015-M4x8

80-T15

R: Sağ / Right / Rechts L: Sol/Left/Links

● Stokta / In Stock / Auf Lager ○ Stokta Yok / Non Stock Item / Kein Lagerartikel, Lieferzeit auf Anfrage  
KYCR Ucuna Uygundur. / Compatible with KYCR Insert. Kompatibel mit KYCR Wendepplatten.

Sipariş Örneği/Ordering Example/Bestellbeispiel  
1 ad./pcs./stück AEM90-BD11T3-D16-C16-L100-Z02-H  
Kesme Hesabı : S 367 / Cutting Calculation : P 367 / Schnittberechnung : 367

KAPR=90°

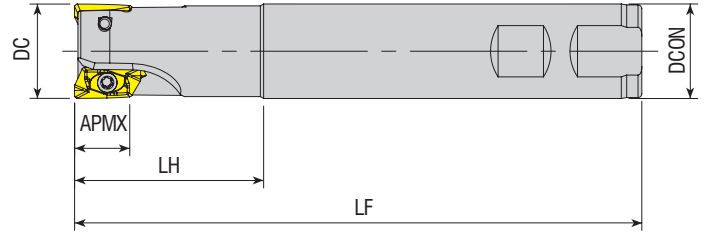

Takım Kodu Ordering Code Bestell-Bezeichnung	Stok Stock Lager	Takım Ölçüleri (mm) Dimension (mm) Abmessung (mm)						Kesici Uç Insert Wendeschneidplatte	Yedek Parçaları / Spare Parts / Ersatzteile	
		DC	ZEFP	DCON	LF	LH	APMX		Sıkma Vidası Screw Schraube	Tork Anahtar Torx Key Torx-Schlüssel
AEM90-ED10T3-D16-W16-L120-Z02	●	16	2	16	120	30	30	EDPT 10T3..	3008-M2.5x5	80-T08
AEM90-ED10T3-D20-W20-L120-Z02	●	20	2	20	120	30	30		3008-M2.5x6	
AEM90-ED1404-D20-W20-L150-Z02	●	20	2	20	150	50	14.5	EDPT 1404..	3008-M3x6	
AEM90-ED1404-D25-W25-L150-Z02	●	25	2	25	150	50	14.5			
AEM90-ED1404-D30-C25-L150-Z03	●	30	3	25	150	50	14.5			

KNMNTL Ucuna Uygundur. / Compatible with KNMNTL Insert. Kompatibel mit KNMNTL Wendeplatten.

KAPR=90°

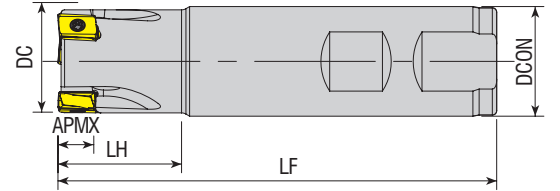

Takım Kodu Ordering Code Bestell-Bezeichnung	Stok Stock Lager	Takım Ölçüleri (mm) Dimension (mm) Abmessung (mm)						Kesici Uç Insert Wendeschneidplatte	Yedek Parçaları / Spare Parts / Ersatzteile	
		DC	ZEFP	DCON	LF	LH	APMX		Sıkma Vidası Screw Schraube	Tork Anahtar Torx Key Torx-Schlüssel
AEM90-LN08-D16-W16-L100-Z02-H	●	16	2	16	100	28	8	LNMT 0804..	1707-U4-48x6	80-T07
AEM90-LN08-D16-W16-L150-Z02	●	16	2	16	150	40	8			
AEM90-LN08-D20-W20-L100-Z03-H	●	20	3	20	100	28	8		1707-U4-48x8.2	
AEM90-LN08-D25-W25-L100-Z03-H	●	25	3	25	100	30	8			
AEM90-LN08-D32-W32-L110-Z05-H	●	32	5	32	110	30	8			

R: Sağ / Right / Rechts L: Sol/Left/Links

● Stokta / In Stock / Auf Lager ○ Stokta Yok / Non Stock Item / Kein Lagerartikel, Lieferzeit auf Anfrage  
ISCR Ucuna Uygundur. / Compatible with ISCR Insert. Kompatibel mit ISCR Wendeplatten.

Sipariş Örneği/Ordering Example/Bestellbeispiel

1 ad./pcs./stück AEM90-ED10T3-D16-W16-L120-Z02

Kesme Hesabı : S 367 / Cutting Calculation : P 367 / Schnittberechnung : 367



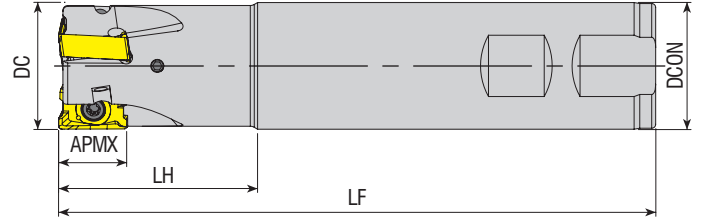

Takım Kodu Ordering Code Bestell-Bezeichnung	Stok Stock Lager	Takım Ölçüleri (mm) Dimension (mm) Abmessung (mm)						Kesici Uç Insert Wendeschneidplatte	Yedek Parçaları / Spare Parts / Ersatzteile	
		DC	ZEFP	DCON	LF	LH	APMX		Sıkma Vidası Screw Schraube	Tork Anahtar Torx Key Torx-Schlüssel
AEM90-LN15T6-D25-W25-L150-Z02-H	●	25	2	25	150	50	15.5	LNGU 15T6..	4015-M4x12	80-T15
AEM90-LN15T6-D32-W32-L150-Z03-H	●	32	3	32	150	50	15.5			
AEM90-LN15T6-D40-W32-L150-Z03-H	●	40	3	32	150	40	15.5			

KNMTL Ucuna Uygunur. / Compatible with KNMTL Insert. Kompatibel mit KNMTL Wendeplatten.

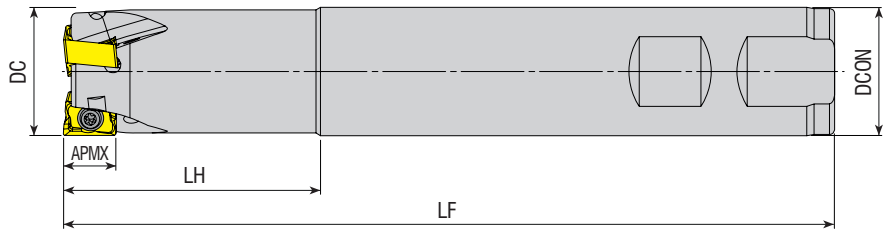

Takım Kodu Ordering Code Bestell-Bezeichnung	Stok Stock Lager	Takım Ölçüleri (mm) Dimension (mm) Abmessung (mm)						Kesici Uç Insert Wendeschneidplatte	Yedek Parçaları / Spare Parts / Ersatzteile	
		DC	ZEFP	DCON	LF	LH	APMX		Sıkma Vidası Screw Schraube	Tork Anahtar Torx Key Torx-Schlüssel
AEM90-LN1006-D16-W16-L120-Z01-H	●	16	1	16	120	30	9	LN.X 1006..	4010-M3x8	80-T10
AEM90-LN1006-D16-W16-L150-Z01	●	16	1	16	150	50	9			
AEM90-LN1006-D18-W16-L120-Z02-H	●	18	2	16	120	30	9			
AEM90-LN1006-D20-W20-L120-Z02-H	●	20	2	20	120	30	9			
AEM90-LN1006-D20-W20-L150-Z02	●	20	2	20	150	50	9			
AEM90-LN1006-D25-W25-L120-Z03-H	●	25	3	25	120	30	9			
AEM90-LN1006-D25-W25-L150-Z03	●	25	3	25	150	50	9			
AEM90-LN1006-D32-W32-L120-Z04-H	●	32	4	32	120	30	9			
AEM90-LN1006-D32-W32-L150-Z04	●	32	4	32	150	50	9			

R: Sağ / Right / Rechts L: Sol/Left/Links

● Stokta / In Stock / Auf Lager ○ Stokta Yok / Non Stock Item / Kein Lagerartikel, Lieferzeit auf Anfrage

KRYL Ucuna Uygunur. / Compatible with KRYL Insert. Kompatibel mit KRYL Wendeplatten.

Sipariş Örneği/Ordering Example/Bestellbeispiel

1 ad./pcs./stück AEM90-LN15T6-D25-W25-L150-Z02-H

Kesme Hesabı : S 367 / Cutting Calculation : P 367 / Schnittberechnung : 367

# S-SİSTEM YÜZEY PARMAK FREZELER

S-SYSTEM END MILLS

S-SYSTEM SCHAFTFRÄSER

KAPR=90°

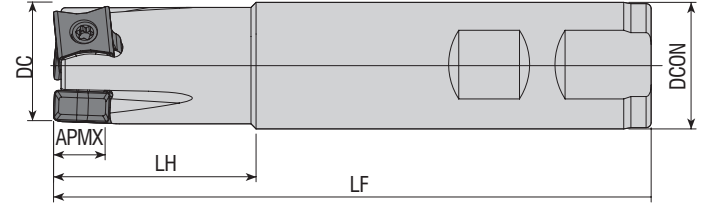

**Takım Kodu**  
**Ordering Code**  
**Bestell-Bezeichnung**

Stok  
Stock  
Lager

Takım Ölçüleri (mm)  
Dimension (mm)  
Abmessung (mm)

Kesici Uç  
Insert  
Wendeschneidplatte

Yedek Parçaları / Spare Parts / Ersatzteile

Sıkma Vidası  
Screw  
Schraube

Tork Anahtar  
Torx Key  
Torx-Schlüssel

AEM90-LN1106-D25-W25-L150-Z03  
AEM90-LN1106-D32-W32-L150-Z04  
AEM90-LN1106-D40-W32-L150-Z05

Stok	DC	ZEFP	DCON	LF	LH	APMX
●	25	3	25	150	40	10
●	32	4	32	150	40	10
●	40	5	32	150	40	10



LNMT 1106..

4015-M3.5x11

80-T15

ISCR-XTC-GSC Ucuna Uygundur. / Compatible with ISCR-XTC-GSC Insert. Kompatibel mit ISCR-XTC-GSC Wendeplatten.

KAPR=90°

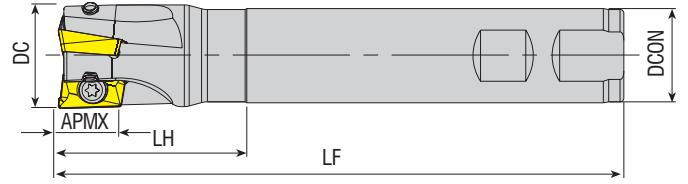

**Takım Kodu**  
**Ordering Code**  
**Bestell-Bezeichnung**

Stok  
Stock  
Lager

Takım Ölçüleri (mm)  
Dimension (mm)  
Abmessung (mm)

Kesici Uç  
Insert  
Wendeschneidplatte

Yedek Parçaları / Spare Parts / Ersatzteile

Sıkma Vidası  
Screw  
Schraube

Tork Anahtar  
Torx Key  
Torx-Schlüssel

AEM90-R390.11-D12-W12-L100-Z01  
AEM90-R390.11-D16-W16-L100-Z02-H  
AEM90-R390.11-D16-W16-L150-Z02  
AEM90-R390.11-D16-W16-L150-Z02-H  
AEM90-R390.11-D20-W20-L090-Z02-H  
AEM90-R390.11-D20-W20-L100-Z03-H  
AEM90-R390.11-D20-W20-L150-Z03  
AEM90-R390.11-D20-W20-L150-Z03-H  
AEM90-R390.11-D20-C20-L150-Z03  
AEM90-R390.11-D22-W20-L090-Z02-H  
AEM90-R390.11-D25-C20-L150-Z03  
AEM90-R390.11-D25-W25-L100-Z03-H  
AEM90-R390.11-D25-W25-L150-Z03  
AEM90-R390.11-D25-W25-L150-Z03-H  
AEM90-R390.11-D30-W25-L150-Z04-H  
AEM90-R390.11-D32-C25-L200-Z03  
AEM90-R390.11-D32-W32-L150-Z05-H  
AEM90-R390.17-D25-W25-L150-Z02  
AEM90-R390.17-D25-W25-L150-Z02-H  
AEM90-R390.17-D30-W25-L150-Z03  
AEM90-R390.17-D30-W25-L150-Z03-H  
AEM90-R390.17-D32-W32-L150-Z03-H  
AEM90-R390.18-D32-C32-L150-Z03

Stok	DC	ZEFP	DCON	LF	LH	APMX
●	12	1	12	100	25	10
●	16	2	16	100	30	10
●	16	2	16	150	50	10
●	16	2	16	150	50	10
●	20	2	20	90	30	10
●	20	3	20	100	30	10
●	20	3	20	150	50	10
●	20	3	20	150	50	10
●	20	3	20	150	30	10
●	22	2	20	90	30	10
●	25	3	20	150	40	10
●	25	3	25	100	30	10
●	25	3	25	150	50	10
●	25	3	25	150	50	10
●	25	3	25	150	50	10
●	30	4	25	150	30	10
●	32	3	25	200	40	10
●	32	5	32	150	50	10
●	25	2	25	150	50	15.4
●	25	2	25	150	50	15.4
●	30	3	25	150	40	15.4
●	30	3	25	150	40	15.4
●	32	3	32	150	40	15.4
●	32	3	32	150	45	15.4



R390-11T3..

3008-M2.5x5

80-T08

R390-1704..

4015-M3.5x8

80-T15

R390-1806..

4015-M4x11

R: Sağ / Right / Rechts L: Sol/Left/Links

● Stokta / In Stock / Auf Lager ○ Stokta Yok / Non Stock Item / Kein Lagerartikel, Lieferzeit auf Anfrage  
SNDVK Ucuna Uygundur. / Compatible with SNDVK Insert. Kompatibel mit SNDVK Wendeplatten.

Sipariş Örneği/Ordering Example/Bestellbeispiel

1 ad./pcs./stück AEM90-LN1106-D25-W25-L150-Z03

Kesme Hesabı : S 367 / Cutting Calculation : P 367 / Schnittberechnung : 367



www.akko.com.tr

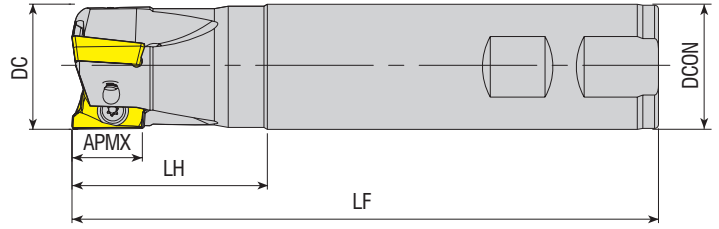

Takım Kodu Ordering Code Bestell-Bezeichnung	Stok Stock Lager	Takım Ölçüleri (mm) Dimension (mm) Abmessung (mm)						Kesici Uç Insert Wendeschneidplatte	Yedek Parçaları / Spare Parts / Ersatzteile	
		DC	ZEPF	DCON	LF	LH	APMX		Sıkma Vidası Screw Schraube	Tork Anahtar Torx Key Torx-Schlüssel
AEM90-RT07-D10-W10-L120-Z02	●	10	2	10	120	30	7	RT 0702	3006-M2x4	80-T06
AEM90-RT07-D12-C12-L120-Z02	●	12	2	12	120	30	7			
AEM90-RT07-D12-W12-L120-Z02	●	12	2	12	120	30	7			
AEM90-RT07-D14-W12-L120-Z02	●	14	2	12	120	30	7			
AEM90-RT10-D16-C15-L160-Z02	●	16	2	15	160	30	10	RT 1003	3008-M2.5x6	80-T08
AEM90-RT10-D16-W16-L120-Z02-H	●	16	2	16	120	30	10			
AEM90-RT10-D16-W16-L150-Z02	●	16	2	16	150	30	10			
AEM90-RT10-D16-C16-L200-Z02	●	16	2	16	200	100	10			
AEM90-RT10-D17-W16-L160-Z02	●	17	2	16	160	30	10			
AEM90-RT10-D17-C16-L200-Z02	●	17	2	16	200	30	10			
AEM90-RT10-D18-W16-L120-Z02-H	●	18	2	16	120	30	10			
AEM90-RT10-D20-C19-L200-Z03	●	20	3	19	200	30	10			
AEM90-RT10-D20-C20-L110-Z03	●	20	3	20	110	30	10			
AEM90-RT10-D20-W20-L120-Z03-H	●	20	3	20	120	30	10			
AEM90-RT10-D20-W20-L150-Z03	●	20	3	20	150	50	10			
AEM90-RT10-D20-C20-L200-Z03	●	20	3	20	200	100	10			
AEM90-RT10-D21-W20-L200-Z03	●	21	3	20	200	30	10			
AEM90-RT10-D22-W20-L120-Z03-H	●	22	3	20	120	30	10			
AEM90-RT10-D22-C20-L150-Z03	●	22	3	20	150	30	10			
AEM90-RT10-D22-C20-L200-Z03	●	22	3	20	200	30	10			
AEM90-RT10-D25-W25-L120-Z04-H	●	25	4	25	120	40	10			
AEM90-RT10-D25-W25-L150-Z04	●	25	4	25	150	50	10			
AEM90-RT10-D25-C25-L200-Z04	●	25	4	25	200	100	10			
AEM90-RT10-D26-C25-L250-Z04	●	26	4	25	250	32	10			
AEM90-RT10-D32-W32-L120-Z05-H	●	32	5	32	120	50	10			
AEM90-RT10-D32-W32-L150-Z05	●	32	5	32	150	50	10			
AEM90-RT10-D32-C32-L200-Z05	●	32	5	32	200	100	10			
AEM90-RT10-D33-C32-L250-Z04	●	33	4	32	250	32	10			
AEM90-RT13-D32-C32-L250-Z04	●	32	4	32	250	50	13	RT 1304	3008-M3x8	
AEM90-RT16-D25-W25-L120-Z02-H	●	25	2	25	120	40	16	RT 1606	4015-M4x9	80-T15
AEM90-RT16-D25-W25-L150-Z02	●	25	2	25	150	50	16			
AEM90-RT16-D25-C25-L200-Z02	●	25	2	25	200	100	16			
AEM90-RT16-D32-W32-L120-Z03-H	●	32	3	32	120	50	16			
AEM90-RT16-D32-W32-L150-Z03	●	32	3	32	150	50	16			
AEM90-RT16-D32-C32-L200-Z03	●	32	3	32	200	100	16			
AEM90-RT16-D32-C32-L250-Z03	●	32	3	32	250	100	16			
AEM90-RT16-D32-C32-L270-Z03	●	32	3	32	270	100	16			
AEM90-RT16-D40-W32-L120-Z04-H	●	40	4	32	120	50	16			
AEM90-RT16-D40-W32-L150-Z04	●	40	4	32	150	50	16			
AEM90-RT16-D40-C32-L200-Z04	●	40	4	32	200	100	16		4015-M4x11	

R: Sağ / Right / Rechts L: Sol/Left/Links

● Stokta / In Stock / Auf Lager ○ Stokta Yok / Non Stock Item / Kein Lagerartikel, Lieferzeit auf Anfrage  
SFTY Ucuna Uygunudur. / Compatible with SFTY Insert. Kompatibel mit SFTY Wendeplatten.

Sipariş Örneği/Ordering Example/Bestellbeispiel

1 ad./pcs./stück AEM90-RT07-D10-W10-L120-Z02

Kesme Hesabı : S 367 / Cutting Calculation : P 367 / Schnittberechnung : 367

KAPR=90°

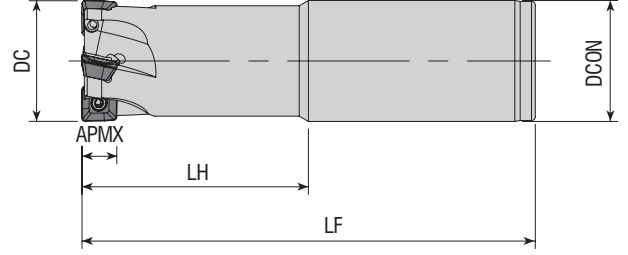

Takım Kodu Ordering Code Bestell-Bezeichnung	Stok Stock Lager	Takım Ölçüleri (mm) Dimension (mm) Abmessung (mm)						Kesici Uç Insert Wendeschneidplatte	Yedek Parçaları / Spare Parts / Ersatzteile		
		DC	ZEFP	DCON	LF	LH	APMX		Sıkma Vidası Screw Schraube	Tork Anahtar Torx Key Torx-Schlüssel	
AEM90-SE09-D25-C25-L120-Z03-H	●	25	3	25	120	60	6.7	SEET 09T3..	3008-M3x8	80-T08	
AEM90-SE09-D25-C25-L150-Z02	●	25	2	25	150	50	6.7				
AEM90-SE09-D32-C32-L120-Z04-H	●	32	4	32	120	60	6.7				
AEM90-SE09-D32-C32-L150-Z03	●	32	3	32	150	50	6.7				

ZCC Ucuna Uygun. / Compatiple with ZCC Insert. Kompatibel mit ZCC Wendeplatten.

KAPR=90°

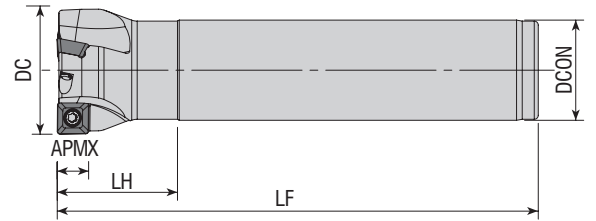

Takım Kodu Ordering Code Bestell-Bezeichnung	Stok Stock Lager	Takım Ölçüleri (mm) Dimension (mm) Abmessung (mm)						Kesici Uç Insert Wendeschneidplatte	Yedek Parçaları / Spare Parts / Ersatzteile		
		DC	ZEFP	DCON	LF	LH	APMX		Sıkma Vidası Screw Schraube	Tork Anahtar Torx Key Torx-Schlüssel	
AEM90-S00803-D20-C16-L110-Z02-H	●	20	2	16	110	25	7	SOMT 0803..	3008-M3x7	80-T08	
AEM90-S00803-D25-C20-L110-Z02-H	●	25	2	20	110	25	7				
AEM90-S00803-D32-C25-L120-Z03-H	●	32	3	25	120	30	7				

R: Sağ / Right / Rechts L: Sol/Left/Links

● Stokta / In Stock / Auf Lager ○ Stokta Yok / Non Stock Item / Kein Lagerartikel, Lieferzeit auf Anfrage  
SMTM Ucuna Uygun. / Compatiple with SMTM Insert. Kompatibel mit SMTM Wendeplatten.

Sipariş Örneği/Ordering Example/Bestellbeispiel

1 ad./pcs./stück AEM90-SE09-D25-C25-L120-Z03-H

Kesme Hesabı : S 367 / Cutting Calculation : P 367 / Schnittberechnung : 367



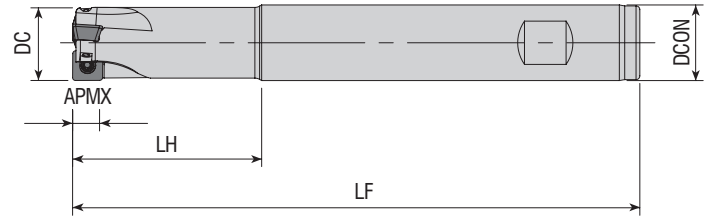

Takım Kodu Ordering Code Bestell-Bezeichnung	Stok Stock Lager	Takım Ölçüleri (mm) Dimension (mm) Abmessung (mm)						Kesici Uç Insert Wendeschneidplatte	Yedek Parçaları / Spare Parts / Ersatzteile	
		DC	ZEFP	DCON	LF	LH	APMX		Sıkma Vidası Screw Schraube	Tork Anahtar Torx Key Torx-Schlüssel
AEM90-SPGT0602-D16-W16-L150-Z02	●	16	2	16	150	50	5.5			
AEM90-SPGT07T3-D20-W20-L150-Z03	●	20	3	20	150	50	7			
AEM90-SPGT07T3-D25-W25-L150-Z03	●	25	3	25	150	50	7			
AEM90-SPGT0904-D30-W32-L150-Z03	●	30	3	32	150	50	9			

ZCC Ucuna Uygunudur. / Compatible with ZCC Insert. Kompatibel mit ZCC Wendepfatten.

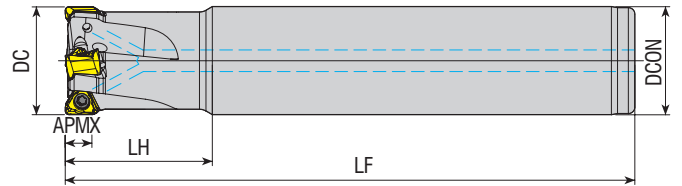

Takım Kodu Ordering Code Bestell-Bezeichnung	Stok Stock Lager	Takım Ölçüleri (mm) Dimension (mm) Abmessung (mm)						Kesici Uç Insert Wendeschneidplatte	Yedek Parçaları / Spare Parts / Ersatzteile	
		DC	ZEFP	DCON	LF	LH	APMX		Sıkma Vidası Screw Schraube	Tork Anahtar Torx Key Torx-Schlüssel
AEM90-TNG10-D20-C20-L125-Z02-H	●	20	2	20	125	29	5			
AEM90-TNG10-D20-C20-L125-Z03-H	●	20	3	20	125	29	5			
AEM90-TNG10-D20-C20-L150-Z03-H	○	20	3	20	150	50	5			
AEM90-TNG10-D21-C20-L200-Z03-H	●	21	3	20	200	30	5			
AEM90-TNG10-D25-C25-L150-Z03-H	●	25	3	25	150	34	5			
AEM90-TNG10-D25-C25-L150-Z04-H	●	25	4	25	150	34	5			
AEM90-TNG10-D25-C25-L170-Z04-H	○	25	4	25	170	50	5			
AEM90-TNG10-D26-C25-L250-Z04-H	●	26	4	25	250	35	5			
AEM90-TNG10-D32-C32-L170-Z04-H	●	32	4	32	170	37	5			
AEM90-TNG10-D32-C32-L170-Z05-H	○	32	5	32	170	37	5			
AEM90-TNG10-D33-C32-L250-Z05-H	●	33	5	32	250	35	5			

R: Sağ / Right / Rechts L: Sol/Left/Links

● Stokta / In Stock / Auf Lager ○ Stokta Yok / Non Stock Item / Kein Lagerartikel, Lieferzeit auf Anfrage  
PRMT Ucuna Uygunudur. / Compatible with PRMT Insert. Kompatibel mit PRMT Wendepfatten.

Sipariş Örneği/Ordering Example/Bestellbeispiel

1 ad./pcs./stück AEM90-SPGT0602-D16-W16-L150-Z02

Kesme Hesabı : S 367 / Cutting Calculation : P 367 / Schnittberechnung : 367



KAPR=90°

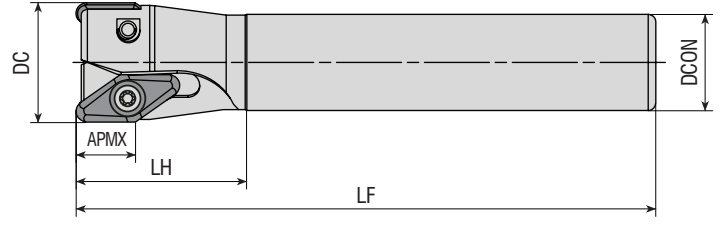

Takım Kodu Ordering Code Bestell-Bezeichnung	Stok Stock Lager	Takım Ölçüleri (mm) Dimension (mm) Abmessung (mm)						Kesici Uç Insert Wendeschneidplatte	Yedek Parçaları / Spare Parts / Ersatzteile	
		DC	ZEFP	DCON	LF	LH	APMX		Sıkma Vidası Screw Schraube	Tork Anahtar Torx Key Torx-Schlüssel
AEM90-VC2205-D32-C25-L150-Z02-H	●	32	2	25	150	50	15	VCKT 2205..		
AEM90-VC2205-D40-C32-L150-Z03-H	●	40	3	32	150	50	15			

ISO Ucuna Uygundur. / Compatible with ISO Insert. Kompatibel mit ISO Wendeschneidplatten.



KAPR=90°

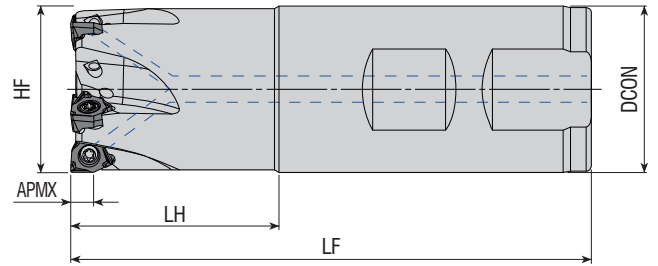

Takım Kodu Ordering Code Bestell-Bezeichnung	Stok Stock Lager	Takım Ölçüleri (mm) Dimension (mm) Abmessung (mm)						Kesici Uç Insert Wendeschneidplatte	Yedek Parçaları / Spare Parts / Ersatzteile	
		DC	ZEFP	DCON	LF	LH	APMX		Sıkma Vidası Screw Schraube	Tork Anahtar Torx Key Torx-Schlüssel
AEM90-WNG04-D20-W20-L81-Z03-H	●	20	3	20	81	31	4	WNGU 0403..		
AEM90-WNG04-D20-C20-L170-Z03-H	●	20	3	20	170	50	4			
AEM90-WNG04-D25-W25-L88-Z03-H	●	25	3	25	88	32	4			
AEM90-WNG04-D25-W25-L88-Z04-H	●	25	4	25	88	32	4			
AEM90-WNG04-D25-C25-L170-Z03-H	●	25	3	25	170	50	4			
AEM90-WNG04-D32-W25-L100-Z05-H	●	32	5	25	100	35	4			
AEM90-WNG04-D32-W32-L100-Z05-H	●	32	5	32	100	40	4			
AEM90-WNG04-D32-C25-L170-Z04-H	●	32	4	25	170	35	4			
AEM90-WNG04-D32-C32-L170-Z04-H	●	32	4	32	170	50	4			
AEM90-WNG08-D40-W32-L100-Z03-H	●	40	3	32	100	35	7.5			
AEM90-WNG08-D40-C32-L170-Z03-H	●	40	3	32	170	35	7.5			

R: Sağ / Right / Rechts L: Sol/Left/Links

● Stokta / In Stock / Auf Lager ○ Stokta Yok / Non Stock Item / Kein Lagerartikel, Lieferzeit auf Anfrage

XTC-GSC Ucuna Uygundur. / Compatible with XTC-GSC Insert. Kompatibel mit XTC-GSC Wendeschneidplatten.

Sipariş Örneği/Ordering Example/Bestellbeispiel

1 ad./pcs./stück AEM90-VC2205-D32-C25-L150-Z02-H



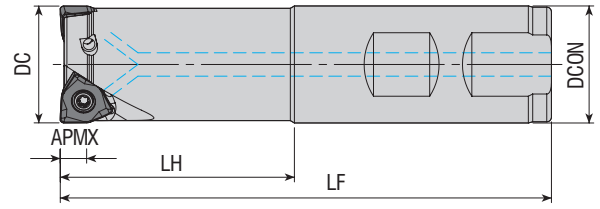

Takım Kodu Ordering Code Bestell-Bezeichnung	Stok Stock Lager	Takım Ölçüleri (mm) Dimension (mm) Abmessung (mm)						Kesici Uç Insert Wendeschneidplatte	Yedek Parçaları / Spare Parts / Ersatzteile	
		DC	ZEPF	DCON	LF	LH	APMX		Sıkma Vidası Screw Schraube	Tork Anahtar Torx Key Torx-Schlüssel
AEM90L-WN0604Z-D25-C25-L200-Z02-H	●	25	2	25	200	100	5.7	WNHU 0604..	3008-M3x8	80-T08
AEM90-WN0604Z-D25-W25-L150-Z02-H	●	25	2	25	150	50	5.7			
AEM90-WN0604Z-D32-W32-L150-Z03-H	●	32	3	32	150	50	5.7			
AEM90-WN0604Z-D40-W32-L150-Z04-H	●	40	4	32	150	35	5.7			

ZCC Ucuna Uygun. / Compatible with ZCC Insert. Kompatibel mit ZCC Wendepfatten.

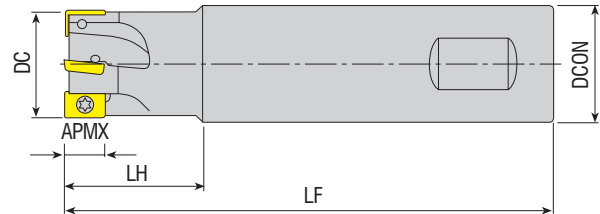

Takım Kodu Ordering Code Bestell-Bezeichnung	Stok Stock Lager	Takım Ölçüleri (mm) Dimension (mm) Abmessung (mm)						Kesici Uç Insert Wendeschneidplatte	Yedek Parçaları / Spare Parts / Ersatzteile	
		DC	ZEPF	DCON	LF	LH	APMX		Sıkma Vidası Screw Schraube	Tork Anahtar Torx Key Torx-Schlüssel
AEM90-XD11T3-D16-W16-L150-Z02	●	16	2	16	150	30	10	XD.T 11T3..	3008-M2.5x5	80-T08
AEM90-XD11T3-D17-C16-L150-Z02	●	17	2	16	150	30	10			
AEM90-XD11T3-D20-W20-L150-Z03	●	20	3	20	150	50	10			
AEM90-XD11T3-D21-C20-L080-Z03-H	●	21	3	20	80	25	10			
AEM90-XD11T3-D21-C20-L150-Z03	●	21	3	20	150	30	10			
AEM90-XD11T3-D25-W25-L150-Z04	●	25	4	25	150	50	10			
AEM90-XD11T3-D30-W25-L120-Z04	●	30	4	25	120	30	10			
AEM90-XD11T3-D32-W32-L150-Z04	●	32	4	32	150	50	10			
AEM90-XD11T3-D33-C20-L080-Z04-H	●	33	4	20	80	30	10			

R: Sağ / Right / Rechts L: Sol/Left/Links

● Stokta / In Stock / Auf Lager ○ Stokta Yok / Non Stock Item / Kein Lagerartikel, Lieferzeit auf Anfrage  
CRTZT Ucuna Uygun. / Compatible with CRTZT Insert. Kompatibel mit CRTZT Wendepfatten.

Sipariş Örneği/Ordering Example/Bestellbeispiel

1 ad./pcs./stück AEM90L-WN0604Z-D25-C25-L200-Z02-H

Kesme Hesabı : S 367 / Cutting Calculation : P 367 / Schnittberechnung : 367

KAPR=90°

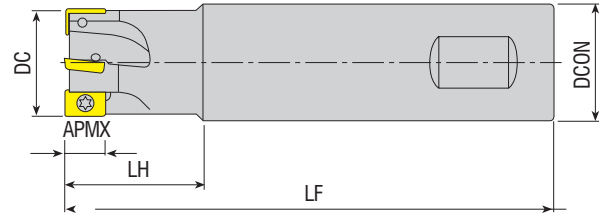

Takım Kodu Ordering Code Bestell-Bezeichnung	Stok Stock Lager	Takım Ölçüleri (mm) Dimension (mm) Abmessung (mm)						Kesici Uç Insert Wendeschneidplatte	Yedek Parçaları / Spare Parts / Ersatzteile	
		DC	ZEPF	DCON	LF	LH	APMX		Sıkma Vidası Screw Schraube	Tork Anahtar Torx Key Torx-Schlüssel
AEM90-XC13-D20-W20-L150-Z02	●	20	2	20	150	60	13	XCKX 13T3..	3008-M3x6	80-T08
AEM90-XC13-D25-W25-L150-Z03	●	25	3	25	150	60	13		3008-M3x8	
AEM90-XC13-D32-W32-L150-Z04	●	32	4	32	150	60	13			

SC Ucuna Uygun. / Compatible with SC Insert. Kompatibel mit SC Wendeplatten.

KAPR=90°

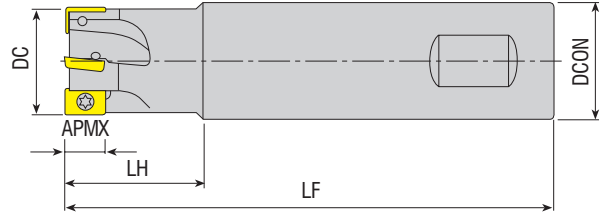

Takım Kodu Ordering Code Bestell-Bezeichnung	Stok Stock Lager	Takım Ölçüleri (mm) Dimension (mm) Abmessung (mm)						Kesici Uç Insert Wendeschneidplatte	Yedek Parçaları / Spare Parts / Ersatzteile	
		DC	ZEPF	DCON	LF	LH	APMX		Sıkma Vidası Screw Schraube	Tork Anahtar Torx Key Torx-Schlüssel
AEM90-X006-D10-C12-L120-Z02	●	10	2	12	120	50	5	XO.. 0602..	3006-M1.8x4	80-T06
AEM90-X006-D12-C12-L120-Z02	●	12	2	12	120	25	5			
AEM90-X009-D16-W16-L150-Z02	●	16	2	16	150	50	8	XO.. 0903..	3008-M2.5x5	80-T08
AEM90-X009-D20-W20-L150-Z03	●	20	3	20	150	50	8			
AEM90-X012-D20-W20-L150-Z02	●	20	2	20	150	50	11	XO.. 1204..	3010-M3.5x7	80-T10
AEM90-X012-D20-C20-L200-Z02	●	20	2	20	200	100	11			
AEM90-X012-D22-W20-L150-Z02	●	22	2	20	150	30	11			
AEM90-X012-D25-W25-L150-Z03	●	25	3	25	150	50	11			
AEM90-X012-D25-C25-L200-Z03	●	25	3	25	200	100	11			
AEM90-X012-D32-C25-L150-Z04	●	32	4	25	150	40	11			
AEM90-X012-D32-W32-L150-Z04	●	32	4	32	150	50	11			
AEM90-X012-D32-C32-L250-Z04	●	32	4	32	250	100	11			

R: Sağ / Right / Rechts L: Sol/Left/Links

● Stokta / In Stock / Auf Lager ○ Stokta Yok / Non Stock Item / Kein Lagerartikel, Lieferzeit auf Anfrage

SC Ucuna Uygun. / Compatible with SC Insert. Kompatibel mit SC Wendeplatten.

Sipariş Örneği/Ordering Example/Bestellbeispiel

1 ad./pcs./stück AEM90-XC13-D20-W20-L150-Z02

Kesme Hesabı : S 367 / Cutting Calculation : P 367 / Schnittberechnung : 367



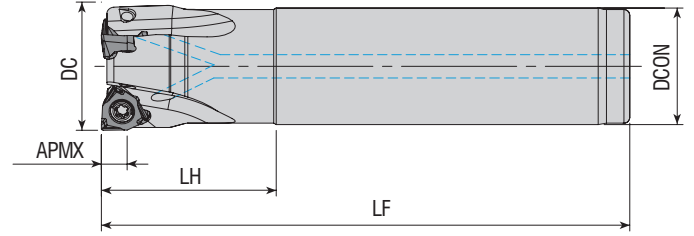

Takım Kodu Ordering Code Bestell-Bezeichnung	Stok Stock Lager	Takım Ölçüleri (mm) Dimension (mm) Abmessung (mm)						Kesici Uç Insert Wendeschneidplatte	Yedek Parçaları / Spare Parts / Ersatzteile	
		DC	ZEFP	DCON	LF	LH	APMX		Sıkma Vidası Screw Schraube	Tork Anahtar Torx Key Torx-Schlüssel
AEM90-XN0403-D16-C16-L100-Z01-H	●	16	1	16	100	30	4			
AEM90-XN0403-D22-C20-L110-Z03-H	●	22	3	20	110	30	4			
AEM90-XN0806-D32-C32-L110-Z02-H	●	32	2	32	110	40	7.5			

SC Ucuna Uygundur. / Compatible with SC Insert. Kompatibel mit SC Wendepplatten.

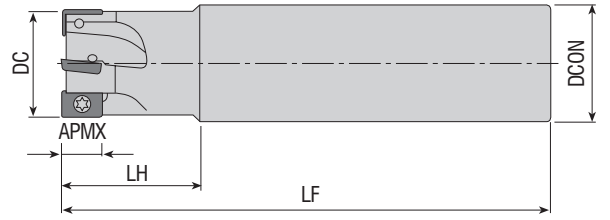

Takım Kodu Ordering Code Bestell-Bezeichnung	Stok Stock Lager	Takım Ölçüleri (mm) Dimension (mm) Abmessung (mm)						Kesici Uç Insert Wendeschneidplatte	Yedek Parçaları / Spare Parts / Ersatzteile	
		DC	ZEFP	DCON	LF	LH	APMX		Sıkma Vidası Screw Schraube	Tork Anahtar Torx Key Torx-Schlüssel
AEM90-ZC1003-D16-C14-L150-Z02	●	16	2	14	150	25	9			
AEM90-ZC1003-D16-C14-L200-Z02	●	16	2	14	200	25	9			
AEM90-ZC1003-D16-C15-L150-Z02	●	16	2	15	150	25	9			
AEM90-ZC1003-D16-C16-L150-Z02	●	16	2	16	150	25	9			
AEM90-ZC1003-D16-C16-L200-Z02	●	16	2	16	200	50	9			
AEM90-ZC1003-D17-C16-L150-Z02	●	17	2	16	150	25	9			
AEM90-ZC1003-D17-C16-L200-Z02	●	17	2	16	200	25	9			
AEM90-ZC1003-D20-C18-L150-Z03	●	20	3	18	150	25	9			
AEM90-ZC1003-D20-C18-L200-Z02	●	20	2	18	200	25	9			
AEM90-ZC1003-D20-C20-L150-Z03	●	20	3	20	150	40	9			
AEM90-ZC1003-D20-C18-L200-Z03	●	20	3	18	200	25	9			
AEM90-ZC1003-D21-C20-L150-Z02	●	21	2	20	150	30	9			
AEM90-ZC1003-D21-C20-L150-Z03	●	21	3	20	150	30	9			
AEM90-ZC1003-D21-C20-L200-Z03	●	21	3	20	200	30	9			
AEM90-ZC1003-D25-C20-L150-Z03	●	25	3	20	150	30	9			
AEM90-ZC1003-D25-C20-L200-Z03	●	25	3	20	200	30	9			
AEM90-ZC1003-D25-C25-L150-Z03	●	25	3	25	150	40	9			
AEM90-ZC1003-D26-C25-L170-Z03	●	26	3	25	170	25	9			
AEM90-ZC1003-D26-C25-L200-Z03	●	26	3	25	200	25	9			
AEM90-ZC1003-D32-C25-L180-Z04	●	32	4	25	180	30	9			
AEM90-ZC1003-D33-C32-L200-Z04	●	33	4	32	200	25	9			

R: Sağ / Right / Rechts L: Sol/Left/Links

● Stokta / In Stock / Auf Lager ○ Stokta Yok / Non Stock Item / Kein Lagerartikel, Lieferzeit auf Anfrage  
DJT Ucuna Uygundur. / Compatible with DJT Insert. Kompatibel mit DJT Wendepplatten.

Sipariş Örneği/Ordering Example/Bestellbeispiel

1 ad./pcs./stück AEM90-XN0403-D16-C16-L100-Z01-H

Kesme Hesabı : S 367 / Cutting Calculation : P 367 / Schnittberechnung : 367

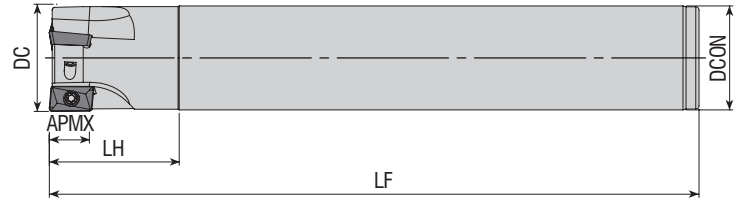

Takım Kodu Ordering Code Bestell-Bezeichnung	Stok Stock Lager	Takım Ölçüleri (mm) Dimension (mm) Abmessung (mm)						Kesici Uç Insert Wendeschneidplatte	Yedek Parçaları / Spare Parts / Ersatzteile		
		DC	ZEFP	DCON	LF	LH	APMX		Sıkma Vidası Screw Schraube	Tork Anahtar Torx Key Torx-Schlüssel	
AEM90-ZP13T3-D26-C25-L200-Z02	●	26	2	25	200	35	13				
AEM90-ZP13T3-D26-C25-L200-Z03	●	26	3	25	200	35	13				
AEM90-ZP13T3-D26-C25-L250-Z02	●	26	2	25	250	35	13				
AEM90-ZP13T3-D33-C32-L200-Z03	●	33	3	32	200	40	13				
AEM90-ZP13T3-D33-C32-L250-Z03	●	33	3	32	250	40	13				

DJT Ucuna Uygun. / Compatible with DJT Insert. Kompatibel mit DJT Wendeschneidplatten.

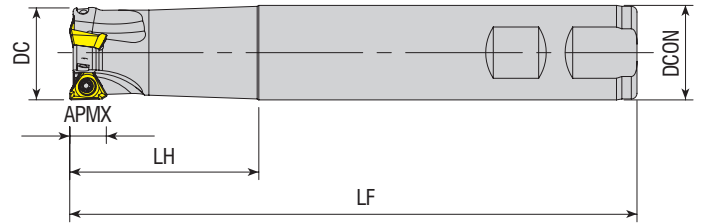

Takım Kodu Ordering Code Bestell-Bezeichnung	Stok Stock Lager	Takım Ölçüleri (mm) Dimension (mm) Abmessung (mm)						Kesici Uç Insert Wendeschneidplatte	Yedek Parçaları / Spare Parts / Ersatzteile		
		DC	ZEFP	DCON	LF	LH	APMX		Sıkma Vidası Screw Schraube	Tork Anahtar Torx Key Torx-Schlüssel	
AEM90-3P0603-D16-W16-L120-Z03-H	●	16	3	16	120	25	4.7				
AEM90-3P0603-D20-W20-L150-Z03-H	●	20	3	20	150	25	4.7				
AEM90-3P0603-D25-W25-L150-Z05-H	●	25	5	25	150	25	4.7				
AEM90-3P1004-D20-W20-L150-Z02	●	20	2	20	150	40	7				
AEM90-3P1004-D21-C20-L200-Z02	●	21	2	20	200	30	7				
AEM90-3P1004-D25-W25-L150-Z03	●	25	3	25	150	40	7				
AEM90-3P1505-D32-W32-L150-Z03	●	32	3	32	150	50	11				
AEM90-3P1505-D38-W32-L150-Z03	●	38	3	32	150	35	11				
AEM90-3P1505-D40-W32-L150-Z04	●	40	4	32	150	35	11				

R: Sağ / Right / Rechts L: Sol/Left/Links

● Stokta / In Stock / Auf Lager ○ Stokta Yok / Non Stock Item / Kein Lagerartikel, Lieferzeit auf Anfrage

TGTC Ucuna Uygun. / Compatible with TGTC Insert. Kompatibel mit TGTC Wendeschneidplatten.

Sipariş Örneği/Ordering Example/Bestellbeispiel

1 ad./pcs./stück AEM90-ZP13T3-D26-C25-L200-Z02

Kesme Hesabı : S 367 / Cutting Calculation : P 367 / Schnittberechnung : 367

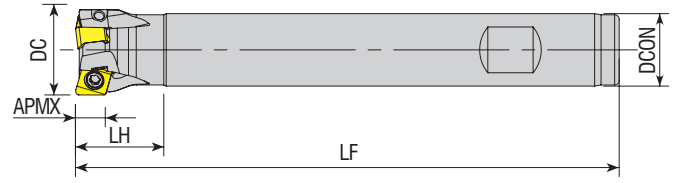

Takım Kodu Ordering Code Bestell-Bezeichnung	Stok Stock Lager	Takım Ölçüleri (mm) Dimension (mm) Abmessung (mm)						Kesici Uç Insert Wendeschneidplatte	Yedek Parçaları / Spare Parts / Ersatzteile		
		DC	ZEFP	DCON	LF	LH	APMX		Sıkma Vidası Screw Schraube	Baskı Parçası Wedge Clamp Spannpratze	Baskı Vidası Clamp Screw Klemmschraube
AEM90-4N06-D16-W16-L120-Z02-H	●	16	2	16	120	25	6	4NKT 0603..	1108-M3x6.8	80-T08	
AEM90-4N06-D16-W16-L160-Z02	●	16	2	16	160	25	6				
AEM90-4N06-D20-W16-L120-Z03-H	●	20	3	16	120	20	6				
AEM90-4N06-D20-W16-L160-Z03	●	20	3	16	160	20	6				

TGTC Ucuna Uygundur. / Compatible with TGTC Insert. Kompatibel mit TGTC Wendeplatten.

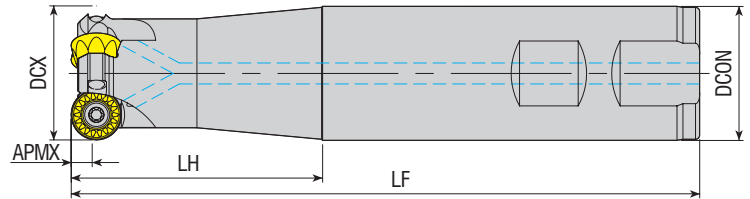

Takım Kodu Ordering Code Bestell-Bezeichnung	Stok Stock Lager	Takım Ölçüleri (mm) Dimension (mm) Abmessung (mm)						Kesici Uç Insert Wendeschneidplatte	Yedek Parçaları / Spare Parts / Ersatzteile			
		DCX	ZEFP	DCON	LF	LH	APMX		Sıkma Vidası Screw Schraube	Baskı Parçası Wedge Clamp Spannpratze	Baskı Vidası Clamp Screw Klemmschraube	Tork Anahtar Torx Key Torx-Schlüssel
AEMR-RP08T2M-D20-W20-L150-Z02-H	●	20	2	20	150	60	4	RPMT 08T2..	3008-M2.5x6	-	-	80-T08
AEMR-RP08T2M-D25-W25-L200-Z03-H	●	25	3	25	200	100	4					
AEMR-RP10T3M-D25-W25-L200-Z02-H	●	25	2	25	200	100	5	RPMT 10T3..	4015-M3.5x9	-	-	80-T15
AEMR-RP10T3M-D32-W32-L200-Z03-H	●	32	3	32	200	100	5					
AEMR-RP1204M-D32-W32-L150-Z03-H	●	32	3	32	150	60	6	RPMT 1204..	4015-M4x9	-	-	80-T15
AEMR-RP1204M-D32-W32-L200-Z03-H	●	32	3	32	200	100	6					
AEMR-RP1606M-D40-W32-L150-Z02-H	●	40	2	16	150	35	8	RPMT 1606..	1020-M5x11	-	-	80-T20
AEMR-RP1606M-D40-W32-L200-Z02-H	●	40	2	16	200	35	8					

R: Sağ / Right / Rechts L: Sol/Left/Links

● Stokta / In Stock / Auf Lager ○ Stokta Yok / Non Stock Item / Kein Lagerartikel, Lieferzeit auf Anfrage  
MTSBSH Ucuna Uygundur. / Compatible with MTSBSH Insert. Kompatibel mit MTSBSH Wendeplatten.

Sipariş Örneği/Ordering Example/Bestellbeispiel  
1 ad./pcs./stück AEM90-4N06-D16-W16-L120-Z02-H  
Kesme Hesabı : S 367 / Cutting Calculation : P 367 / Schnittberechnung : 367

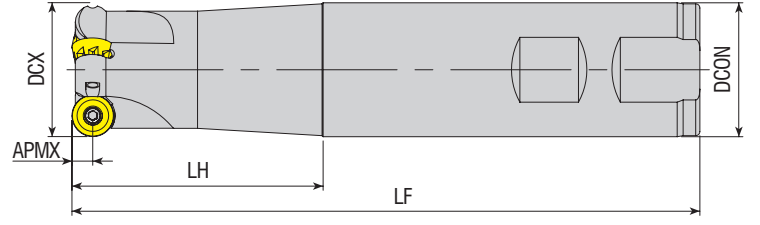

Takım Kodu Ordering Code Bestell-Bezeichnung	Stok Stock Lager	Takım Ölçüleri (mm) Dimension (mm) Abmessung (mm)						Kesici Uç Insert Wendeschneidplatte	Yedek Parçaları / Spare Parts / Ersatzteile			
		DCX	ZEP	DCON	LF	LH	APMX		Sıkma Vidası Screw Schraube	Baskı Parçası Wedge Clamp Spannpratze	Baskı Vidası Clamp Screw Klemmschraube	Tork Anahtar Torx Key Torx-Schlüssel
AEMR-RP10T3-D25-W25-L125-Z02	●	25	2	25	125	60	5	RPNX 10T3..	4010-M3x8	-	-	80-T10
AEMR-RP10T3-D25-W25-L150-Z02	●	25	2	25	150	60	5					
AEMR-RP10T3-D32-W32-L150-Z03	●	32	3	32	150	60	5					

CRTZT Ucuna Uygunur. / Compatible with CRTZT Insert. Kompatibel mit CRTZT Wendeplatten.

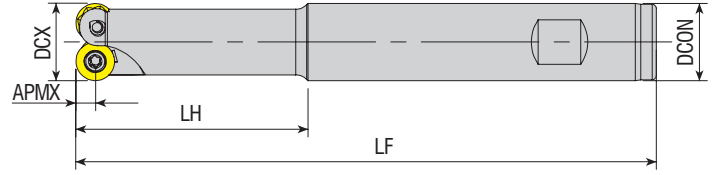

Takım Kodu Ordering Code Bestell-Bezeichnung	Stok Stock Lager	Takım Ölçüleri (mm) Dimension (mm) Abmessung (mm)						Kesici Uç Insert Wendeschneidplatte	Yedek Parçaları / Spare Parts / Ersatzteile		
		DCX	ZEP	DCON	LF	LH	APMX		Sıkma Vidası Screw Schraube	Tork Anahtar Torx Key Torx-Schlüssel	
AEMR-RY08-D16-W16-L150-Z02	●	16	2	16	150	55	4	RYMX 0803..	4010-M3x6	80-T10	
AEMR-RY10-D20-W20-L150-Z02	●	20	2	20	150	60	5	RYMX 1004..	4015-M3.5x8	80-T15	
AEMR-RY10-D20-C20-L200-Z02	●	20	2	20	200	100	5				
AEMR-RY10-D21-W20-L200-Z02-H	●	21	2	20	200	30	5				
AEMR-RY10-D25-W25-L150-Z02	●	25	2	25	150	60	5				
AEMR-RY10-D26-W25-L200-Z02-H	●	26	2	25	200	60	5				
AEMR-RY10-D32-W32-L160-Z04-H	●	32	4	32	160	60	5				
AEMR-RY12-D32-C25-L160-Z03	●	32	3	25	160	30	6				RYMX 1205..

R: Sağ / Right / Rechts L: Sol/Left/Links

● Stokta / In Stock / Auf Lager ○ Stokta Yok / Non Stock Item / Kein Lagerartikel, Lieferzeit auf Anfrage

TGTC Ucuna Uygunur. / Compatible with TGTC Insert. Kompatibel mit TGTC Wendeplatten.

Sipariş Örneği/Ordering Example/Bestellbeispiel

1 ad./pcs./stück AEMR-RP10T3-D25-W25-L125-Z02

Kesme Hesabı : S 367 / Cutting Calculation : P 367 / Schnittberechnung : 367



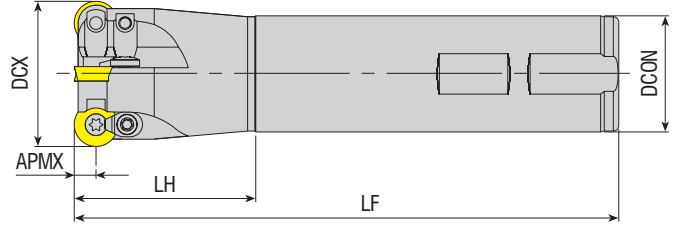

**Takım Kodu**  
**Ordering Code**  
*Bestell-Bezeichnung*

Stok Stock Lager	Takım Ölçüleri (mm) Dimension (mm) Abmessung (mm)							Kesici Uç Insert Wendeschneidplatte	Yedek Parçaları / Spare Parts / Ersatzteile				Tork Anahtar Torx Key Torx-Schlüssel			
	DCX	ZEFP	DCON	LF	LH	APMX	Sıkma Vidası Screw Schraube		Baskı Parçası Wedge Clamp Spannpratze	Baskı Vidası Clamp Screw Klemmschraube						
●	8	1	10	100	20	2.5	RD.. 0501	3006-M2x3.6	-	-	80-T06					
●	10	2	12	100	20	2.5										
●	12	2	12	120	20	2.5										
●	16	2	16	150	60	4	RD.. 0803	3008-M3x6	-	-	80-T08					
●	16	2	20	200	60	4										
●	20	3	20	150	60	4										
●	16	2	16	150	60	4	RD.. 08T2	3008-M2.5x6	-	-	80-T08					
●	20	2	20	150	60	4										
●	20	2	20	150	60	5	RD.. 1003	-	-	-	-					
●	20	2	20	160	70	5										
●	20	2	20	250	150	5										
●	21	2	20	160	70	5										
●	25	2	25	150	60	5										
●	25	2	25	160	70	5										
●	25	2	25	200	100	5										
●	25	2	25	200	100	5										
●	25	2	25	250	150	5										
●	26	2	25	160	70	5										
●	32	3	32	150	60	5										
●	32	2	32	250	150	5										
●	33	3	32	160	70	5										
●	40	4	32	150	35	5										
●	40	2	32	250	50	5										
●	20	2	20	150	60	5						RD.. 10T3	4015-M3.5x9	ACK-15	4015-M3.5x11	80-T15
●	20	2	20	150	60	5										
●	25	2	25	150	60	5										
●	25	2	25	200	100	5										
●	25	2	25	150	60	5										
●	32	3	25	250	35	5										
●	32	3	32	150	60	5	RD.. 12T3	-	-	-	-					
●	25	2	25	150	60	6										
●	25	2	25	200	100	6										
●	25	2	25	250	150	6										
●	25	2	25	300	200	6										
●	32	3	32	150	60	6										
●	32	2	32	250	150	6										
●	40	4	32	150	50	6										
●	40	2	32	250	50	6	RD.. 1204	-	-	-	-					
●	32	3	32	160	70	6										
●	32	3	32	160	70	6										
●	33	3	32	160	70	6	RD.. 1604	4015-M4.5x11	ACK-05	4015-M4x11	-					
●	40	2	32	150	35	8										

R: Sağ / Right / Rechts L: Sol/Left/Links

● Stokta / In Stock / Auf Lager ○ Stokta Yok / Non Stock Item / Kein Lagerartikel, Lieferzeit auf Anfrage  
ISO Ucuna Uygunudur. / Compatible with ISO Insert. Kompatibel mit ISO Wendeplatten.

Sipariş Örneği/Ordering Example/Bestellbeispiel

1 ad./pcs./stück AEMR-RD0501-D08-W10-L100-Z01-H

Kesme Hesabı : S 367 / Cutting Calculation : P 367 / Schnittberechnung : 367

**S-SİSTEM YÜZEY ve KOPYA PARMAK FREZELER**  
**S-SYSTEM FACE and COPY END MILLS**  
**S-SYSTEM KOPIER- UND SCHAFTFRÄSER**

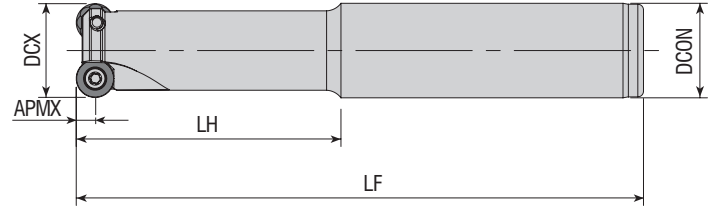

Takım Kodu Ordering Code Bestell-Bezeichnung	Stok Stock Lager	Takım Ölçüleri (mm) Dimension (mm) Abmessung (mm)						Kesici Uç Insert Wendeschneidplatte	Yedek Parçaları / Spare Parts / Ersatzteile			
		DCX	ZEP	DCON	LF	LH	APMX		Sıkma Vidası Screw Schraube	Baskı Parçası Wedge Clamp Spannpratze	Baskı Vidası Clamp Screw Klemmschraube	Tork Anahtar Torx Key Torx-Schlüssel
AEMR-QP10T3-D20-C20-L150-Z01-H	●	20	1	20	150	70	5	QP. 10T3..	4015-M3.5x9	-	-	80-T15
AEMR-QP10T3-D25-C25-L120-Z02-H	●	25	2	25	120	40	5					
AEMR-QP10T3-D25-C25-L150-Z02-H	●	25	2	25	150	70	5					
AEMR-QP10T3-D25-C25-L170-Z02	●	25	2	25	170	90	5					
AEMR-QP10T3-D32-C32-L150-Z03-H	●	32	3	32	150	70	5					
AEMR-QP10T3-D32-C32-L170-Z03	●	32	3	32	170	90	5					
AEMR-QP1204-D25-C25-L150-Z02-H	●	25	2	25	150	70	6	QP. 1204..	4015-M4x9	-	-	

SMTM Ucuna Uygun. / Compatiple with SMTM Insert. Kompatibel mit SMTM Wendeplatten.

**S-SİSTEM HIZLI İLERLEMELİ PARMAK FREZELER**  
**S-SYSTEM HIGHFEED END MILLS**  
**S-SYSTEM HOCHVORSCHUB- SCHAFTFRÄSER**

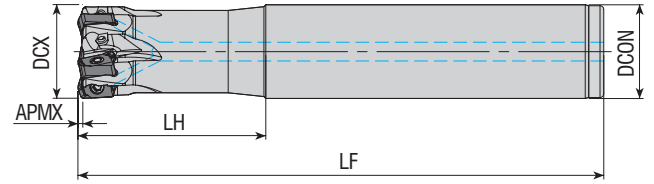

Takım Kodu Ordering Code Bestell-Bezeichnung	Stok Stock Lager	Takım Ölçüleri (mm) Dimension (mm) Abmessung (mm)						Kesici Uç Insert Wendeschneidplatte	Yedek Parçaları / Spare Parts / Ersatzteile	
		DCX	ZEP	DCON	LF	LH	APMX		Sıkma Vidası Screw Schraube	Tork Anahtar Torx Key Torx-Schlüssel
AHFM-BN10T3-D16-C16-L100-Z02-H	●	16	2	16	100	30	1	BNGX 10T3..	3008-M2.5x6	80-T08
AHFM-BN10T3-D16-C16-L150-Z02-H	●	16	2	16	150	50	1			
AHFM-BN10T3-D20-C20-L130-Z03-H	●	20	3	20	130	40	1			
AHFM-BN10T3-D20-C20-L130-Z04-H	●	20	4	20	130	40	1			
AHFM-BN10T3-D20-C20-L160-Z03-H	●	20	3	20	160	80	1			
AHFM-BN10T3-D25-C25-L140-Z04-H	●	25	4	25	140	50	1			
AHFM-BN10T3-D25-W25-L140-Z04-H	●	25	4	25	140	50	1			
AHFM-BN10T3-D25-C25-L140-Z05-H	●	25	5	25	140	50	1			
AHFM-BN10T3-D25-C25-L180-Z04-H	●	25	4	25	180	100	1			
AHFM-BN10T3-D32-C32-L150-Z05-H	●	32	5	32	150	70	1			
AHFM-BN10T3-D32-C32-L150-Z06-H	●	32	6	32	150	70	1			
AHFM-BN10T3-D35-C32-L200-Z06-H	●	35	6	32	200	50	1			

R: Sağ / Right / Rechts L: Sol/Left/Links

● Stokta / In Stock / Auf Lager ○ Stokta Yok / Non Stock Item / Kein Lagerartikel, Lieferzeit auf Anfrage

PRMT Ucuna Uygun. / Compatiple with PRMT Insert. Kompatibel mit PRMT Wendeplatten.



Sipariş Örneği/Ordering Example/Bestellbeispiel

1 ad./pcs./stück AEMR-QP10T3-D20-C20-L150-Z01-H

Kesme Hesabı : S 367 / Cutting Calculation : P 367 / Schnittberechnung : 367

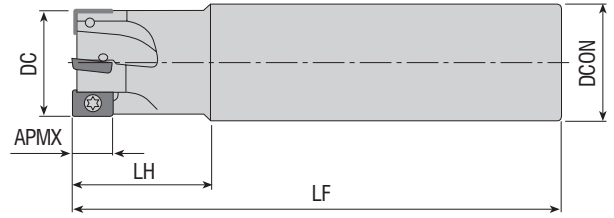



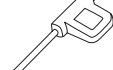

Takım Kodu Ordering Code Bestell-Bezeichnung	Stok Stock Lager	Takım Ölçüleri (mm) Dimension (mm) Abmessung (mm)						Kesici Uç Insert Wendeschneidplatte	Yedek Parçaları / Spare Parts / Ersatzteile		
		DC	ZEFP	DCON	LF	LH	APMX		Sıkma Vidası Screw Schraube	Tork Anahtar Torx Key Torx-Schlüssel	
AHFM-E00602-D10-C10-L080-Z02	●	10	2	10	80	20	-	 <b>EO.. 0602..</b> <b>ZOMT 0602..</b>	 3006-M1.8x4	 80-T06	
AHFM-E00602-D10-C09-L120-Z02	●	10	2	9	120	15	-				
AHFM-E00602-D10-C10-L120-Z02	●	10	2	10	120	60	-				
AHFM-E00602-D12-C12-L080-Z02	●	12	2	12	80	20	-				
AHFM-E00602-D12-C12-L080-Z03	●	12	3	12	80	20	-				
AHFM-E00602-D12-C11-L120-Z02	●	12	2	11	120	15	-				
AHFM-E00602-D12-C11-L120-Z03	●	12	3	11	120	15	-				
AHFM-E00602-D12-C12-L120-Z02	●	12	2	12	120	60	-				
AHFM-E00602-D12-C12-L120-Z03	●	12	3	12	120	60	-				
AHFM-E00602-D16-C16-L150-Z04	●	16	4	16	150	60	-				

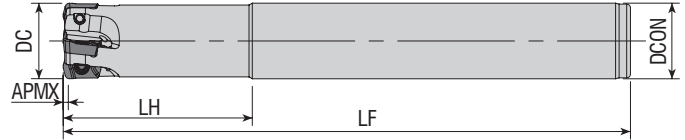
DJT Ucuna Uygunudur. / Compatible with DJT Insert. Kompatibel mit DJT Wendepplatten.



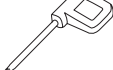

Takım Kodu Ordering Code Bestell-Bezeichnung	Stok Stock Lager	Takım Ölçüleri (mm) Dimension (mm) Abmessung (mm)						Kesici Uç Insert Wendeschneidplatte	Yedek Parçaları / Spare Parts / Ersatzteile		
		DC	ZEFP	DCON	LF	LH	APMX		Sıkma Vidası Screw Schraube	Tork Anahtar Torx Key Torx-Schlüssel	
AHFM-EP1003-D16-C16-L150-Z02-H	●	16	2	16	150	50	1	 <b>EP. 1003..</b> <b>ZPMT 1003..</b> <b>YPHW 1003..</b>	 3008-M2.5x5	 80-T08	
AHFM-EP1003-D17-C16-L150-Z02-H	●	17	2	16	150	20	1				
AHFM-EP1003-D20-C20-L150-Z04-H	●	20	4	20	150	50	1				
AHFM-EP1003-D21-C20-L150-Z04-H	●	21	4	20	150	20	1				
AHFM-EP1003-D25-C25-L200-Z04-H	●	25	4	25	200	100	1				
AHFM-EP1003-D25-C25-L250-Z04-H	●	25	4	25	250	100	1				

R: Sağ / Right / Rechts L: Sol/Left/Links

● Stokta / In Stock / Auf Lager ○ Stokta Yok / Non Stock Item / Kein Lagerartikel, Lieferzeit auf Anfrage  
DJT Ucuna Uygunudur. / Compatible with DJT Insert. Kompatibel mit DJT Wendepplatten.

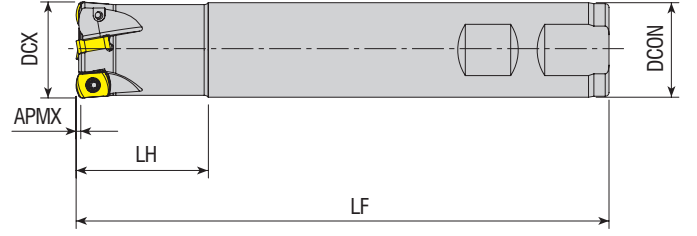
Sipariş Örneği/Ordering Example/Bestellbeispiel  
1 ad./pcs./stück AHFM-E00602-D10-C10-L080-Z02  
Kesme Hesabı : S 367 / Cutting Calculation : P 367 / Schnittberechnung : 367

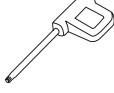

Takım Kodu Ordering Code Bestell-Bezeichnung	Stok Stock Lager	Takım Ölçüleri (mm) Dimension (mm) Abmessung (mm)						Kesici Uç Insert Wendeschneidplatte	Yedek Parçaları / Spare Parts / Ersatzteile		
		DCX	ZEFP	DCON	LF	LH	APMX		Sıkma Vidası Screw Schraube	Tork Anahtar Torx Key Torx-Schlüssel	
AHFM-BL0603-D16-C15-L150-Z02	●	16	2	15	150	20	1				
AHFM-BL0603-D16-C16-L100-Z02-H	●	16	2	16	100	30	1				
AHFM-BL0603-D16-C16-L150-Z02	●	16	2	16	150	50	1				
AHFM-BL0603-D17-C16-L150-Z02	●	17	2	16	150	20	1				
AHFM-BL0603-D17-W16-L170-Z02	●	17	2	16	170	20	1				
AHFM-BL0603-D17-W16-L170-Z02-H	●	17	2	16	170	20	1				
AHFM-BL0603-D17-C16-L200-Z02	●	17	2	16	200	30	1				
AHFM-BL0603-D18-C16-L150-Z02	●	18	2	16	150	20	1				
AHFM-BL0603-D18-W16-L150-Z02-H	●	18	2	16	150	20	1				
AHFM-BL0603-D20-C20-L130-Z03	●	20	3	20	130	50	1				
AHFM-BL0603-D20-C20-L160-Z03	●	20	3	20	160	50	1				
AHFM-BL0603-D21-C20-L200-Z03	●	21	3	20	200	25	1				
AHFM-BL0603-D21-W20-L200-Z03	●	21	3	20	200	25	1				
AHFM-BL0603-D22-W20-L150-Z03	●	22	3	20	150	20	1				
AHFM-BL0603-D25-C25-L250-Z04	●	25	4	25	250	40	1				
AHFM-BL0603-D26-C25-L200-Z04	●	26	4	25	200	35	1				
AHFM-BL0603-D26-W25-L200-Z04	●	26	4	25	200	35	1				
AHFM-BL0603-D26-C25-L250-Z04	●	26	4	25	250	35	1				
AHFM-BL0603-D32-C32-L150-Z05	●	32	5	32	150	70	1				
AHFM-BL0603-D32-C32-L200-Z05	●	32	5	32	200	120	1				
AHFM-BL0603-D33-C32-L150-Z05	●	33	5	32	150	40	1				
AHFM-BL0603-D33-C32-L200-Z05	●	33	5	32	200	40	1				
AHFM-BL0603-D33-C32-L250-Z05	●	33	5	32	250	40	1				

R: Sağ / Right / Rechts L: Sol/Left/Links  
● Stokta / In Stock / Auf Lager ○ Stokta Yok / Non Stock Item / Kein Lagerartikel, Lieferzeit auf Anfrage  
TGTC Uçuna Uygun. / Compatible with TGTC Insert. Kompatibel mit TGTC Wendeplatten.

Sipariş Örneği/Ordering Example/Bestellbeispiel  
1 ad./pcs./stück AHFM-BL0603-D16-C15-L150-Z02  
Kesme Hesabı : S 367 / Cutting Calculation : P 367 / Schnittberechnung : 367



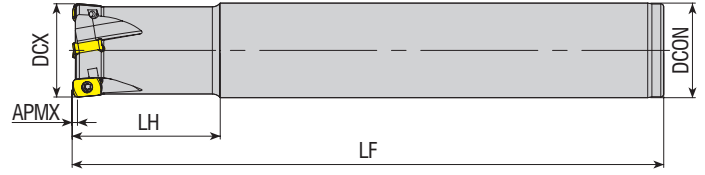

Takım Kodu Ordering Code Bestell-Bezeichnung	Stok Stock Lager	Takım Ölçüleri (mm) Dimension (mm) Abmessung (mm)						Kesici Uç Insert Wendeschneidplatte	Yedek Parçaları / Spare Parts / Ersatzteile			
		DCX	ZEPF	DCON	LF	LH	APMX		Sıkma Vidası Screw Schraube	Tork Anahtar Torx Key Torx-Schlüssel		
AHFM-EN1004-D16-C15-L150-Z02	●	16	2	15	150	25	1	ENMU 1004..	3008-M2.5x5	80-T08		
AHFM-EN1004-D16-C16-L150-Z02	●	16	2	16	150	25	1					
AHFM-EN1004-D16-C16-L250-Z02	●	16	2	16	250	70	1					
AHFM-EN1004-D17-C16-L150-Z02-H	●	17	2	16	150	25	1					
AHFM-EN1004-D17-C16-L150-Z02	●	17	2	16	150	25	1					
AHFM-EN1004-D17-C16-L200-Z02	●	17	2	16	200	25	1					
AHFM-EN1004-D18-C16-L150-Z02	●	18	2	16	150	25	1					
AHFM-EN1004-D20-C20-L150-Z03	●	20	3	20	150	40	1					
AHFM-EN1004-D20-C20-L250-Z03	●	20	3	20	250	70	1					
AHFM-EN1004-D21-C20-L150-Z02	●	21	2	20	150	30	1					
AHFM-EN1004-D21-C20-L150-Z03	●	21	3	20	150	30	1					
AHFM-EN1004-D21-C20-L150-Z03-H	●	21	3	20	150	30	1					
AHFM-EN1004-D21-C20-L200-Z03	●	21	3	20	200	30	1					
AHFM-EN1004-D22-C20-L150-Z03	●	22	3	20	150	30	1					
AHFM-EN1004-D25-C25-L150-Z03	●	25	3	25	150	40	1					
AHFM-EN1004-D25-C25-L150-Z04	●	25	4	25	150	40	1					
AHFM-EN1004-D26-C25-L150-Z03	●	26	3	25	150	30	1					
AHFM-EN1004-D26-C25-L150-Z04	●	26	4	25	150	30	1					
AHFM-EN1004-D26-C25-L200-Z03	●	26	3	25	150	30	1					
AHFM-EN1004-D26-C25-L200-Z03-H	●	26	3	25	200	30	1					
AHFM-EN1004-D26-C25-L250-Z03-H	●	26	3	25	250	30	1					
AHFM-EN1004-D28-C25-L200-Z04	●	28	4	25	200	30	1					
AHFM-EN1004-D32-C32-L200-Z04	●	32	4	32	200	50	1					
AHFM-EN1004-D33-C32-L200-Z04	●	33	4	32	200	30	1					
AHFM-EN1004-D33-C32-L200-Z04-H	●	33	4	32	200	30	1					
											3008-M2.5x6	

R: Sağ / Right / Rechts L: Sol/Left/Links  
● Stokta / In Stock / Auf Lager ○ Stokta Yok / Non Stock Item / Kein Lagerartikel, Lieferzeit auf Anfrage  
DJT Ucuna Uygunudur. / Compatible with DJT Insert. Kompatibel mit DJT Wendeplatten.

Sipariş Örneği/Ordering Example/Bestellbeispiel  
1 ad./pcs./stück AHFM-EN1004-D16-C15-L150-Z02  
Kesme Hesabı : S 367 / Cutting Calculation : P 367 / Schnittberechnung : 367



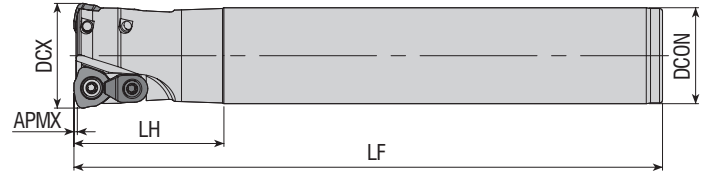

Takım Kodu Ordering Code Bestell-Bezeichnung	Stok Stock Lager	Takım Ölçüleri (mm) Dimension (mm) Abmessung (mm)						Kesici Uç Insert Wendeschneidplatte	Yedek Parçaları / Spare Parts / Ersatzteile			
		DCX	ZEP	DCON	LF	LH	APMX		Sıkma Vidası Screw Schraube	Baskı Parçası Wedge Clamp Spannpratze	Baskı Vidası Clamp Screw Klemmschraube	Tork Anahtar Torx Key Torx-Schlüssel
AHFMC-JD1204-D32-C32-L150-Z02	●	32	2	32	150	50	1	JDMW 1204..	4615-M4x11	ACK-05	4015-M4x11	80-T15
AHFMC-JD1204-D32-C32-L200-Z02	●	32	2	32	200	50	1					
AHFMC-JD1204-D35-C32-L200-Z02	●	35	2	32	200	50	1					
AHFMC-JD1204-D35-C32-L250-Z02	●	35	2	32	250	50	1					

MTSBH Ucuna Uygun. / Compatiple with MTSBHInsert. Kompatibel mit MTSBH Wendeplatten.

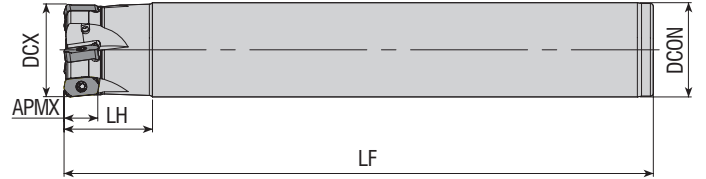

Takım Kodu Ordering Code Bestell-Bezeichnung	Stok Stock Lager	Takım Ölçüleri (mm) Dimension (mm) Abmessung (mm)						Kesici Uç Insert Wendeschneidplatte	Yedek Parçaları / Spare Parts / Ersatzteile	
		DCX	ZEP	DCON	LF	LH	APMX		Sıkma Vidası Screw Schraube	Tork Anahtar Torx Key Torx-Schlüssel
AHFM-LN0303-D16-C15-L150-Z02	●	16	2	15	150	30	12	LNMU 0303..	3008-M2.5x6	80-T08
AHFM-LN0303-D16-W16-L150-Z02-H	●	16	2	16	150	50	12			
AHFM-LN0303-D20-W20-L150-Z03-H	●	20	3	20	150	50	12			
AHFM-LN0303-D21-C20-L150-Z03	●	21	3	20	150	30	12			
AHFM-LN0303-D25-W25-L150-Z04-H	●	25	4	25	150	50	12			
AHFM-LN0303-D26-C25-L150-Z04	●	26	4	25	150	30	12			
AHFM-LN0303-D33-C32-L200-Z05	●	33	5	32	200	30	12			

R: Sağ / Right / Rechts L: Sol/Left/Links

● Stokta / In Stock / Auf Lager ○ Stokta Yok / Non Stock Item / Kein Lagerartikel, Lieferzeit auf Anfrage

TNGYL Ucuna Uygun. / Compatiple with TNGYL Insert. Kompatibel mit TNGYL Wendeplatten.

Sipariş Örneği/Ordering Example/Bestellbeispiel

1 ad./pcs./stück AHFMC-JD1204-D32-C32-L150-Z02

Kesme Hesabı : S 367 / Cutting Calculation : P 367 / Schnittberechnung : 367

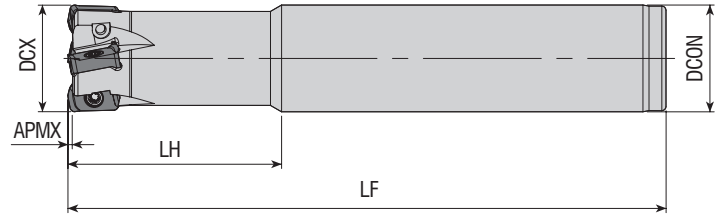



Takım Kodu Ordering Code Bestell-Bezeichnung	Stok Stock Lager	Takım Ölçüleri (mm) Dimension (mm) Abmessung (mm)						Kesici Uç Insert Wendeschneidplatte	Yedek Parçaları / Spare Parts / Ersatzteile		
		DCX	ZEFP	DCON	LF	LH	APMX		Sıkma Vidası Screw Schraube	Tork Anahtar Torx Key Torx-Schlüssel	
AHFM-L003-D16-C15-L160-Z02	●	16	2	15	160	30	1	LOGU 0303..	1108-M3x6.8	80-T08	
AHFM-L003-D16-C16-L100-Z02-F	●	16	2	16	100	30	1				
AHFM-L003-D16-C16-L100-Z02	●	16	2	16	100	30	1				
AHFM-L003-D16-C16-L130-Z02-H	●	16	2	16	130	40	1				
AHFM-L003-D16-C16-L160-Z02	●	16	2	16	160	50	1				
AHFM-L003-D16-C16-L160-Z02-H	●	16	2	16	160	100	1				
AHFM-L003-D17-C16-L180-Z02	●	17	2	16	180	30	1				
AHFM-L003-D20-C20-L130-Z03	●	20	3	20	130	40	1				
AHFM-L003-D20-C20-L130-Z03-H	●	20	3	20	130	40	1				
AHFM-L003-D20-C20-L160-Z03	●	20	3	20	160	80	1				
AHFM-L003-D20-C20-L160-Z03-H	●	20	3	20	160	100	1				
AHFM-L003-D21-C20-L150-Z03-H	●	21	3	20	150	30	1				
AHFM-L003-D21-C20-L200-Z03	●	21	3	20	200	30	1				
AHFM-L003-D21-C20-L200-Z03-H	●	21	3	20	200	30	1				
AHFM-L003-D25-C25-L140-Z04-F	●	25	4	25	140	50	1				
AHFM-L003-D25-C25-L140-Z04	●	25	4	25	140	50	1				
AHFM-L003-D25-C25-L180-Z04	●	25	4	25	180	100	1				
AHFM-L003-D26-C25-L250-Z04	●	26	4	25	250	40	1				
AHFM-L003-D32-C32-L200-Z05	●	32	5	32	200	120	1				
AHFM-L003-D33-C32-L250-Z05	●	33	5	32	250	40	1				

R: Sağ / Right / Rechts L: Sol/Left/Links  
 ● Stokta / In Stock / Auf Lager ○ Stokta Yok / Non Stock Item / Kein Lagerartikel, Lieferzeit auf Anfrage  
 KYCR Ucuna Uygundur. / Compatible with KYCR Insert. Kompatibel mit KYCR Wendepplatten.  
 F: Eksenel ve Radyal Salgı Değeri 0,02 mm içindedir. / F: Axial and Radial Runout Value is within 0,02 mm.  
 F: Der axiale und radiale Rundlaufwert liegt innerhalb von 0,02 mm.

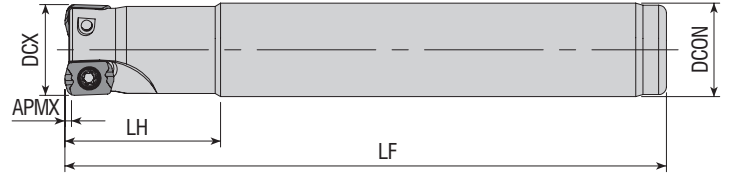



Sipariş Örneği/Ordering Example/Bestellbeispiel  
 1 ad./pcs./stück AHFM-L003-D16-C15-L160-Z02  
 Kesme Hesabı : S 367 / Cutting Calculation : P 367 / Schnittberechnung : 367

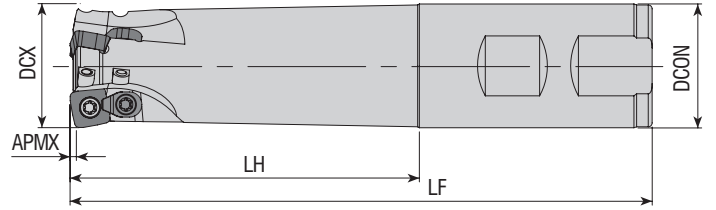

Takım Kodu Ordering Code Bestell-Bezeichnung	Stok Stock Lager	Takım Ölçüleri (mm) Dimension (mm) Abmessung (mm)						Kesici Uç Insert Wendeschneidplatte	Yedek Parçaları / Spare Parts / Ersatzteile		
		DCX	ZEFP	DCON	LF	LH	APMX		Sıkma Vidası Screw Schraube	Tork Anahtar Torx Key Torx-Schlüssel	
AHFM-LP0102-D10-C09-L120-Z02	●	10	2	9	120	20	0.5	LPGT 0102..			
AHFM-LP0102-D10-C10-L120-Z02	●	10	2	10	120	20	0.5				
AHFM-LP0102-D12-C11-L120-Z02	●	12	2	11	120	20	0.5				
AHFM-LP0102-D12-C12-L120-Z02	●	12	2	12	120	20	0.5				

KYCR Ucuna Uygunur. / Compatible with KYCR Insert. Kompatibel mit KYCR Wendepfatten.



Takım Kodu Ordering Code Bestell-Bezeichnung	Stok Stock Lager	Takım Ölçüleri (mm) Dimension (mm) Abmessung (mm)						Kesici Uç Insert Wendeschneidplatte	Yedek Parçaları / Spare Parts / Ersatzteile			
		DCX	ZEFP	DCON	LF	LH	APMX		Sıkma Vidası Screw Schraube	Baskı Parçası Wedge Clamp Spannpratze	Baskı Vidası Clamp Screw Klemmschraube	Tork Anahtar Torx Key Torx-Schlüssel
AHFM-SD06T2-D16-C16-L100-Z02-H	●	16	2	16	100	50	0.8	SD.. 06T2..				
AHFM-SD06T2-D16-C16-L150-Z02-H	●	16	2	16	150	50	0.8					
AHFM-SD06T2-D16-C16-L200-Z02	●	16	2	16	200	100	0.8					
AHFM-SD06T2-D17-C16-L150-Z02-H	●	17	2	16	150	50	0.8					
AHFM-SD06T2-D20-C20-L150-Z03-H	●	20	3	20	150	50	0.8					
AHFM-SD06T2-D20-C20-L200-Z03	●	20	3	20	200	100	0.8					
AHFM-SD06T2-D21-C20-L150-Z03-H	●	21	3	20	150	50	0.8					
AHFM-SD06T2-D25-C25-L150-Z04-H	●	25	4	25	150	60	0.8					
AHFM-SD06T2-D26-C25-L150-Z04-H	●	26	4	25	150	60	0.8					
AHFM-SD06T2-D22-W20-L150-Z02	●	22	2	20	150	30	1.4					
AHFM-SD09T3-D25-C25-L150-Z02	●	25	2	25	150	94	1.4					
AHFM-SD09T3-D25-W25-L150-Z02	●	25	2	25	150	94	1.4					
AHFM-SD09T3-D28-C25-L150-Z02	●	28	2	25	150	30	1.4					
AHFM-SD09T3-D32-C32-L150-Z03	●	32	3	32	150	100	1.4					
AHFM-SD09T3-D32-W32-L150-Z03	●	32	3	32	150	90	1.4					
AHFM-SD09T3-D25-C25-L150-Z03	●	25	3	25	150	60	1.4					
AHFM-SD09T3-D32-C32-L150-Z04	●	32	4	25	150	60	1.4					

R: Sağ / Right / Rechts L: Sol/Left/Links

● Stokta / In Stock / Auf Lager ○ Stokta Yok / Non Stock Item / Kein Lagerartikel, Lieferzeit auf Anfrage

ZCC Ucuna Uygunur. / Compatible with ZCC Insert. Kompatibel mit ZCC Wendepfatten.

Sipariş Örneği/Ordering Example/Bestellbeispiel

1 ad./pcs./stück AHFM-LP0102-D10-C09-L120-Z02

Kesme Hesabı : S 367 / Cutting Calculation : P 367 / Schnittberechnung : 367



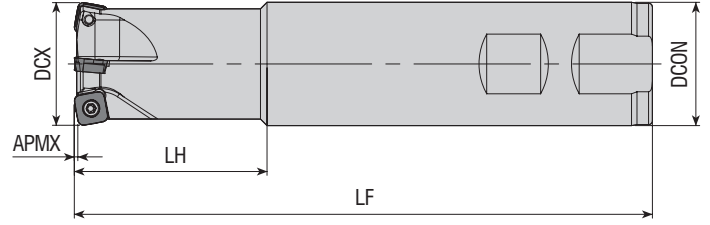

Takım Kodu Ordering Code Bestell-Bezeichnung	Stok Stock Lager	Takım Ölçüleri (mm) Dimension (mm) Abmessung (mm)						Kesici Uç Insert Wendeschneidplatte	Yedek Parçaları / Spare Parts / Ersatzteile		
		DCX	ZEFP	DCON	LF	LH	APMX		Sıkma Vidası Screw Schraube	Tork Anahtar Torx Key Torx-Schlüssel	
AHFM-S00803-D20-W20-L150-Z02	●	20	2	20	150	50	-	SOMW 0803..		4010-M3x8	
AHFM-S00803-D25-W25-L150-Z03	●	25	3	25	150	50	-				
AHFM-S00803-D32-W32-L150-Z04	●	32	4	32	150	50	-				

KPTK Ucuna Uygun. / Compatible with KPTK Insert. Kompatibel mit KPTK Wendeplatten.

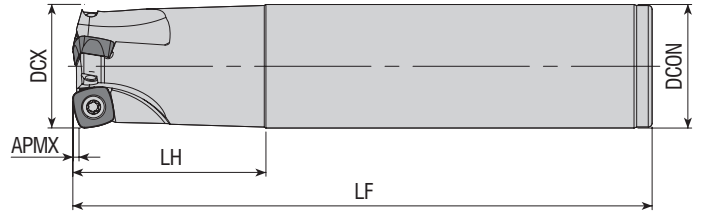

Takım Kodu Ordering Code Bestell-Bezeichnung	Stok Stock Lager	Takım Ölçüleri (mm) Dimension (mm) Abmessung (mm)						Kesici Uç Insert Wendeschneidplatte	Yedek Parçaları / Spare Parts / Ersatzteile		
		DCX	ZEFP	DCON	LF	LH	APMX		Sıkma Vidası Screw Schraube	Tork Anahtar Torx Key Torx-Schlüssel	
AHFM-SP1004-D25-C25-L150-Z02	●	25	2	25	150	50	1.5	SPNW 1004..		3015-M3.5x9	
AHFM-SP1004-D32-C32-L150-Z03	●	32	3	32	150	50	1.5				

R: Sağ / Right / Rechts L: Sol/Left/Links

● Stokta / In Stock / Auf Lager ○ Stokta Yok / Non Stock Item / Kein Lagerartikel, Lieferzeit auf Anfrage



DJT Ucuna Uygun. / Compatible with DJT Insert. Kompatibel mit DJT Wendeplatten.

Sipariş Örneği/Ordering Example/Bestellbeispiel

1 ad./pcs./stück AHFM-S00803-D20-W20-L150-Z02

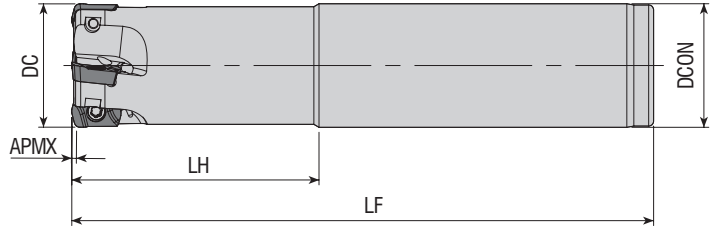
Kesme Hesabı : S 367 / Cutting Calculation : P 367 / Schnittberechnung : 367



Takım Kodu Ordering Code Bestell-Bezeichnung	Stok Stock Lager	Takım Ölçüleri (mm) Dimension (mm) Abmessung (mm)						Kesici Uç Insert Wendeschneidplatte	Yedek Parçaları / Spare Parts / Ersatzteile		
		DC	ZEFP	DCON	LF	LH	APMX		Sıkma Vidası Screw Schraube	Tork Anahtar Torx Key Torx-Schlüssel	
AHFM-YP1003-D16-C15-L150-Z02-F	●	16	2	15	150	20	1	 <b>EP. 1003..</b> <b>YPHW 1003..</b> <b>ZPMT 1003..</b>	 3008-M2.5x5	 80-T08	
AHFM-YP1003-D16-C15-L200-Z02-F	●	16	2	15	200	20	1				
AHFM-YP1003-D16-C16-L150-Z02-F	●	16	2	16	150	50	1				
AHFM-YP1003-D17-C16-L150-Z02-F	●	17	2	16	150	20	1				
AHFM-YP1003-D17-C16-L200-Z02-F	●	17	2	16	200	20	1				
AHFM-YP1003-D20-C18-L150-Z03-F	●	20	3	18	150	25	1				
AHFM-YP1003-D20-C18-L200-Z03-F	●	20	3	18	200	25	1				
AHFM-YP1003-D20-C20-L150-Z03-F	●	20	3	20	150	50	1				
AHFM-YP1003-D21-C20-L150-Z03-F	●	21	3	20	150	20	1				
AHFM-YP1003-D21-C20-L150-Z03-H	●	21	3	20	150	20	1				
AHFM-YP1003-D21-C20-L150-Z04-F	●	21	4	20	150	20	1				
AHFM-YP1003-D21-C20-L200-Z03	●	21	3	20	200	20	1				
AHFM-YP1003-D21-C20-L200-Z03-F	●	21	3	20	200	20	1				
AHFM-YP1003-D25-C20-L150-Z04-F	●	25	4	20	150	25	1				
AHFM-YP1003-D25-C20-L200-Z04-F	●	25	4	20	200	25	1				
AHFM-YP1003-D25-C25-L150-Z04-F	●	25	4	25	150	50	1				
AHFM-YP1003-D26-C25-L150-Z04	●	26	4	25	150	30	1				
AHFM-YP1003-D26-C25-L150-Z04-F	●	26	4	25	150	30	1				
AHFM-YP1003-D26-C25-L200-Z03-F	●	26	3	25	200	30	1				
AHFM-YP1003-D26-C25-L200-Z04-F	●	26	4	25	200	30	1				

R: Sağ / Right / Rechts L: Sol/Left/Links

● Stokta / In Stock / Auf Lager ○ Stokta Yok / Non Stock Item / Kein Lagerartikel, Lieferzeit auf Anfrage

DJT Ucuna Uygunudur. / Compatible with DJT Insert. Kompatibel mit DJT Wendeschneidplatten.

Çap Ölçüsü - 0,02 mm Olarak üretiliyor. F: ± 0,02 mm Demektir. Ör: Ø16 Takım 15,98 ± 0,02 mm yani 16,00 mm - 15,96 mm Olmalıdır.

Diameter Size is produced as - 0,02 mm. F: means ± 0,02 mm. For example: Ø16 tool 15,98 ± 0,02 mm, it means that it should be 16,00 mm - 15,96 mm.

Durchmesser - Es wird mit -0,02 mm hergestellt. Das heißt F: ± 0,02 mm. Zum Beispiel: Der Ø16-Satz sollte 15,98 ± 0,02 mm, 16,00 mm - 15,96 mm betragen.

Sipariş Örneği/Ordering Example/Bestellbeispiel

1 ad./pcs./stück AHFM-YP1003-D16-C15-L150-Z02-F

Kesme Hesabı : S 367 / Cutting Calculation : P 367 / Schnittberechnung : 367



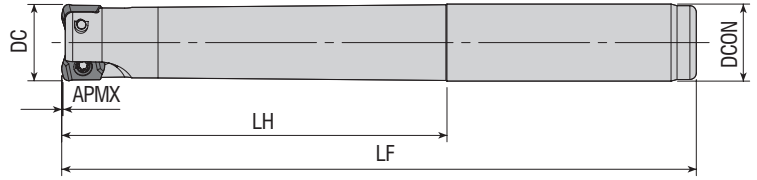

Takım Kodu Ordering Code Bestell-Bezeichnung	Stok Stock Lager	Takım Ölçüleri (mm) Dimension (mm) Abmessung (mm)						Kesici Uç Insert Wendeschneidplatte	Yedek Parçaları / Spare Parts / Ersatzteile		
		DC	ZEFP	DCON	LF	LH	APMX		Sıkma Vidası Screw Schraube	Tork Anahtar Torx Key Torx-Schlüssel	
AHFM-Y00602-D10-C09-L120-Z02-F	●	10	2	9	120	15	0.3	YOHW 0602..	3006-M1.8X4	80-T06	
AHFM-Y00602-D10-C10-L080-Z02-F	●	10	2	10	80	20	0.3				
AHFM-Y00602-D10-C10-L120-Z02-F	●	10	2	10	120	60	0.3				
AHFM-Y00602-D10-C10-L120-Z02-H-F	●	10	2	10	120	60	0.3				
AHFM-Y00602-D10-C10-L120-Z02-H	●	10	2	10	120	60	0.3				
AHFM-Y00602-D12-C11-L120-Z02-F	●	12	2	11	120	15	0.3				
AHFM-Y00602-D12-C11-L120-Z02-H-F	●	12	2	11	120	15	0.3				
AHFM-Y00602-D12-C11-L120-Z02-H	●	12	2	11	120	15	0.3				
AHFM-Y00602-D12-C11-L120-Z03-F	●	12	3	11	120	15	0.3				
AHFM-Y00602-D12-C12-L080-Z02-F	●	12	2	12	80	20	0.3				
AHFM-Y00602-D12-C12-L080-Z03-F	●	12	3	12	80	20	0.3				
AHFM-Y00602-D12-C12-L120-Z02-F	●	12	2	12	120	60	0.3				
AHFM-Y00602-D12-C12-L120-Z02-H	●	12	2	12	120	60	0.3				
AHFM-Y00602-D12-C12-L120-Z03-F	●	12	3	12	120	60	0.3				
AHFM-Y00602-D12-C12-L120-Z03-H	●	12	3	12	120	60	0.3				

DJT Ucuna Uygunur. / Compatible with DJT Insert. Kompatibel mit DJT Wendeplatten.

F: Eksenel ve Radyal Salgı Değeri 0,02 mm içindedir. / F: Axial and radial runout value is within 0,02mm / F: Der axiale und radiale Rundlaufwert liegt innerhalb von 0,02 mm.

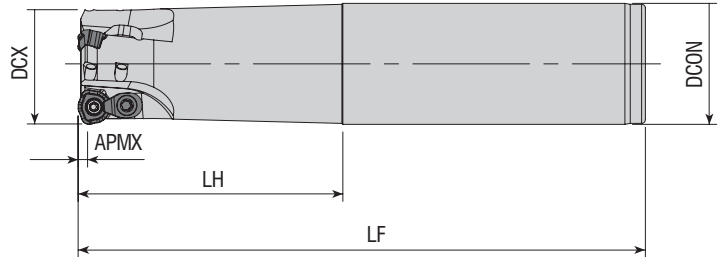

Takım Kodu Ordering Code Bestell-Bezeichnung	Stok Stock Lager	Takım Ölçüleri (mm) Dimension (mm) Abmessung (mm)						Kesici Uç Insert Wendeschneidplatte	Yedek Parçaları / Spare Parts / Ersatzteile			
		DCX	ZEFP	DCON	LF	LH	APMX		Sıkma Vidası Screw Schraube	Baskı Parçası Wedge Clamp Spannpratze	Baskı Vidası Clamp Screw Klemmschraube	Tork Anahtar Torx Key Torx-Schlüssel
AHFM-WD0603-D16-C16-L150-Z02	●	16	2	16	150	70	2	WDMT 0603..	3008-M2.5x6	-	-	80-T08
AHFM-WD0603-D20-C20-L150-Z03	●	20	3	20	150	70	2	WDMT 0603..	3008-M2.5x6	-	-	80-T08
AHFMC-WD0804-D25-C25-L150-Z02	●	25	2	25	150	70	1.5	WDMT 0804..	4010-M3X8	ACK-15	4010-M3x8	80-T10
AHFMC-WD0804-D32-C32-L150-Z03	●	32	3	32	150	70	1.5	WDMT 0804..	4010-M3X8	ACK-15	4010-M3x8	80-T10
AHFMC-WD1205-D32-C32-L150-Z02	●	32	2	32	150	70	3	WDMT 1205..	1415-M4x11	ACK-05	4015-M4x11	80-T15

R: Sağ / Right / Rechts L: Sol/Left/Links

● Stokta / In Stock / Auf Lager ○ Stokta Yok / Non Stock Item / Kein Lagerartikel, Lieferzeit auf Anfrage  
SMTM Ucuna Uygunur. / Compatible with SMTM Insert. Kompatibel mit SMTM Wendeplatten.

Sipariş Örneği/Ordering Example/Bestellbeispiel

1 ad./pcs./stück AHFM-Y00602-D10-C09-L120-Z02-F

Kesme Hesabı : S 367 / Cutting Calculation : P 367 / Schnittberechnung : 367

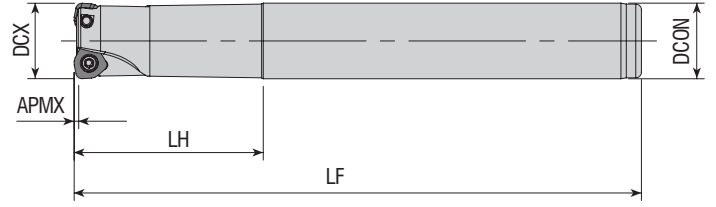

Takım Kodu Ordering Code Bestell-Bezeichnung	Stok Stock Lager	Takım Ölçüleri (mm) Dimension (mm) Abmessung (mm)						Kesici Uç Insert Wendeschneidplatte	Yedek Parçaları / Spare Parts / Ersatzteile			
		DCX	ZEFP	DCON	LF	LH	APMX		Sıkma Vidası Screw Schraube	Baskı Parçası Wedge Clamp Spannpratze	Baskı Vidası Clamp Screw Klemmschraube	Tork Anahtar Torx Key Torx-Schlüssel
AHFM-WD0503D-D20-C20-L150-Z02	●	20	2	20	150	50	1.25			-	-	
AHFM-WD0503D-D21-C20-L150-Z02	●	21	2	20	150	30	1.25	WD.W 0503..	4010-M3x6	-	-	80-T10
AHFMC-WD06T3D-D26-C25-L200-Z02	●	26	2	25	200	30	1.5					
AHFMC-WD06T3D-D33-C32-L200-Z03	●	33	3	32	200	32	1.5	WD.W 06T3..	3015-M3.5x9	ACK-15	4015-M3.5x11	80-T15

DJT Ucuna Uygundur. / Compatible with DJT Insert. Kompatibel mit DJT Wendeplatten.

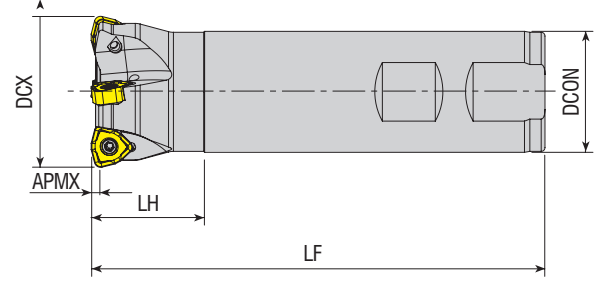

Takım Kodu Ordering Code Bestell-Bezeichnung	Stok Stock Lager	Takım Ölçüleri (mm) Dimension (mm) Abmessung (mm)						Kesici Uç Insert Wendeschneidplatte	Yedek Parçaları / Spare Parts / Ersatzteile	
		DCX	ZEFP	DCON	LF	LH	APMX		Sıkma Vidası Screw Schraube	Tork Anahtar Torx Key Torx-Schlüssel
AHFM-WN0603-D16-C16-L110-Z02-H	●	16	2	16	110	30	1			
AHFM-WN0603-D16-C16-L150-Z02-H	●	16	2	16	150	70	1	WNMX 0603..	3008-M2.5x6	80-T08
AHFM-WN0603-D17-C16-L150-Z02-H	●	17	2	16	150	20	1			
AHFM-WN0603-D20-C20-L150-Z02-H	●	20	2	20	150	70	1			
AHFM-WN0603-D20-C20-L200-Z02-H	●	20	2	20	200	100	1			
AHFM-WN0603-D21-C20-L150-Z02-H	●	21	2	20	150	20	1			
AHFM-WN09T3-D25-W25-L120-Z02-H	●	25	2	25	120	40	1.5	WNMX 09T3..	4010-M3x8	80-T10
AHFML-WN09T3-D25-W25-L120-Z02-H	●	25	2	25	120	40	1.5			
AHFM-WN09T3-D25-C25-L200-Z02	●	25	2	25	200	120	1.5			
AHFM-WN09T3-D32-W32-L120-Z03-H	●	32	3	32	120	30	1.5			
AHFM-WN09T3-D32-W32-L200-Z03-H	○	32	3	32	200	100	1.5			
AHFM-WN09T3-D35-W32-L200-Z04-H	●	35	4	32	200	50	1.5			
AHFM-WN09T3-D40-W32-L120-Z04-H	●	40	4	32	120	30	1.5			
AHFM-WN09T3-D40-C32-L200-Z04	●	40	4	32	200	30	1.5			
AHFM-WN1305-D32-C32-L150-Z02-H	○	32	2	32	150	70	2	WNMX 1305..	4015-M4x11	80-T15
AHFM-WN1305-D32-C32-L200-Z02-H	●	32	2	32	200	120	2			
AHFM-WN1305-D40-C32-L200-Z03-H	●	40	3	32	200	30	2			

R: Sağ / Right / Rechts L: Sol/Left/Links

● Stokta / In Stock / Auf Lager ○ Stokta Yok / Non Stock Item / Kein Lagerartikel, Lieferzeit auf Anfrage  
KRYL Ucuna Uygundur. / Compatible with KRYL Insert. Kompatibel mit KRYL Wendeplatten.

Sipariş Örneği/Ordering Example/Bestellbeispiel

1 ad./pcs./stück AHFM-WD0503D-D20-C20-L150-Z02

Kesme Hesabı : S 367 / Cutting Calculation : P 367 / Schnittberechnung : 367



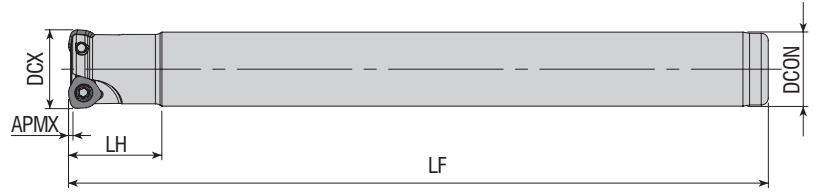

Takım Kodu Ordering Code Bestell-Bezeichnung	Stok Stock Lager	Takım Ölçüleri (mm) Dimension (mm) Abmessung (mm)						Kesici Uç Insert Wendeschneidplatte	Yedek Parçaları / Spare Parts / Ersatzteile		
		DCX	ZEFP	DCON	LF	LH	APMX		Sıkma Vidası Screw Schraube	Tork Anahtar Torx Key Torx-Schlüssel	
AHFM-W004T2D-D16-C16-L150-Z02	●	16	2	16	150	20	0.8	WOMW 04T2..	3008-M2.5x6	80-T08	
AHFM-W004T2D-D17-C16-L150-Z02	●	17	2	16	150	20	0.8				

DJT Ucuna Uygunur. / Compatible with DJT Insert. Kompatibel mit DJT Wendeplatten.

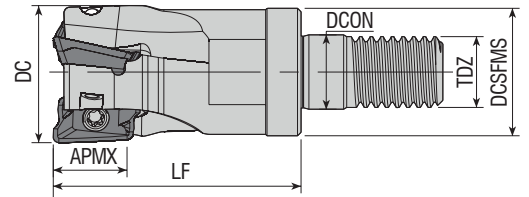

Takım Kodu Ordering Code Bestell-Bezeichnung	Stok Stock Lager	Takım Ölçüleri (mm) Dimension (mm) Abmessung (mm)							Kesici Uç Insert Wendeschneidplatte	Yedek Parçaları / Spare Parts / Ersatzteile		
		DC	Z	DCSFMS	TDZ	LF	DCON	APMX		Sıkma Vidası Screw Schraube	Tork Anahtar Torx Key Torx-Schlüssel	
AEM90-A01236-D16-M08-L30-Z02	●	16	2	14.8	M08	30	8.5	10	AO.. 1236..	3008-M2.5x6	80-T08	
AEM90-A01236-D20-M10-L35-Z03	●	20	3	18	M10	35	10.5	10				

R: Sağ / Right / Rechts L: Sol/Left/Links

● Stokta / In Stock / Auf Lager ○ Stokta Yok / Non Stock Item / Kein Lagerartikel, Lieferzeit auf Anfrage  
MTSBH Ucuna Uygunur. / Compatible with MTSBH Insert. Kompatibel mit MTSBH Wendeplatten.

Sipariş Örneği/Ordering Example/Bestellbeispiel

1 ad./pcs./stück AHFM-W004T2D-D16-C16-L150-Z02

Kesme Hesabı : S 367 / Cutting Calculation : P 367 / Schnittberechnung : 367

Sıkma Tork Değeri : S 366 / Tightening Torque : P 366 / Anzugsmoment : 366

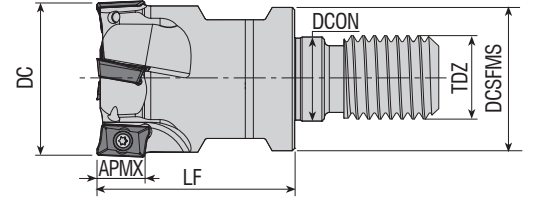

Takım Kodu Ordering Code Bestell-Bezeichnung	Stok Stock Lager	Takım Ölçüleri (mm) Dimension (mm) Abmessung (mm)							Kesici Uç Insert Wendeschneidplatte	Yedek Parçaları / Spare Parts / Ersatzteile	
		DC	ZEFP	DCSFMS	TDZ	LF	DCON	APMX		Sıkma Vidası Screw Schraube	Tork Anahtar Torx Key Torx-Schlüssel
AEM90-AD1505D-D25-M12-L43-Z02-H	●	25	2	21	M12	43	12.5	14.3	ADKT 150508	4015-M4x9	80-T15
AEM90-AD1505D-D32-M16-L43-Z03-H	●	32	3	29	M16	43	17	14.3		4015-M4x11	

DJT Ucuna Uygundur. / Compatible with DJT Insert. Kompatibel mit DJT Wendeplatten.

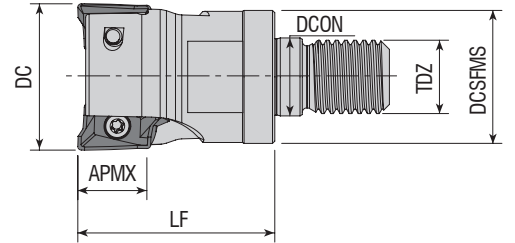

Takım Kodu Ordering Code Bestell-Bezeichnung	Stok Stock Lager	Takım Ölçüleri (mm) Dimension (mm) Abmessung (mm)							Kesici Uç Insert Wendeschneidplatte	Yedek Parçaları / Spare Parts / Ersatzteile	
		DC	ZEFP	DCSFMS	TDZ	LF	DCON	APMX		Sıkma Vidası Screw Schraube	Tork Anahtar Torx Key Torx-Schlüssel
AEM90-AX1235-D16-M08-L30-Z02-H	●	16	2	14.75	M08	30	8.5	10	AX.T 1235..	3108-M3x6	80-T08
AEM90-AX1235-D20-M10-L30-Z03-H	●	20	3	18	M10	30	10.5	10			
AEM90-AX1235-D25-M12-L35-Z04-H	●	25	4	21	M12	35	12.5	10	AX.T 1705..	4015-M4x9	80-T15
AEM90-AX1705-D25-M12-L43-Z02-H	●	25	2	21	M12	43	12.5	14			
AEM90-AX1705-D32-M16-L43-Z02-H	●	32	2	29	M16	43	17	14			

R: Sağ / Right / Rechts L: Sol/Left/Links

● Stokta / In Stock / Auf Lager ○ Stokta Yok / Non Stock Item / Kein Lagerartikel, Lieferzeit auf Anfrage  
SMTM Ucuna Uygundur. / Compatible with SMTM Insert. Kompatibel mit SMTM Wendeplatten.

Sipariş Örneği/Ordering Example/Bestellbeispiel

1 ad./pcs./stück AEM90-AD1505D-D25-M12-L43-Z02-H

Kesme Hesabı : S 367 / Cutting Calculation : P 367 / Schnittberechnung : 367

Sıkma Tork Değeri : S 367 / Tightening Torque : P 367 / Anzugsmoment : 367



KAPR=90°

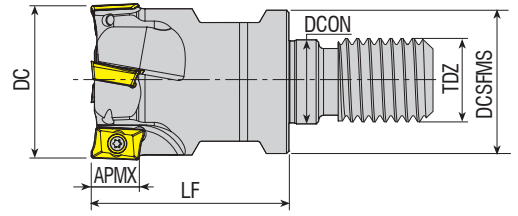

**Takım Kodu**  
**Ordering Code**  
**Bestell-Bezeichnung**

Stok  
Stock  
Lager

Takım Ölçüleri (mm)  
Dimension (mm)  
Abmessung (mm)

Kesici Uç  
Insert  
Wendeschneidplatte

Yedek Parçaları / Spare Parts / Ersatzteile

Sıkma Vidası  
Screw  
Schraube

Tork Anahtar  
Torx Key  
Torx-Schlüssel

DC ZEPF DCSFMS TDZ LF DCON APMX



AEM90-AP0903-D20-M12-L35-Z03	●	20	3	18	M12	35	12.5	9	APMT 0903.. KRYL UCUNA UYGUNDUR. FOR KRYL INSERT. Kompatibel mit Wendeschneidplatte KRYL	3008-M2.5x6	80-T08
AEM90-AP0903-D25-M12-L35-Z03	●	25	3	21	M12	35	12.5	9			
AEM90-AP10-D16-M08-L30-Z02-H	●	16	2	14.75	M08	30	8.5	10			
AEM90-AP10-D20-M10-L30-Z03-H	●	20	3	18	M10	30	10.5	10	AP. 1003.. ISO UCUNA UYGUNDUR. FOR ISO INSERT. Kompatibel mit Wendeschneidplatte ISO	3008-M2.5x6	80-T08
AEM90-AP10-D25-M12-L35-Z03-H	●	25	3	21	M12	35	12.5	10			
AEM90-AP10-D32-M16-L35-Z04-H	●	32	4	29	M16	35	17	10			
AEM90-AP10-D32-M16-L40-Z04-H	●	32	4	29	M16	40	17	10	AP. 1003.. DJT UCUNA UYGUNDUR. FOR DJT INSERT. Kompatibel mit Wendeschneidplatte DJT	3008-M2.5x6	80-T08
AEM90-AP10-D40-M16-L43-Z05-H	●	40	5	29	M16	43	17	10			
AEM90-AP10-D42-M16-L43-Z05-H	●	42	5	29	M16	43	17	10			
AEM90-AP10D-D16-M08-L30-Z02-H	●	16	2	14.75	M08	30	8.5	10	AP. 1003.. DJT UCUNA UYGUNDUR. FOR DJT INSERT. Kompatibel mit Wendeschneidplatte DJT	3008-M2.5x6	80-T08
AEM90-AP10D-D20-M10-L30-Z03-H	●	20	3	18	M10	30	10.5	10			
AEM90-AP10D-D25-M12-L35-Z03-H	●	25	3	21	M12	35	12.5	10			
AEM90-AP11-D16-M08-L30-Z02-H	●	16	2	14.75	M08	30	8.5	11	AP. 11T3.. ZCC UCUNA UYGUNDUR. FOR ZCC INSERT. Kompatibel mit Wendeschneidplatte ZCC	3008-M2.5x6	80-T08
AEM90-AP11-D20-M10-L30-Z03-H	●	20	3	18	M10	30	10.5	11			
AEM90-AP11-D25-M12-L35-Z03-H	●	25	3	21	M12	35	12.5	11			
AEM90-AP11-D32-M16-L35-Z04-H	●	32	4	29	M16	35	17	11	AP. 11T3.. ZCC UCUNA UYGUNDUR. FOR ZCC INSERT. Kompatibel mit Wendeschneidplatte ZCC	3008-M2.5x6	80-T08
AEM90-AP11-D40-M16-L43-Z05-H	●	40	5	29	M16	43	17	11			
AEM90-AP16-D25-M12-L43-Z02-H	●	25	2	21	M12	43	12.5	16			
AEM90-AP16-D32-M16-L43-Z03-H	●	32	3	29	M16	43	17	16	AP. 1604.. ISO UCUNA UYGUNDUR. FOR ISO INSERT. Kompatibel mit Wendeschneidplatte ISO	4015-M4x9	80-T15
AEM90-AP16-D40-M16-L43-Z04-H	●	40	4	29	M16	43	17	16			
AEM90-AP16-D42-M16-L43-Z04-H	●	42	4	29	M16	43	17	16			
AEM90-AP16D-D25-M12-L43-Z02-H	●	25	2	21	M12	43	12.5	16	AP. 1604.. DJT UCUNA UYGUNDUR. FOR DJT INSERT. Kompatibel mit Wendeschneidplatte DJT	4015-M4x9	80-T15
AEM90-AP16D-D32-M16-L43-Z03-H	●	32	3	29	M16	43	17	16			
AEM90-AP16D-D40-M16-L43-Z04-H	●	40	4	29	M16	43	17	16			
AEM90-AP16L-D25-M12-L43-Z02-H	●	25	2	21	M12	43	12.5	16	AP. 1604.. LMN UCUNA UYGUNDUR. FOR LMN INSERT. Kompatibel mit Wendeschneidplatte LMN	4015-M4x9	80-T15
AEM90-AP16L-D32-M16-L43-Z03-H	●	32	3	29	M16	43	17	16			
AEM90-AP16L-D40-M16-L43-Z04-H	●	40	4	29	M16	43	17	16			

R: Sağ / Right / Rechts L: Sol/Left/Links

● Stokta / In Stock / Auf Lager ○ Stokta Yok / Non Stock Item / Kein Lagerartikel, Lieferzeit auf Anfrage

Sipariş Örneği/Ordering Example/Bestellbeispiel

1 ad./pcs./stück AEM90-AP0903-D20-M12-L35-Z03

Kesme Hesabı : S 367 / Cutting Calculation : P 367 / Schnittberechnung : 367

Sıkma Tork Değeri : S 367 / Tightening Torque : P 367 / Anzugsmoment : 367



KAPR=90°

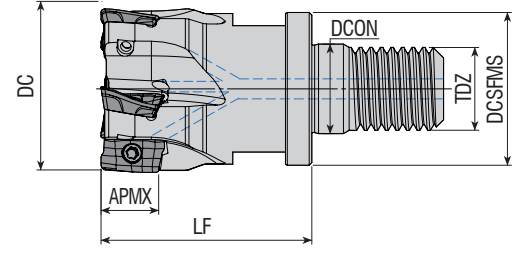

Takım Kodu Ordering Code Bestell-Bezeichnung	Stok Stock Lager	Takım Ölçüleri (mm) Dimension (mm) Abmessung (mm)							Kesici Uç Insert Wendeschneidplatte	Yedek Parçaları / Spare Parts / Ersatzteile	
		DC	ZEFP	DCSFMS	TDZ	LF	DCON	APMX		Sıkma Vidası Screw Schraube	Tork Anahtar Torx Key Torx-Schlüssel
AEM90-BD11T3-D16-M08-L25-Z02-H	●	16	2	14.75	M08	25	8.5	10			
AEM90-BD11T3-D25-M12-L35-Z04-H	●	25	4	21	M12	35	12.5	10			
AEM90-BD11T3-D32-M16-L40-Z05-H	●	32	5	29	M16	40	17	10			

KYCR Ucuna Uygunur. / Compatible with KYCR Insert. Kompatibel mit KYCR Wendeplatten.

KAPR=90°

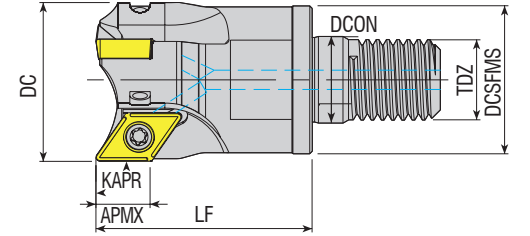

Takım Kodu Ordering Code Bestell-Bezeichnung	Stok Stock Lager	Takım Ölçüleri (mm) Dimension (mm) Abmessung (mm)							Kesici Uç Insert Wendeschneidplatte	Yedek Parçaları / Spare Parts / Ersatzteile	
		DC	ZEFP	DCSFMS	TDZ	LF	DCON	APMX		Sıkma Vidası Screw Schraube	Tork Anahtar Torx Key Torx-Schlüssel
AEM90-DC07-D20-M10-L30-Z02-H	●	20	2	18	M10	30	10.5	7			
AEM90-DC07-D25-M12-L35-Z03-H	●	25	3	21	M12	35	12.5	7			
AEM90-DC07-D32-M16-L43-Z04-H	●	32	4	29	M16	43	17	7			
AEM90-DC07-D40-M16-L43-Z05-H	●	40	5	29	M16	43	17	7			
AEM90-DC11-D32-M16-L43-Z03-H-F	●	32	3	29	M16	43	17	11			
AEM90-DC11-D40-M16-L43-Z03-H-F	●	40	3	29	M16	43	17	11			

R: Sağ / Right / Rechts L: Sol/Left/Links

● Stokta / In Stock / Auf Lager ○ Stokta Yok / Non Stock Item / Kein Lagerartikel, Lieferzeit auf Anfrage

ISO Ucuna Uygunur. / Compatible with ISO Insert. Kompatibel mit ISO Wendeplatten.



F: Eksenel ve Radyal Salgı Değeri 0,02 mm içindedir. / F: Axial and Radial Runout Value is within 0,02 mm. / F: Der axiale und radiale Rundlaufwert liegt innerhalb von 0,02 mm.

Sipariş Örneği/Ordering Example/Bestellbeispiel

1 ad./pcs./stück AEM90-BD11T3-D16-M08-L25-Z02-H

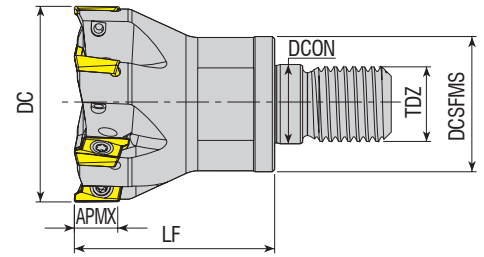



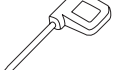

Takım Kodu Ordering Code Bestell-Bezeichnung	Stok Stock Lager	Takım Ölçüleri (mm) Dimension (mm) Abmessung (mm)							Kesici Uç Insert Wendeschneidplatte	Yedek Parçaları / Spare Parts / Ersatzteile		
		DC	ZEFP	DCSFMS	TDZ	LF	DCON	APMX		Sıkma Vidası Screw Schraube	Tork Anahtar Torx Key Torx-Schlüssel	
AEM90-RT10-D16-M08-L20-Z02-H	●	16	2	14.75	M08	20	8.5	10				
AEM90-RT10-D20-M10-L25-Z03-H	●	20	3	18	M10	25	10.5	10				
AEM90-RT10-D25-M12-L30-Z04-H	●	25	4	21	M12	30	12.5	10				
AEM90-RT10-D32-M16-L43-Z05-H	●	32	5	29	M16	43	17	10				
AEM90-RT10-D42-M16-L43-Z06-H	●	42	6	29	M16	43	17	10				

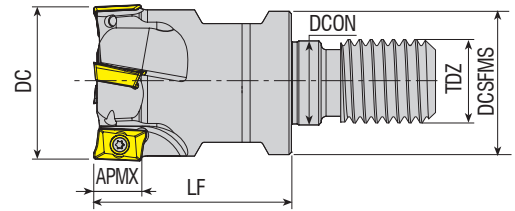
SFTY Ucuna Uygundur. / Compatible with SFTY Insert. Kompatibel mit SFTY Wendeplatten.



Takım Kodu Ordering Code Bestell-Bezeichnung	Stok Stock Lager	Takım Ölçüleri (mm) Dimension (mm) Abmessung (mm)							Kesici Uç Insert Wendeschneidplatte	Yedek Parçaları / Spare Parts / Ersatzteile		
		DC	ZEFP	DCSFMS	TDZ	LF	DCON	APMX		Sıkma Vidası Screw Schraube	Tork Anahtar Torx Key Torx-Schlüssel	
AEM90-R390.11-D16-M08-L30-Z02-H	●	16	2	14.75	M08	30	8.5	10				
AEM90-R390.11-D20-M10-L30-Z03-H	●	20	3	18	M10	30	10.5	10				
AEM90-R390.11-D25-M12-L35-Z03-H	●	25	3	21	M12	35	12.5	10				
AEM90-R390.11-D32-M16-L43-Z04-H	●	32	4	29	M16	43	17	10				
AEM90-R390.11-D42-M16-L43-Z06-H	●	42	6	29	M16	43	17	10				

R: Sağ / Right / Rechts L: Sol/Left/Links

● Stokta / In Stock / Auf Lager ○ Stokta Yok / Non Stock Item / Kein Lagerartikel, Lieferzeit auf Anfrage  
SNDVK Ucuna Uygundur. / Compatible with SNDVK Insert. Kompatibel mit SNDVK Wendeplatten.

Sipariş Örneği/Ordering Example/Bestellbeispiel  
1 ad./pcs./stück AEM90-RT10-D16-M08-L20-Z02-H



KAPR=90°

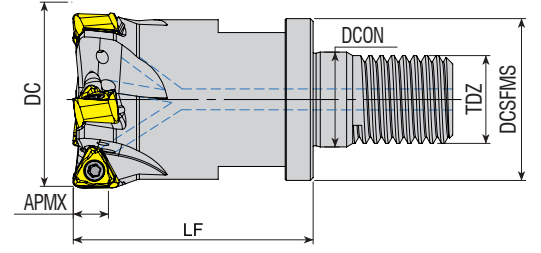

Takım Kodu Ordering Code Bestell-Bezeichnung	Stok Stock Lager	Takım Ölçüleri (mm) Dimension (mm) Abmessung (mm)							Kesici Uç Insert Wendeschneidplatte	Yedek Parçaları / Spare Parts / Ersatzteile	
		DC	ZEFP	DCSFMS	TDZ	LF	DCON	APMX		Sıkma Vidası Screw Schraube	Tork Anahtar Torx Key Torx-Schlüssel
AEM90-TNG10-D21-M10-L25-Z03-H	●	21	3	18	M10	25	10.5	5	TNGX 1004..	3008-M2.5x6	80-T08
AEM90-TNG10-D26-M12-L30-Z04-H	●	26	4	21	M12	30	12.5	5			
AEM90-TNG10-D33-M16-L43-Z05-H	●	33	5	29	M16	43	17	5			
AEM90-TNG10-D35-M16-L43-Z05-H	●	35	5	29	M16	43	17	5			

PRMT Ucuna Uygundur. / Compatible with PRMT Insert. Kompatibel mit PRMT Wendeplatten.

KAPR=90°

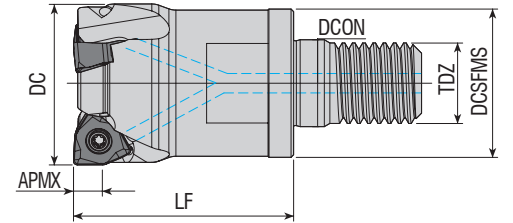

Takım Kodu Ordering Code Bestell-Bezeichnung	Stok Stock Lager	Takım Ölçüleri (mm) Dimension (mm) Abmessung (mm)							Kesici Uç Insert Wendeschneidplatte	Yedek Parçaları / Spare Parts / Ersatzteile	
		DC	ZEFP	DCSFMS	TDZ	LF	DCON	APMX		Sıkma Vidası Screw Schraube	Tork Anahtar Torx Key Torx-Schlüssel
AEM90-WN0604Z-D25-M12-L35-Z02-H	●	25	2	21	M12	35	12.5	5.7	WNHU 0604..	3008-M3x8	80-T08
AEM90-WN0604Z-D32-M16-L43-Z03-H	●	32	3	29	M16	43	17	5.7			
AEM90-WN0604Z-D40-M16-L43-Z04-H	●	40	4	29	M16	43	17	5.7			

R: Sağ / Right / Rechts L: Sol/Left/Links

● Stokta / In Stock / Auf Lager ○ Stokta Yok / Non Stock Item / Kein Lagerartikel, Lieferzeit auf Anfrage  
ZCC Ucuna Uygundur. / Compatible with ZCC Insert. Kompatibel mit ZCC Wendeplatten.

Sipariş Örneği/Ordering Example/Bestellbeispiel

1 ad./pcs./stück AEM90-TNG10-D21-M10-L25-Z03-H

Kesme Hesabı : S 367 / Cutting Calculation : P 367 | Schnittberechnung : 367

Sıkma Tork Değeri : S 367 / Tightening Torque : P 367 | Anzugsmoment : 367

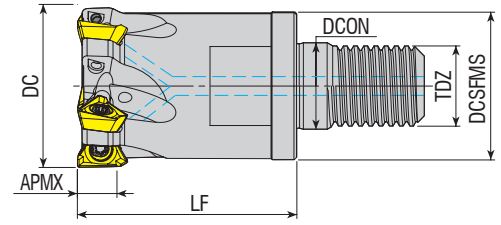

Takım Kodu Ordering Code Bestell-Bezeichnung	Stok Stock Lager	Takım Ölçüleri (mm) Dimension (mm) Abmessung (mm)							Kesici Uç Insert Wendeschneidplatte	Yedek Parçaları / Spare Parts / Ersatzteile		
		DC	ZEFP	DCSFMS	TDZ	LF	DCON	APMX		Sıkma Vidası Screw Schraube	Tork Anahtar Torx Key Torx-Schlüssel	
AEM90-3P1004-D20-M10-L35-Z02	●	20	2	18	10	35	10.5	7				
AEM90-3P1004-D32-M16-L43-Z05-H	●	32	5	29	16	43	17	7				

TGTC Ucuna Uygundur. / Compatible with TGTC Insert. Kompatibel mit TGTC Wendeplatten.

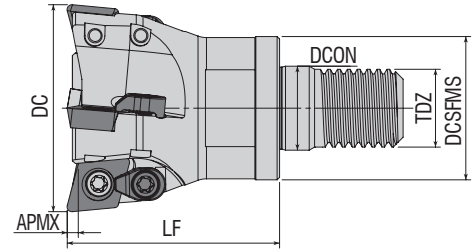

Takım Kodu Ordering Code Bestell-Bezeichnung	Stok Stock Lager	Takım Ölçüleri (mm) Dimension (mm) Abmessung (mm)							Kesici Uç Insert Wendeschneidplatte	Yedek Parçaları / Spare Parts / Ersatzteile				
		DC	ZEFP	DCSFMS	TDZ	LF	DCON	APMX		Sıkma Vidası Screw Schraube	Baskı Parçası Wedge Clamp Spannpratze	Baskı Vidası Clamp Screw Klemmschraube	Tork Anahtar Torx Key Torx-Schlüssel	
AEM95-XD0206-D16-M08-L23-Z02-H	●	16	2	14.75	M08	23	8.5	1						
AEM95-XD0206-D16-M08-L23-Z02-H-F	●	16	2	14.75	M08	23	8.5	1						
AEM95-XD0206-D20-M10-L30-Z03-H	●	20	3	18	M10	30	10.5	1						
AEM95-XD0206-D20-M10-L30-Z03-H-F	●	20	3	18	M10	30	10.5	1						
AEM95-XD0206-D25-M12-L35-Z03-H	●	25	3	21	M12	35	12.5	1						
AEM95-XD0206-D25-M12-L35-Z03-H-F	●	25	3	21	M12	35	12.5	1						
AEM95C-XD0310-D35-M16-L43-Z03-H	●	35	3	29	M16	43	17	1.5						
AEM95C-XD0310-D35-M16-L43-Z03-H-F	●	35	3	29	M16	43	17	1.5						
AEM95C-XD0310-D42-M16-L43-Z04-H	●	42	4	29	M16	43	17	1.5						
AEM95C-XD0310-D42-M16-L43-Z04-H-F	●	42	4	29	M16	43	17	1.5						

R: Sağ / Right / Rechts L: Sol/Left/Links

● Stokta / In Stock / Auf Lager ○ Stokta Yok / Non Stock Item / Kein Lagerartikel, Lieferzeit auf Anfrage

DJT Ucuna Uygundur. / Compatible with DJT Insert. Kompatibel mit DJT Wendeplatten.

Çap Ölçüsü - 0,02 mm Olarak üretiliyor. F: ± 0,02 mm Demektir. Ör: Ø16 Takım 15,98 ± 0,02 mm yani 16,00 mm - 15,96 mm Olmalıdır.

Diameter Size is produced as - 0.02 mm. F: means ± 0.02 mm. For example: Ø16 tool 15.98 ± 0.02 mm, it means that it should be 16.00 mm - 15.96 mm.

Durchmesser - Es wird mit -0,02 mm hergestellt. Das heißt F: ± 0,02 mm. Zum Beispiel: Der Ø16-Satz sollte 15,98 ± 0,02 mm, 16,00 mm - 15,96 mm betragen.

Sipariş Örneği/Ordering Example/Bestellbeispiel

1 ad./pcs./stück AEM90-3P1004-D20-M10-L35-Z02

Kesme Hesabı : S 367 / Cutting Calculation : P 367 / Schnittberechnung : 367

Sıkma Tork Değeri : S 367 / Tightening Torque : P 367 / Anzugsmoment : 367

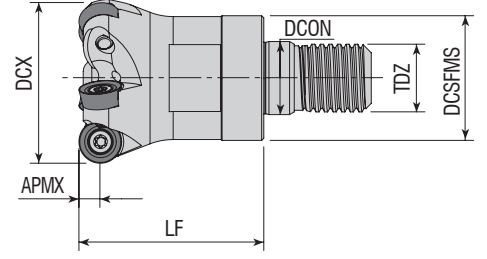

Takım Kodu Ordering Code Bestell-Bezeichnung	Stok Stock Lager	Takım Ölçüleri (mm) Dimension (mm) Abmessung (mm)							Kesici Uç Insert Wendeschneidplatte	Yedek Parçaları / Spare Parts / Ersatzteile	
		DCX	ZEFP	DCSFMS	TDZ	LF	DCON	APMX		Sıkma Vidası Screw Schraube	Tork Anahtar Torx Key Torx-Schlüssel
AEMR-RC10T3-D25-M12-L35-Z03-H	●	25	3	21	M12	35	12.5	5	RC.. 10T3..	4015-M4x9	80-T15
AEMR-RC10T3-D32-M16-L43-Z04-H	●	32	4	29	M16	43	17	5			
AEMR-RC10T3-D40-M16-L43-Z05-H	●	40	5	29	M16	43	17	5			

ZCC Ucuna Uygundur. / Compatible with ZCC Insert. Kompatibel mit ZCC Wendepalten.

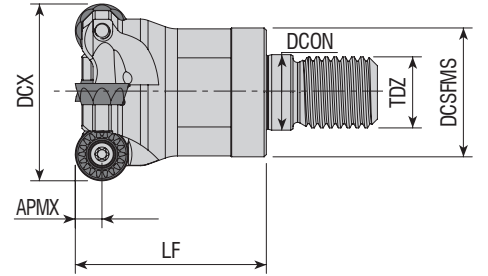

Takım Kodu Ordering Code Bestell-Bezeichnung	Stok Stock Lager	Takım Ölçüleri (mm) Dimension (mm) Abmessung (mm)							Kesici Uç Insert Wendeschneidplatte	Yedek Parçaları / Spare Parts / Ersatzteile	
		DCX	ZEFP	DCSFMS	TDZ	LF	DCON	APMX		Sıkma Vidası Screw Schraube	Tork Anahtar Torx Key Torx-Schlüssel
AEMR-RP08T2M-D20-M10-L30-Z02-H	●	20	2	18	M10	30	10.5	4	RPMT 08T2..	3008-M2.5x6	80-T08
AEMR-RP10T3M-D25-M12-L35-Z02-H	●	25	2	21	M12	35	12.5	5	RPMT 10T3..	4015-M3.5x9	80-T15
AEMR-RP10T3M-D32-M16-L43-Z03-H	●	32	3	29	M16	43	17	5	RPMT 1204..	4015-M4x9	
AEMR-RP1204M-D32-M16-L43-Z03-H	●	32	3	29	M16	43	17	6			
AEMR-RP1204M-D40-M16-L43-Z04-H	●	40	4	29	M16	43	17	6			

R: Sağ / Right / Rechts L: Sol/Left/Links

● Stokta / In Stock / Auf Lager ○ Stokta Yok / Non Stock Item / Kein Lagerartikel, Lieferzeit auf Anfrage  
MTSBSH Ucuna Uygundur. / Compatible with MTSBSH Insert. Kompatibel mit MTSBSH Wendepalten.



Sipariş Örneği/Ordering Example/Bestellbeispiel

1 ad./pcs./stück AEMR-RC10T3-D25-M12-L35-Z03-H

Kesme Hesabı : S 367 / Cutting Calculation : P 367 / Schnittberechnung : 367  
Sıkma Tork Değeri : S 367 / Tightening Torque : P 367 / Anzugsmoment : 367

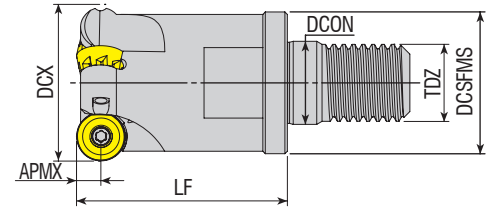



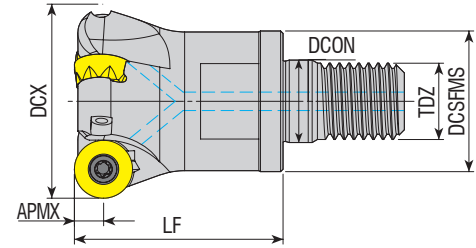

Takım Kodu Ordering Code Bestell-Bezeichnung	Stok Stock Lager	Takım Ölçüleri (mm) Dimension (mm) Abmessung (mm)							Kesici Uç Insert Wendeschneidplatte	Yedek Parçaları / Spare Parts / Ersatzteile				
		DCX	ZEFP	DCSFMS	TDZ	LF	DCON	APMX		Sıkma Vidası Screw Schraube	Tork Anahtar Torx Key Torx-Schlüssel			
AEMR-RP10T3-D25-M12-L35-Z02-H	●	25	2	21	M12	35	12.5	5						
AEMR-RP10T3-D32-M16-L43-Z03-H	●	32	3	29	M16	43	17	5				RPNX 10T3..	4010-M3x8	80-T10
AEMR-RP1204-D32-M16-L43-Z03-H	●	32	3	29	M16	43	17	6				RPNX 1204..	4015-M4x9	80-T15

CRTZT Ucuna Uygunur. / Compatiple with CRTZT Insert. Kompatibel mit CRTZT Wendeplatten.

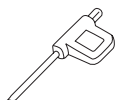

Takım Kodu Ordering Code Bestell-Bezeichnung	Stok Stock Lager	Takım Ölçüleri (mm) Dimension (mm) Abmessung (mm)							Kesici Uç Insert Wendeschneidplatte	Yedek Parçaları / Spare Parts / Ersatzteile				
		DCX	ZEFP	DCSFMS	TDZ	LF	DCON	APMX		Sıkma Vidası Screw Schraube	Tork Anahtar Torx Key Torx-Schlüssel			
AEMR-RY10-D32-M16-L43-Z04-H	●	32	4	29	M16	43	17	5						
AEMR-RY10-D40-M16-L43-Z05-H	●	40	5	29	M16	43	17	5				RYMX 1004..	4015-M3.5x9	80-T15
AEMR-RY12-D32-M16-L43-Z03-H	●	32	3	29	M16	43	17	6				RYMX 1205..	4015-M4x9	
AEMR-RY12-D40-M16-L43-Z03-H	●	40	3	29	M16	43	17	6						

R: Sağ / Right / Rechts L: Sol/Left/Links

● Stokta / In Stock / Auf Lager ○ Stokta Yok / Non Stock Item / Kein Lagerartikel, Lieferzeit auf Anfrage

TGTC Ucuna Uygunur. / Compatiple with TGTC Insert. Kompatibel mit TGTC Wendeplatten.

Sipariş Örneği/Ordering Example/Bestellbeispiel

1 ad./pcs./stück AEMR-RP10T3-D25-M12-L35-Z02-H

Kesme Hesabı : S 367 / Cutting Calculation : P 367 / Schnittberechnung : 367

Sıkma Tork Değeri : S 367 / Tightening Torque : P 367 / Anzugsmoment : 367

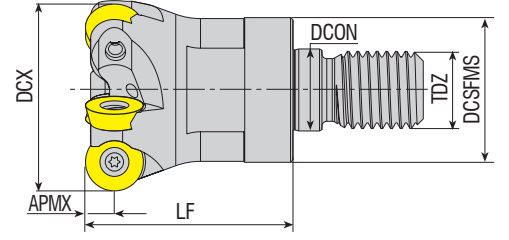

Takım Kodu Ordering Code Bestell-Bezeichnung	Stok Stock Lager	Takım Ölçüleri (mm) Dimension (mm) Abmessung (mm)							Kesici Uç Insert Wendeschneidplatte	Yedek Parçaları / Spare Parts / Ersatzteile			
		DCX	ZEPF	DCSFMS	TDZ	LF	DCON	APMX		Sıkma Vidası Screw Schraube	Tork Anahtar Torx Key Torx-Schlüssel		
AEMR-RD0702-D15-M08-L23-Z02-H	●	15	2	13	M08	23	8.5	3.5	RD.. 0702	3008-M2.5x6	80-T08		
AEMR-RD0702-D16-M08-L23-Z02-H	●	16	2	13	M08	23	8.5	3.5					
AEMR-RD0702-D20-M10-L30-Z04-H	●	20	4	18	M10	30	10.5	3.5					
AEMR-RD0702-D25-M12-L35-Z05-H	●	25	5	21	M12	35	12.5	3.5					
AEMR-RD0702-D30-M16-L42-Z05-H	●	30	5	29	M16	42	17	3.5					
AEMR-RD0702-D32-M16-L43-Z05-H	●	32	5	29	M16	43	17	3.5					
AEMR-RD0702-D35-M16-L42-Z06-H	●	35	6	29	M16	42	17	3.5					
AEMR-RD0702-D42-M16-L43-Z05-H	●	42	5	29	M16	43	17	3.5					
AEMR-RD0702-D42-M16-L43-Z07-H	●	42	7	29	M16	43	17	3.5					
AEMR-RD08T2-D16-M08-L23-Z02-H	●	16	2	13	M08	23	8.5	4	RD.. 08T2	3008-M2.5x6	80-T08		
AEMR-RD08T2-D16-M10-L23-Z02-H	●	16	2	13	M10	23	8.5	4					
AEMR-RD08T2-D20-M10-L30-Z03-H	●	20	3	18	M10	30	10.5	4					
AEMR-RD08T2-D25-M12-L35-Z04-H	●	25	4	21	M12	35	12.5	4					
AEMR-RD0802-D16-M08-L23-Z02-H	●	16	2	13	M08	23	8.5	4	RD.. 0802	3008-M3x6	80-T15		
AEMR-RD0803-D16-M08-L23-Z02-H	●	16	2	13	M08	23	8.5	4	RD.. 0803	3008-M3x8			
AEMR-RD0803-D20-M10-L30-Z03-H	●	20	3	18	M10	30	10.5	4					
AEMR-RD0803-D25-M12-L35-Z04-H	●	25	4	21	M12	35	12.5	4					
AEMR-RD1003-D20-M10-L30-Z02-H	●	20	2	18	M10	30	10.5	5	RD.. 1003	4015-M3.5x9	80-T15		
AEMR-RD1003-D25-M12-L35-Z02-H	●	25	2	21	M12	35	12.5	5					
AEMR-RD1003-D25-M12-L35-Z03-H	●	25	3	21	M12	35	12.5	5					
AEMR-RD1003-D30-M16-L43-Z04-H	●	30	4	29	M16	43	17	5					
AEMR-RD1003-D32-M16-L43-Z04-H	●	32	4	29	M16	43	17	5					
AEMR-RD1003-D35-M16-L43-Z04-H	●	35	4	29	M16	43	17	5					
AEMR-RD1003-D40-M16-L43-Z05-H	●	40	5	29	M16	43	17	5					
AEMR-RD1003-D42-M16-L43-Z05-H	●	42	5	29	M16	43	17	5					
AEMR-RD10T3-D25-M12-L35-Z03-H	●	25	3	21	M12	35	12.5	5				RD.. 10T3	4015-M3.5x9
AEMR-RD10T3-D32-M16-L45-Z04-H	●	32	4	29	M16	45	17	5					
AEMR-RD1004-D25-M12-L35-Z03-H	●	25	3	21	M12	35	12.5	5	RD.. 1004	4515-M4x8			
AEMR-RD1004-D32-M16-L43-Z04-H	●	32	4	29	M16	43	17	5					
AEMR-RD12T3-D24-M12-L35-Z02-H	●	24	2	21	M12	35	12.5	6	RD.. 12T3	4015-M3.5x9	80-T15		
AEMR-RD12T3-D25-M12-L35-Z02-H	●	25	2	21	M12	35	12.5	6					
AEMR-RD12T3-D32-M16-L43-Z03-H	●	32	3	29	M16	43	17	6					
AEMR-RD12T3-D35-M16-L43-Z03-H	●	35	3	29	M16	43	17	6					
AEMR-RD12T3-D35-M16-L43-Z04-H	●	35	4	29	M16	43	17	6					
AEMR-RD12T3-D40-M16-L43-Z04-H	●	40	4	29	M16	43	17	6					
AEMR-RD12T3-D42-M16-L43-Z05-H	●	42	5	29	M16	43	17	6					
AEMR-RD1204-D32-M16-L43-Z03-H	●	32	3	29	M16	43	17	6				RD.. 1204	
AEMR-RD1204-D42-M16-L43-Z04-H	●	42	4	29	M16	43	17	6					
AEMR-RD1604-D32-M16-L43-Z02-H	●	32	2	29	M16	43	17	8	RD.. 1604	4015-M4.5x11	80-T15		
AEMR-RD1604-D40-M16-L43-Z02-H	●	40	2	29	M16	43	17	8					
AEMR-RD1604-D42-M16-L43-Z03-H	●	42	3	29	M16	43	17	8					

R: Sağ / Right / Rechts L: Sol/Left/Links

● Stokta / In Stock / Auf Lager ○ Stokta Yok / Non Stock Item / Kein Lagerartikel, Lieferzeit auf Anfrage  
ISO Ucuna Uygunudur. / Compatible with ISO Insert. Kompatibel mit ISO Wendepalten.

Sipariş Örneği/Ordering Example/Bestellbeispiel



1 ad./pcs./stück AEMR-RD0702-D15-M08-L23-Z02-H

Kesme Hesabı : S 367 / Cutting Calculation : P 367 / Schnittberechnung : 367

Sıkma Tork Değeri : S 367 / Tightening Torque : P 367 / Anzugsmoment : 367

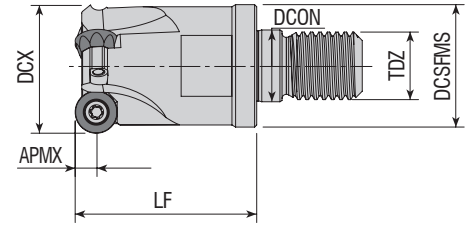



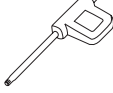

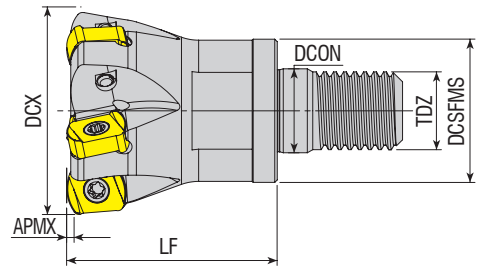

Takım Kodu Ordering Code Bestell-Bezeichnung	Stok Stock Lager	Takım Ölçüleri (mm) Dimension (mm) Abmessung (mm)							Kesici Uç Insert Wendeschneidplatte	Yedek Parçaları / Spare Parts / Ersatzteile	
		DCX	ZEFP	DCSFMS	TDZ	LF	DCON	APMX		Sıkma Vidası Screw Schraube	Tork Anahtar Torx Key Torx-Schlüssel
AEMR-QP10T3-D25-M12-L35-Z02-H	●	25	2	21	M12	35	12.5	5			
AEMR-QP10T3-D32-M16-L43-Z03-H	●	32	3	29	M16	43	17	5			

SMTM Ucuna Uygun. / Compatiple with SMTM Insert. Kompatibel mit SMTM Wendeplatten.

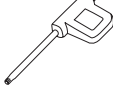

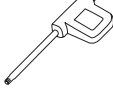
Takım Kodu Ordering Code Bestell-Bezeichnung	Stok Stock Lager	Takım Ölçüleri (mm) Dimension (mm) Abmessung (mm)							Kesici Uç Insert Wendeschneidplatte	Yedek Parçaları / Spare Parts / Ersatzteile				
		DCX	ZEFP	DCSFMS	TDZ	LF	DCON	APMX		Sıkma Vidası Screw Schraube	Tork Anahtar Torx Key Torx-Schlüssel			
AHFM-BL0603-D20-M10-L30-Z03-H	●	20	3	18	M10	30	10.5	1						
AHFM-BL0603-D32-M16-L40-Z05-H	●	32	5	29	M16	40	17	1				<b>BLMP 0603..</b>	3008-M2.5x6	80-T08
AHFM-BL0904-D32-M16-L40-Z04-H	●	32	4	29	M16	40	17	1.5						
AHFM-BL0904-D32-M16-L43-Z04-H	●	32	4	29	M16	43	17	1.5				<b>BLMP 0904..</b>	3010-M3.5x9	80-T10
AHFM-BL0904-D42-M16-L43-Z05-H	●	42	5	29	M16	43	17	1.5						

R: Sağ / Right / Rechts L: Sol/Left/Links

● Stokta / In Stock / Auf Lager ○ Stokta Yok / Non Stock Item / Kein Lagerartikel, Lieferzeit auf Anfrage

TGTC Ucuna Uygun. / Compatiple with TGTC Insert. Kompatibel mit TGTC Wendeplatten.

Sipariş Örneği/Ordering Example/Bestellbeispiel

1 ad./pcs./stück AEMR-QP10T3-D25-M12-L35-Z02-H

Kesme Hesabı : S 367 / Cutting Calculation : P 367 / Schnittberechnung : 367

Sıkma Tork Değeri : S 367 / Tightening Torque : P 367 / Anzugsmoment : 367

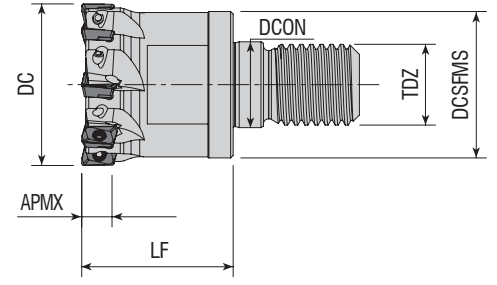

Takım Kodu Ordering Code Bestell-Bezeichnung	Stok Stock Lager	Takım Ölçüleri (mm) Dimension (mm) Abmessung (mm)							Kesici Uç Insert Wendeschneidplatte	Yedek Parçaları / Spare Parts / Ersatzteile	
		DC	ZEFP	DCSFMS	TDZ	LF	DCON	APMX		Sıkma Vidası Screw Schraube	Tork Anahtar Torx Key Torx-Schlüssel
AHFM-ED0702-D12-M06-L20-Z03	●	12	3	10	M06	20	6.5	6	EDMT 0702 JDMT 070204	3006-M1.8x4	80-T06
AHFM-ED0702-D16-M08-L25-Z04-H	●	16	4	14.75	M08	25	8.5	6			
AHFM-ED0702-D20-M10-L30-Z05-H	●	20	5	18	M10	30	10.5	6			
AHFM-ED0702-D25-M12-L30-Z06-H	●	25	6	21	M12	30	12.5	6			
AHFM-ED0702-D32-M16-L30-Z08-H	●	32	8	29	M16	30	17	6			

HTCH Ucuna Uygunudur. / Compatible with HTCH Insert. Kompatibel mit HTCH Wendeplatten.

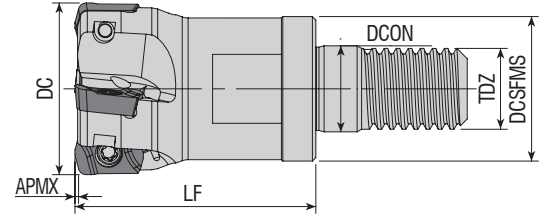

Takım Kodu Ordering Code Bestell-Bezeichnung	Stok Stock Lager	Takım Ölçüleri (mm) Dimension (mm) Abmessung (mm)							Kesici Uç Insert Wendeschneidplatte	Yedek Parçaları / Spare Parts / Ersatzteile	
		DC	ZEFP	DCSFMS	TDZ	LF	DCON	APMX		Sıkma Vidası Screw Schraube	Tork Anahtar Torx Key Torx-Schlüssel
AHFM-EP1003-D16-M08-L23-Z02-H	●	16	2	14.75	M08	23	8.5	1	EP. 1003.. ZPMT 1003.. YPHW 1003..	3008-M2.5x5	80-T08
AHFM-EP1003-D20-M10-L30-Z04-H	●	20	4	18	M10	30	10.5	1			
AHFM-EP1003-D25-M12-L35-Z04-H	●	25	4	21	M12	35	12.5	1			
AHFM-EP1003-D32-M16-L43-Z05-H	●	32	5	29	M16	43	17	1			
AHFM-EP1003-D35-M16-L43-Z05-H	●	35	5	29	M16	43	17	1			
AHFM-EP1003-D42-M16-L43-Z06-H	●	42	6	29	M16	43	17	1			

R: Sağ / Right / Rechts L: Sol/Left/Links

● Stokta / In Stock / Auf Lager ○ Stokta Yok / Non Stock Item / Kein Lagerartikel, Lieferzeit auf Anfrage  
DJT Ucuna Uygunudur. / Compatible with DJT Insert. Kompatibel mit DJT Wendeplatten.

Sipariş Örneği/Ordering Example/Bestellbeispiel

1 ad./pcs./stück AHFM-ED0702-D12-M06-L20-Z03

Kesme Hesabı : S 367 / Cutting Calculation : P 367 / Schnittberechnung : 367

Sıkma Tork Değeri : S 367 / Tightening Torque : P 367 / Anzugsmoment : 367



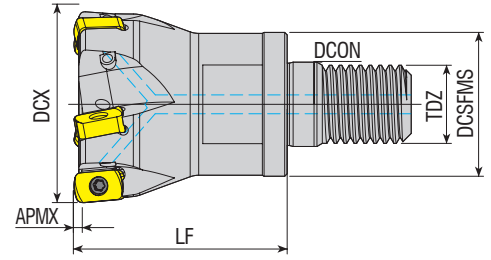

**Takım Kodu**  
**Ordering Code**  
**Bestell-Bezeichnung**

Takım Kodu Ordering Code Bestell-Bezeichnung	Stok Stock Lager		Takım Ölçüleri (mm) Dimension (mm) Abmessung (mm)					Kesici Uç Insert Wendeschneidplatte	Yedek Parçaları / Spare Parts / Ersatzteile				
	DCX	ZEP	DCSFMS	TDZ	LF	DCON	APMX		Sıkma Vidası Screw Schraube	Baskı Parçası Wedge Clamp Spannpratze	Baskı Vidası Clamp Screw Klemmschraube	Tork Anahtar Torx Key	
AHFM-EN1004-D16-M08-L23-Z02-H	●	16	2	14.75	M08	23	8.5	1	ENMU 1004..	3008-M2.5x5			80-T08
AHFM-EN1004-D20-M10-L30-Z03-H	●	20	3	18	M10	30	10.5	1					
AHFM-EN1004-D25-M12-L35-Z03-H	●	25	3	21	M12	35	12.5	1					
AHFM-EN1004-D25-M12-L35-Z04-H	●	25	4	21	M12	35	12.5	1					
AHFM-EN1004-D32-M16-L43-Z05-H	●	32	5	29	M16	43	17	1					
AHFM-EN1004-D35-M16-L43-Z05-H	●	35	5	29	M16	43	17	1					
AHFM-EN1004-D40-M16-L43-Z05-H	●	40	5	29	M16	43	17	1					
AHFM-EN1004-D42-M16-L43-Z05-H	●	42	5	29	M16	43	17	1					

R: Sağ / Right / Rechts L: Sol/Left/Links

● Stokta / In Stock / Auf Lager ○ Stokta Yok / Non Stock Item / Kein Lagerartikel, Lieferzeit auf Anfrage  
DJT Ucuna Uygunudur. / Compatiple with DJT Insert. Kompatibel mit DJT Wendepplatten.

Sipariş Örneği/Ordering Example/Bestellbeispiel

1 ad./pcs./stück AHFM-EN1004-D16-M08-L23-Z02-H

Kesme Hesabı : S 367 / Cutting Calculation : P 367 / Schnittberechnung : 367

Sıkma Tork Değeri : S 367 / Tightening Torque : P 367 / Anzugsmoment : 367



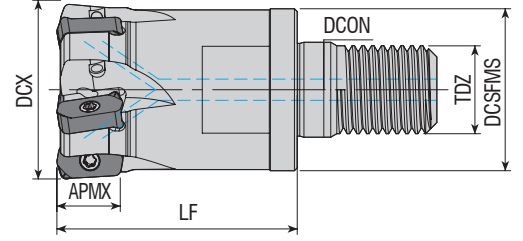

Takım Kodu Ordering Code Bestell-Bezeichnung	Stok Stock Lager	Takım Ölçüleri (mm) Dimension (mm) Abmessung (mm)						Kesici Uç Insert Wendeschneidplatte	Yedek Parçaları / Spare Parts / Ersatzteile				
		DCX	ZEP	DCSFMS	TDZ	LF	DCON		APMX	Sıkma Vidası Screw Schraube	Baskı Parçası Wedge Clamp Spannpratze	Baskı Vidası Clamp Screw Klemmschraube	Tork Anahtar Torx Key Torx-Schlüssel
AHFM-LN0303-D25-M12-L35-Z04-H	●	25	4	21	M12	35	12.5	12	LNMU 0303..	3008-M2.5x6	-	-	80-T08
AHFM-LN0303-D32-M16-L43-Z05-H	●	32	5	29	M16	43	17	12					
AHFM-LN0303-D42-M16-L43-Z06-H	●	42	6	29	M16	43	17	12					

TNGYL Ucuna Uygundur. / Compatible with TNGYL Insert. Kompatibel mit TNGYL Wendeplatten.

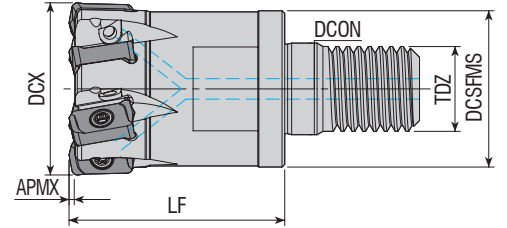

Takım Kodu Ordering Code Bestell-Bezeichnung	Stok Stock Lager	Takım Ölçüleri (mm) Dimension (mm) Abmessung (mm)						Kesici Uç Insert Wendeschneidplatte	Yedek Parçaları / Spare Parts / Ersatzteile				
		DCX	ZEP	DCSFMS	TDZ	LF	DCON		APMX	Sıkma Vidası Screw Schraube	Baskı Parçası Wedge Clamp Spannpratze	Baskı Vidası Clamp Screw Klemmschraube	Tork Anahtar Torx Key Torx-Schlüssel
AHFM-L003-D20-M10-L30-Z04-H-F	●	20	4	18	M10	30	10.5	1	LOGU 0303..	1108-M3x6.8	-	-	80-T08
AHFM-L003-D25-M12-L35-Z04-H-F	●	25	4	21	M12	35	12.5	1					
AHFM-L003-D25-M12-L35-Z04-H	●	25	4	21	M12	35	12.5	1					
AHFM-L003-D32-M16-L40-Z05-H-F	●	32	5	29	M16	40	17	1					
AHFM-L003-D32-M16-L40-Z05-H	●	32	5	29	M16	40	17	1					
AHFM-L003-D32-M16-L40-Z06-H-F	●	32	6	29	M16	40	17	1					
AHFM-L003-D32-M16-L40-Z06-H	●	32	6	29	M16	40	17	1					
AHFM-L003-D35-M16-L40-Z05-H	●	35	5	29	M16	40	17	1					
AHFM-L003-D35-M16-L40-Z06-H	●	35	6	29	M16	40	17	1					
AHFM-L003-D42-M16-L40-Z05-H	●	42	5	29	M16	40	17	1					
AHFM-L003-D42-M16-L40-Z06-H	●	42	6	29	M16	40	17	1					

R: Sağ / Right / Rechts L: Sol/Left/Links

● Stokta / In Stock / Auf Lager ○ Stokta Yok / Non Stock Item / Kein Lagerartikel, Lieferzeit auf Anfrage  
KYCR Ucuna Uygundur. / Compatible with KYCR Insert. Kompatibel mit KYCR Wendeplatten.

F: Eksen ve Radyal Salgı Değeri 0,02 mm İçindedir. / F: Axial and Radial Runout Value is within 0,02 mm.

F: Der axiale und radiale Rundlaufwert liegt innerhalb von 0,02 mm.

Sipariş Örneği/Ordering Example/Bestellbeispiel

1 ad./pcs./stück AHFM-LN0303-D25-M12-L35-Z04-H

Kesme Hesabı : S 367 / Cutting Calculation : P 367 / Schnittberechnung : 367

Sıkma Tork Değeri : S 367 / Tightening Torque : P 367 / Anzugsmoment : 367

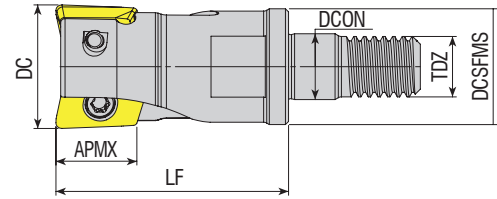
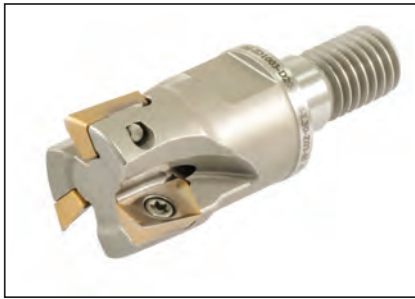

Takım Kodu Ordering Code Bestell-Bezeichnung	Stok Stock Lager	Takım Ölçüleri (mm) Dimension (mm) Abmessung (mm)							Kesici Uç Insert Wendeschneidplatte	Yedek Parçaları / Spare Parts / Ersatzteile		
		DC	ZEFP	DCSFMS	TDZ	LF	DCON	APMX		Sıkma Vidası Screw Schraube	Tork Anahtar Torx Key Torx-Schlüssel	
AHFM-JD1003-D16-M08-L30-Z02-H	●	16	2	14.75	M08	30	8.5	9				
AHFM-JD1003-D20-M10-L30-Z03-H	●	20	3	18	M10	30	10.5	9	JDMT 1003..	3008-M2.5x6	80-T08	

HTCH Ucuna Uygundur. / Compatible with HTCH Insert. Kompatibel mit HTCH Wendeplatten.

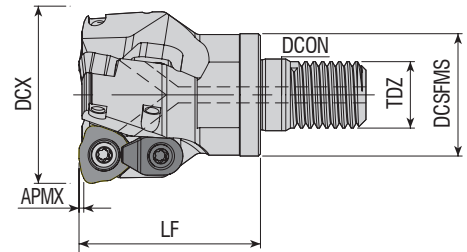

Takım Kodu Ordering Code Bestell-Bezeichnung	Stok Stock Lager	Takım Ölçüleri (mm) Dimension (mm) Abmessung (mm)							Kesici Uç Insert Wendeschneidplatte	Yedek Parçaları / Spare Parts / Ersatzteile				
		DCX	ZEFP	DCSFMS	TDZ	LF	DCON	APMX		Sıkma Vidası Screw Schraube	Baskı Parçası Wedge Clamp Spannpratze	Baskı Vidası Clamp Screw Klemmschraube	Tork Anahtar Torx Key Torx-Schlüssel	
AHFMC-JD1204-D32-M16-L43-Z02-H	●	32	2	29	M16	43	17	1.5						
AHFMC-JD1204-D42-M16-L43-Z03-H	●	42	3	29	M16	43	17	1.5	JDMW 1204..	4615-M4x11	ACK-05	4015-M4x11	80-T15	

R: Sağ / Right / Rechts L: Sol/Left/Links

● Stokta / In Stock / Auf Lager ○ Stokta Yok / Non Stock Item / Kein Lagerartikel, Lieferzeit auf Anfrage

MTSBSH Ucuna Uygundur. / Compatible with MTSBSH Insert. Kompatibel mit MTSBSH Wendeplatten.

Sipariş Örneği/Ordering Example/Bestellbeispiel  
1 ad./pcs./stück AHFM-JD1003-D16-M08-L30-Z02-H

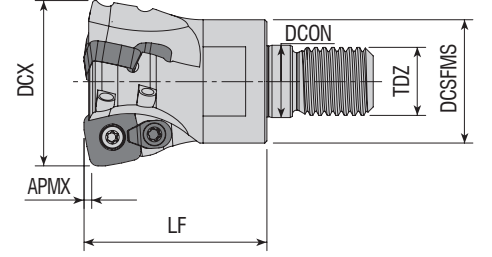

Takım Kodu Ordering Code Bestell-Bezeichnung	Stok Stock Lager	Takım Ölçüleri (mm) Dimension (mm) Abmessung (mm)							Kesici Uç Insert Wendeschneidplatte	Yedek Parçaları / Spare Parts / Ersatzteile			
		DCX	ZEPF	DCSFMS	TDZ	LF	DCON	APMX		Sıkma Vidası Screw Schraube	Baskı Parçası Wedge Clamp Spannpratze	Baskı Vidası Clamp Screw Klemmschraube	Tork Anahtar Torx Key Torx-Schlüssel
AHFM-SD06T2-D16-M08-L23-Z02-H	●	16	2	14.75	M08	23	8.5	0.8	SD.. 06T2..	3007-M2.2x5	-	-	80-T07
AHFM-SD06T2-D20-M10-L30-Z03-H	●	20	3	18	M10	30	10.5	0.8					
AHFM-SD06T2-D25-M12-L35-Z04-H	●	25	4	21	M12	35	12.5	0.8					
AHFMC-SD09T3-D25-M12-L30-Z02-H	●	25	2	22	M12	30	12.5	1.4	SD.. 09T3..	3010-M3.5x9	ACK-15	1510-M3.5x9	80-T10
AHFMC-SD09T3-D32-M16-L43-Z03-H	●	32	3	29	M16	43	17	1.4					
AHFMC-SD09T3-D35-M16-L43-Z03-H	●	35	3	29	M16	43	17	1.4					
AHFMC-SD09T3-D40-M16-L43-Z04-H	●	40	4	29	M16	43	17	1.4	SD.. 1204..	4015-M4x9	-	4015-M3.5X11	80-T15
AHFMC-SD1204-D32-M16-L43-Z02-H	●	32	2	29	M16	43	17	1.8					
AHFMC-SD1204-D40-M16-L43-Z03-H	●	40	3	29	M16	43	17	1.8					

ZCC Ucuna Uygundur. / Compatible with ZCC Insert. Kompatibel mit ZCC Wendeplatten.

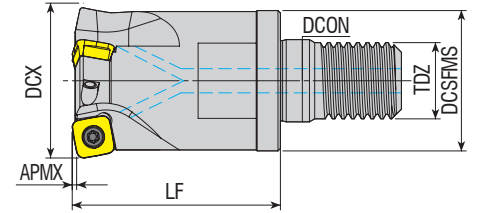

Takım Kodu Ordering Code Bestell-Bezeichnung	Stok Stock Lager	Takım Ölçüleri (mm) Dimension (mm) Abmessung (mm)							Kesici Uç Insert Wendeschneidplatte	Yedek Parçaları / Spare Parts / Ersatzteile			
		DCX	ZEPF	DCSFMS	TDZ	LF	DCON	APMX		Sıkma Vidası Screw Schraube	Baskı Parçası Wedge Clamp Spannpratze	Baskı Vidası Clamp Screw Klemmschraube	Tork Anahtar Torx Key Torx-Schlüssel
AHFM-S00803-D20-M10-L30-Z02-H	●	20	2	18	M10	30	10.5	1	SOMW 0803..	4010-M3X8	-	-	80-T10
AHFM-S00803-D25-M12-L35-Z03-H	●	25	3	22	M12	35	12.5	1					
AHFM-S00803-D32-M16-L43-Z03-H	●	32	3	29	M16	43	17	1					
AHFM-S00803-D32-M16-L43-Z04-H	●	32	4	29	M16	43	17	1					
AHFM-S00803-D40-M16-L43-Z04-H	●	40	4	29	M16	43	17	1					

R: Sağ / Right / Rechts L: Sol/Left/Links

● Stokta / In Stock / Auf Lager ○ Stokta Yok / Non Stock Item / Kein Lagerartikel, Lieferzeit auf Anfrage

KPTK Ucuna Uygundur. / Compatible with KPTK Insert. Kompatibel mit KPTK Wendeplatten.

Sipariş Örneği/Ordering Example/Bestellbeispiel

1 ad./pcs./stück AHFM-SD06T2-D16-M08-L23-Z02-H



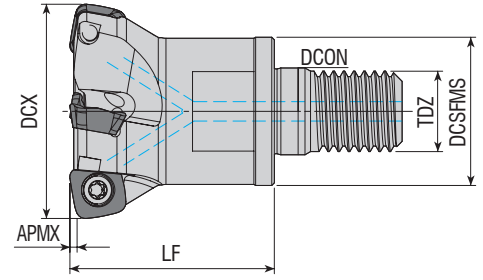

Takım Kodu Ordering Code Bestell-Bezeichnung	Stok Stock Lager	Takım Ölçüleri (mm) Dimension (mm) Abmessung (mm)							Kesici Uç Insert Wendeschneidplatte	Yedek Parçaları / Spare Parts / Ersatzteile			
		DCX	ZEFP	DCSFMS	TDZ	LF	DCON	APMX		Sıkma Vidası Screw Schraube	Baskı Parçası Wedge Clamp Spannpratze	Baskı Vidası Clamp Screw Klemmschraube	Tork Anahtar Torx Key Torx-Schlüssel
AHFM-SO1004-D32-M16-L40-Z03-H	●	32	3	29	M16	40	17	1.5	SOMT 1004..	4015-M4x9	-	-	80-T15
AHFM-SO1004-D40-M16-L40-Z04-H	●	40	4	29	M16	40	17	1.5					
AHFM-SO1004-D42-M16-L40-Z04-H	●	42	4	29	M16	40	17	1.5					

KYCR Ucuna Uygundur. / Compatible with KYCR Insert. Kompatibel mit KYCR Wendeplatten.

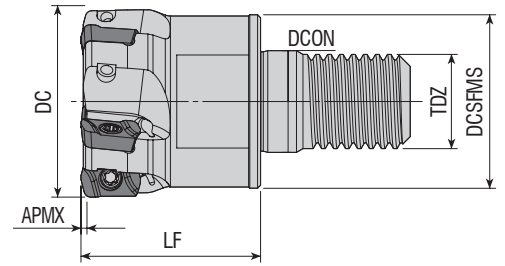

Takım Kodu Ordering Code Bestell-Bezeichnung	Stok Stock Lager	Takım Ölçüleri (mm) Dimension (mm) Abmessung (mm)							Kesici Uç Insert Wendeschneidplatte	Yedek Parçaları / Spare Parts / Ersatzteile			
		DC	ZEFP	DCSFMS	TDZ	LF	DCON	APMX		Sıkma Vidası Screw Schraube	Baskı Parçası Wedge Clamp Spannpratze	Baskı Vidası Clamp Screw Klemmschraube	Tork Anahtar Torx Key Torx-Schlüssel
AHFM-YP1003-D16-M08-L23-Z02-F	●	16	2	14.75	M08	23	8.5	1	EP. 1003.. ZPMT 1003.. YPHW 1003..	3008-M2.5x5	-	-	80-T08
AHFM-YP1003-D16-M08-L23-Z02-H-F	●	16	2	14.75	M08	23	8.5	1					
AHFM-YP1003-D17-M08-L23-Z02-H	●	17	2	14.75	M08	23	8.5	1					
AHFM-YP1003-D17-M08-L23-Z02-H-F	●	17	2	14.75	M08	23	8.5	1					
AHFM-YP1003-D20-M10-L30-Z03-H	●	20	3	18	M10	30	10.5	1					
AHFM-YP1003-D20-M10-L30-Z03-H-F	●	20	3	18	M10	30	10.5	1					
AHFM-YP1003-D20-M10-L30-Z04-H	●	20	4	18	M10	30	10.5	1					
AHFM-YP1003-D20-M10-L30-Z04-F	●	20	4	18	M10	30	10.5	1					
AHFM-YP1003-D21-M10-L30-Z03-H	●	21	3	18	M10	30	10.5	1					
AHFM-YP1003-D21-M10-L30-Z03-H-F	●	21	3	18	M10	30	10.5	1					
AHFM-YP1003-D25-M12-L35-Z04-H	●	25	4	21	M12	35	12.5	1					
AHFM-YP1003-D25-M12-L35-Z04-F	●	25	4	21	M12	35	12.5	1					
AHFM-YP1003-D25-M12-L35-Z04-H-F	●	25	4	21	M12	35	12.5	1					
AHFM-YP1003-D26-M12-L35-Z04-H-F	●	26	4	21	M12	35	12.5	1					
AHFM-YP1003-D32-M16-L30-Z05-F	●	32	5	29	M16	30	17	1					
AHFM-YP1003-D32-M16-L43-Z05-H-F	●	32	5	29	M16	43	17	1					
AHFM-YP1003-D40-M16-L43-Z06-H-F	●	40	6	29	M16	43	17	1					
AHFM-YP1003-D42-M16-L43-Z06-H-F	●	42	6	29	M16	43	17	1					

R: Sağ / Right / Rechts L: Sol/Left/Links

● Stokta / In Stock / Auf Lager ○ Stokta Yok / Non Stock Item / Kein Lagerartikel, Lieferzeit auf Anfrage

DJT Ucuna Uygundur. / Compatible with DJT Insert. Kompatibel mit DJT Wendeplatten.

Çap Ölçüsü - 0,02 mm Olarak üretiliyor. F: ± 0,02 mm Demektir. Ör: Ø16 Takım 15,98 ± 0,02 mm yani 16,00 mm - 15,96 mm Olmalıdır.

Diameter Size is produced as - 0.02 mm. F: means ± 0,02 mm. For example: Ø16 tool 15,98 ± 0,02 mm, it means that it should be 16,00 mm - 15,96 mm.

Durchmesser - Es wird mit -0,02 mm hergestellt. Das heißt F: ± 0,02 mm. Zum Beispiel: Der Ø16-Satz sollte 15,98 ± 0,02 mm, 16,00 mm - 15,96 mm betragen.

Sipariş Örneği/Ordering Example/Bestellbeispiel

1 ad./pcs./stück AHFM-SO1004-D32-M16-L40-Z03-H

Kesme Hesabı : S 367 / Cutting Calculation : P 367 / Schnittberechnung : 367

Sıkma Tork Değeri : S 367 / Tightening Torque : P 367 / Anzugsmoment : 367

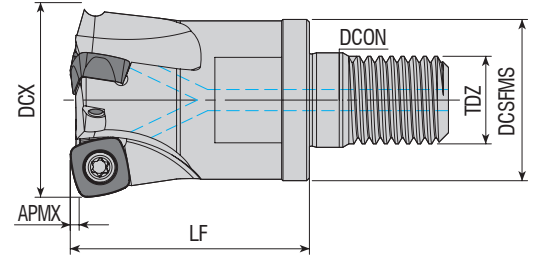

Takım Kodu Ordering Code Bestell-Bezeichnung	Stok Stock Lager	Takım Ölçüleri (mm) Dimension (mm) Abmessung (mm)							Kesici Uç Insert Wendeschneidplatte	Yedek Parçaları / Spare Parts / Ersatzteile			
		DCX	ZEPF	DCSFMS	TDZ	LF	DCON	APMX		Sıkma Vidası Screw Schraube	Baskı Parçası Wedge Clamp Spannpratze	Baskı Vidası Clamp Screw Klemmschraube	Tork Anahtar Torx Key Torx-Schlüssel
AHFM-SP1004-D25-M12-L35-Z02-H	●	25	2	21	M12	35	12.5	1	SPNW 1004..		-	-	80-T15
AHFM-SP1004-D32-M16-L43-Z03-H	●	32	3	29	M16	43	17	1.5					
AHFM-SP1004-D35-M16-L43-Z03-H	●	35	3	29	M16	43	17	1.5					
AHFM-SP1004-D42-M16-L43-Z04-H	●	42	4	29	M16	43	17	1.5					

DJT Ucuna Uygunudur. / Compatible with DJT Insert. Kompatibel mit DJT Wendeplatten.

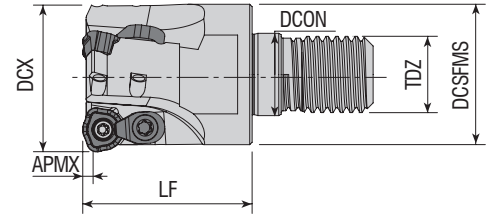

Takım Kodu Ordering Code Bestell-Bezeichnung	Stok Stock Lager	Takım Ölçüleri (mm) Dimension (mm) Abmessung (mm)							Kesici Uç Insert Wendeschneidplatte	Yedek Parçaları / Spare Parts / Ersatzteile			
		DCX	ZEPF	DCSFMS	TDZ	LF	DCON	APMX		Sıkma Vidası Screw Schraube	Baskı Parçası Wedge Clamp Spannpratze	Baskı Vidası Clamp Screw Klemmschraube	Tork Anahtar Torx Key Torx-Schlüssel
AHFM-SP1004-D25-M12-L35-Z02-H	●	25	2	21	M12	35	12.5	1.5	WDMT 0804..		ACK-15	4010-M3x8	80-T10
AHFM-SP1004-D32-M16-L43-Z03-H	●	32	3	29	M16	35	17	1.5					

R: Sağ / Right / Rechts L: Sol/Left/Links

● Stokta / In Stock / Auf Lager ○ Stokta Yok / Non Stock Item / Kein Lagerartikel, Lieferzeit auf Anfrage

SMTM Ucuna Uygunudur. / Compatible with SMTM Insert. Kompatibel mit SMTM Wendeplatten.

Sipariş Örneği/Ordering Example/Bestellbeispiel

1 ad./pcs./stück AHFM-SP1004-D25-M12-L35-Z02-H

Kesme Hesabı : S 367 / Cutting Calculation : P 367 / Schnittberechnung : 367

Sıkma Tork Değeri : S 367 / Tightening Torque : P 367 / Anzugsmoment : 367

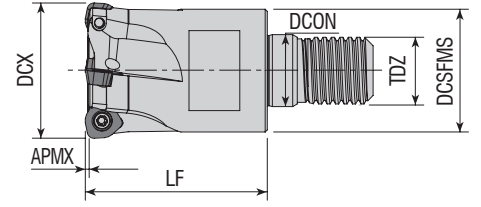

Takım Kodu Ordering Code Bestell-Bezeichnung	Stok Stock Lager	Takım Ölçüleri (mm) Dimension (mm) Abmessung (mm)							Kesici Uç Insert Wendeschneidplatte	Yedek Parçaları / Spare Parts / Ersatzteile				
		DCX	ZEP	DCSFMS	TDZ	LF	DCON	APMX		Sıkma Vidası Screw Schraube	Baskı Parçası Wedge Clamp Spannpratze	Baskı Vidası Clamp Screw Klemmschraube	Tork Anahtar Torx Key Torx-Schlüssel	
AHFM-WD0503D-D20-M10-L30-Z02-H	●	20	2	18	M10	30	10.5	1.25	WDMT 0503..	4010-M3x6	-	-	80-T10	
AHFM-WD0503D-D25-M12-L35-Z03-H	●	25	3	21	M12	35	12.5	1.25		4010-M3x8	-	-		
AHFM-WD0503D-D32-M16-L43-Z04-H	●	32	4	29	M16	43	17	1.25		-	-	-		
AHFM-WD0503D-D40-M16-L43-Z05-H	●	40	5	29	M16	43	17	1.25		-	-	-		
AHFMC-WD06T3D-D35-M16-L43-Z03-H	●	35	3	29	M16	43	17	1.5	WDHW 06T3..	3015-M3.5x9	ACK-15	4015-M3.5x11	80-T15	
AHFMC-WD0805D-D32-M16-L43-Z02-H	●	32	2	29	M16	43	17	2	WDHW 0805..	4020-M4.5x10	ACK-19	4020-M4.5x12		

DJT Ucuna Uygundur. / Compatible with DJT Insert. Kompatibel mit DJT Wendeplatten.

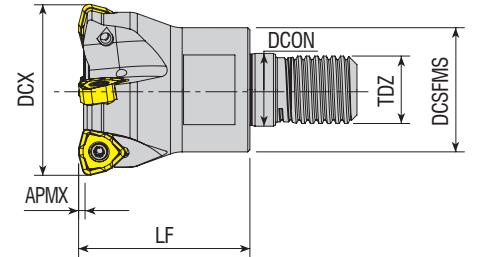

Takım Kodu Ordering Code Bestell-Bezeichnung	Stok Stock Lager	Takım Ölçüleri (mm) Dimension (mm) Abmessung (mm)							Kesici Uç Insert Wendeschneidplatte	Yedek Parçaları / Spare Parts / Ersatzteile		
		DCX	ZEP	DCSFMS	TDZ	LF	DCON	APMX		Sıkma Vidası Screw Schraube	Tork Anahtar Torx Key Torx-Schlüssel	
AHFM-WN09T3-D32-M16-L40-Z03-H	●	32	3	29	M16	40	17	1.5	WMMX 09T3..	4010-M3x8	80-T10	
AHFM-WN09T3-D40-M16-L40-Z04-H	●	40	4	29	M16	40	17	1.5				

R: Sağ / Right / Rechts L: Sol/Left/Links

● Stokta / In Stock / Auf Lager ○ Stokta Yok / Non Stock Item / Kein Lagerartikel, Lieferzeit auf Anfrage

KRLY Ucuna Uygundur. / Compatible with KRLY Insert. Kompatibel mit KRLY Wendeplatten.

Sipariş Örneği/Ordering Example/Bestellbeispiel

1 ad./pcs./stück AHFM-WD0503D-D20-M10-L30-Z02-H

Kesme Hesabı : S 367 / Cutting Calculation : P 367 / Schnittberechnung : 367

Sıkma Tork Değeri : S 367 / Tightening Torque : P 367 / Anzugsmoment : 367

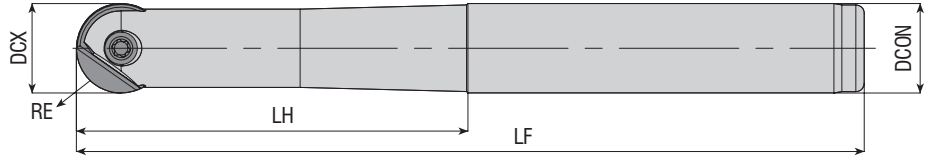

Takım Kodu Ordering Code Bestell-Bezeichnung	Stok Stock Lager	Takım Ölçüleri (mm) Dimension (mm) Abmessung (mm)					Kesici Uç Insert Wendeschneidplatte	Yedek Parçaları / Spare Parts / Ersatzteile	
		DCX	RE	DCON	LF	LH		Sıkma Vidası Screw Schraube	Tork Anahtar Torx Key Torx-Schlüssel
APMR-BNM12-D12-C12-L130	●	12	6	12	130	32		1210-M3.5x9.6	80-T10
APMR-BNM16-D16-C16-L175	●	16	8	16	175	70		1215-M4x13.5	80-T15
APMR-BNM16-D16-C16-L200	●	16	8	16	200	100		1220-M5x0.5x15	80-T20
APMR-BNM20-D20-C20-L160	●	20	10	20	160	70			
APMR-BNM20-D20-C20-L200	●	20	10	20	200	100			
APMR-BNM20-D20-C20-L250	●	20	10	20	250	150		1220-M6x0.75x20	80-T20
APMR-BNM25-D25-C25-L160	●	25	12.5	25	160	70			
APMR-BNM25-D25-C25-L200	●	25	12.5	25	200	100			
APMR-BNM25-D25-C25-L250	●	25	12.5	25	250	150			

DJT Ucuna Uygunudur. / Compatible with DJT Insert. Kompatibel mit DJT Wendeplatten.

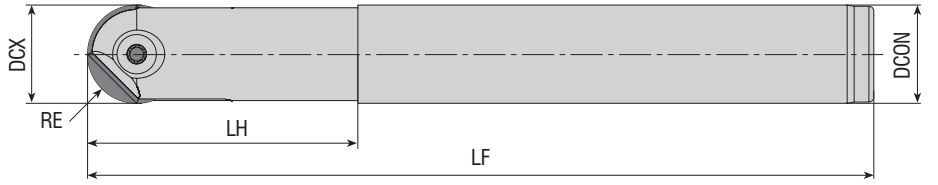

Takım Kodu Ordering Code Bestell-Bezeichnung	Stok Stock Lager	Takım Ölçüleri (mm) Dimension (mm) Abmessung (mm)					Kesici Uç Insert Wendeschneidplatte	Yedek Parçaları / Spare Parts / Ersatzteile	
		DCX	RE	DCON	LF	LH		Sıkma Vidası Screw Schraube	Tork Anahtar Torx Key Torx-Schlüssel
APMR-RO12-D12-C12-L120	●	12	6	12	120	35		1215-M4x0.5x9	80-T15
APMR-RO12-D12-C16-L160	●	12	6	16	160	50			
APMR-RO16-D16-C16-L160	●	16	8	16	160	45		1220-M5x0.5x12	80-T20
APMR-RO16-D16-C16-L200	●	16	8	16	200	45			
APMR-RO16-D16-C20-L200	●	16	8	20	200	65			
APMR-RO20-D20-C20-L160	●	20	10	20	160	55		1220-M5x0.5x15	80-T20
APMR-RO20-D20-C20-L200	●	20	10	20	200	55			
APMR-RO20-D20-C25-L220	●	20	10	25	220	80			

R: Sağ / Right / Rechts L: Sol/Left/Links

● Stokta / In Stock / Auf Lager ○ Stokta Yok / Non Stock Item / Kein Lagerartikel, Lieferzeit auf Anfrage

ZCC Ucuna Uygunudur. / Compatible with ZCC Insert. Kompatibel mit ZCC Wendeplatten.

Sipariş Örneği/Ordering Example/Bestellbeispiel

1 ad./pcs./stück APMR-BNM12-D12-C12-L130

Kesme Hesabı : S 367 / Cutting Calculation : P 367 / Schnittberechnung : 367



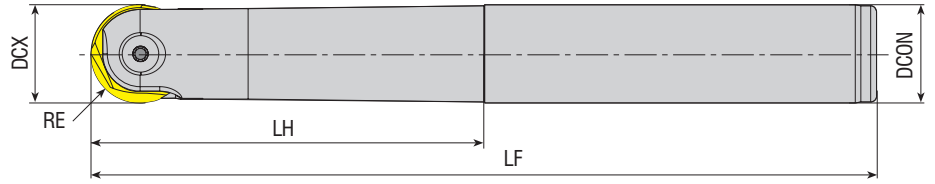

Takım Kodu Ordering Code Bestell-Bezeichnung	Stok Stock Lager	Takım Ölçüleri (mm) Dimension (mm) Abmessung (mm)					Kesici Uç Insert Wendeschneidplatte	Yedek Parçaları / Spare Parts / Ersatzteile	
		DCX	RE	DCON	LF	LH		Sıkma Vidası Screw Schraube	Tork Anahtar Torx Key Torx-Schlüssel
APMR-P3208-D08-C10-L110	●	8	4	10	110	25		1208-M3x7	80-T08
APMR-P3210-D10-C10-L130	●	10	5	10	130	30		1215-M4x0.5x9	80-T15
APMR-P3210-D10-C12-L130	●	10	5	12	130	30		1220-M5x0.5x9	80-T20
APMR-P3212-D12-C12-L130	●	12	6	12	130	32		1220-M5x0.5x12	
APMR-P3216-D16-C16-L175	●	16	8	16	175	75		1220-M5x0.5x15	
APMR-P3220-D20-C20-L200	●	20	10	20	200	100		1220-M6x0.75x20	AAL-05-4
APMR-P3225-D25-C25-L200	●	25	12.5	25	200	100		1204-M8x0.75x26	
APMR-P3232-D32-C32-L200	●	32	16	32	200	100			

WLTR Ucuna Uygun. / Compatible with WLTR Insert. Kompatibel mit WLTR Wendeplatten.

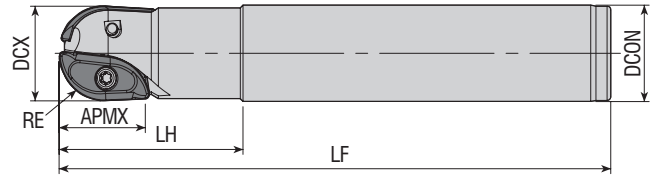

Takım Kodu Ordering Code Bestell-Bezeichnung	Stok Stock Lager	Takım Ölçüleri (mm) Dimension (mm) Abmessung (mm)						Kesici Uç Insert Wendeschneidplatte	Yedek Parçaları / Spare Parts / Ersatzteile	
		DCX	RE	DCON	LF	LH	APMX		Sıkma Vidası Screw Schraube	Tork Anahtar Torx Key Torx-Schlüssel
APMR-XP16-D16-C16-L150	●	16	8	16	150	40	16		3008-M2.5x6	80-T08
APMR-XP20-D20-C20-L150	●	20	10	20	150	50	20		3010-M3.5x7	80-T10
APMR-XP25-D25-C25-L150	●	25	12.5	25	150	50	25		4015-M4x9	80-T15

R: Sağ / Right / Rechts L: Sol/Left/Links

● Stokta / In Stock / Auf Lager ○ Stokta Yok / Non Stock Item / Kein Lagerartikel, Lieferzeit auf Anfrage

ZCC Ucuna Uygun. / Compatible with ZCC Insert. Kompatibel mit ZCC Wendeplatten.

Sipariş Örneği/Ordering Example/Bestellbeispiel

1 ad./pcs./stück APMR-P3208-D08-C10-L110

Kesme Hesabı : S 367 / Cutting Calculation : P 367 / Schnittberechnung : 367

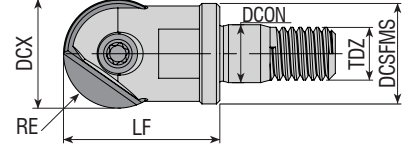

Takım Kodu Ordering Code Bestell-Bezeichnung	Stok Stock Lager	Takım Ölçüleri (mm) Dimension (mm) Abmessung (mm)						Kesici Uç Insert Wendeschneidplatte	Yedek Parçaları / Spare Parts / Ersatzteile		
		DCX	RE	DCSFMS	TDZ	LF	DCON		Sıkma Vidası Screw Schraube	Tork Anahtar Torx Key Torx-Schlüssel	
APMR-BNM12-D12-M06-L20	●	12	6	11	M06	20	6.5				
APMR-BNM16-D16-M08-L23	●	16	8	14.75	M08	23	8.5				
APMR-BNM20-D20-M10-L30	●	20	10	18	M10	30	10.5				

DJT Ucuna Uygundur. / Compatible with DJT Insert. Kompatibel mit DJT Wendeplatten.

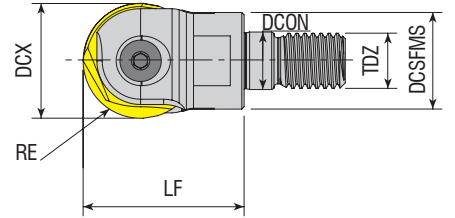

Takım Kodu Ordering Code Bestell-Bezeichnung	Stok Stock Lager	Takım Ölçüleri (mm) Dimension (mm) Abmessung (mm)						Kesici Uç Insert Wendeschneidplatte	Yedek Parçaları / Spare Parts / Ersatzteile		
		DCX	RE	DCSFMS	TDZ	LF	DCON		Sıkma Vidası Screw Schraube	Tork Anahtar Torx Key Torx-Schlüssel	
APMR-P3216-D16-M08-L25	●	16	8	14	M08	25	8.5				
APMR-P3220-D20-M10-L30	●	20	10	18	M10	30	10.5				
APMR-P3225-D25-M12-L35	●	25	12.5	21	M12	35	12.5				
APMR-P3232-D32-M16-L43	●	32	16	30	M16	43	17				

R: Sağ / Right / Rechts L: Sol/Left/Links

● Stokta / In Stock / Auf Lager ○ Stokta Yok / Non Stock Item / Kein Lagerartikel, Lieferzeit auf Anfrage

WLTR Ucuna Uygundur. / Compatible with WLTR Insert. Kompatibel mit WLTR Wendeplatten.

Sipariş Örneği/Ordering Example/Bestellbeispiel



1 ad./pcs./stück APMR-BNM12-D12-M06-L20

Kesme Hesabı : S 367 / Cutting Calculation : P 367 / Schnittberechnung : 367

Sıkma Tork Değeri : S 367 / Tightening Torque : P 367 / Anzugsmoment : 367

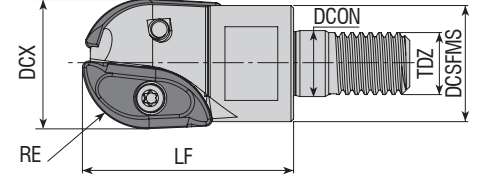



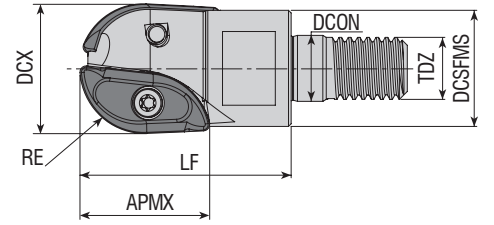

Takım Kodu Ordering Code Bestell-Bezeichnung	Stok Stock Lager	Takım Ölçüleri (mm) Dimension (mm) Abmessung (mm)						Kesici Uç Insert Wendeschneidplatte	Yedek Parçaları / Spare Parts / Ersatzteile	
		DCX	RE	DCSFMS	TDZ	LF	DCON		Sıkma Vidası Screw Schraube	Tork Anahtar Torx Key Torx-Schlüssel
APMR-SWB225-D25-M12-L35	●	25	12.5	23.5	M12	35	12.5			
APMR-SWB230-D30-M16-L43	●	30	15	28	M16	43	17			
APMR-SWB232-D32-M16-L43	●	32	16	30	M16	43	17			

DJT Ucuna Uygundur. / Compatible with DJT Insert. Kompatibel mit DJT Wendeplatten.



Takım Kodu Ordering Code Bestell-Bezeichnung	Stok Stock Lager	Takım Ölçüleri (mm) Dimension (mm) Abmessung (mm)							Kesici Uç Insert Wendeschneidplatte	Yedek Parçaları / Spare Parts / Ersatzteile	
		DCX	RE	DCSFMS	TDZ	LF	APMX	DCON		Sıkma Vidası Screw Schraube	Tork Anahtar Torx Key Torx-Schlüssel
APMR-XP16-D16-M08-L25	●	16	8	14.75	M08	25	16	8.5			
APMR-XP20-D20-M10-L30	●	20	10	18	M10	30	20	10.5			
APMR-XP25-D25-M12-L40	●	25	12.5	22	M12	40	25	12.5			

R: Sağ / Right / Rechts L: Sol/Left/Links

● Stokta / In Stock / Auf Lager ○ Stokta Yok / Non Stock Item / Kein Lagerartikel, Lieferzeit auf Anfrage

ZCC Ucuna Uygundur. / Compatible with ZCC Insert. Kompatibel mit ZCC Wendeplatten.

Sipariş Örneği/Ordering Example/Bestellbeispiel

1 ad./pcs./stück APMR-SWB225-D25-M12-L35

Kesme Hesabı : S 367 / Cutting Calculation : P 367 / Schnittberechnung : 367

Sıkma Tork Değeri : S 367 / Tightening Torque : P 367 / Anzugsmoment : 367

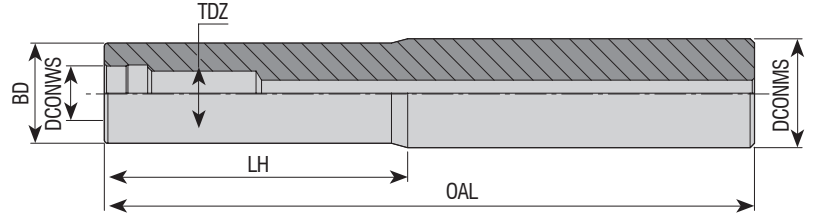

Takım Kodu Ordering Code Bestell-Bezeichnung	Stok Stock Lager	Takım Ölçüleri (mm) Dimension (mm) Abmessung (mm)					
		DCONMS	TDZ	DCONWS	BD	OAL	LH
AVTT-D13-C16-M08-L100-H	●	16	M08	8.5	13	100	40
AVTT-D15-C16-M08-L130-H	●	16	M08	8.5	15	130	70
AVTT-D18-C20-M10-L130-H	●	20	M10	10.5	18	130	70
AVTT-D18-C20-M10-L160-H	●	20	M10	10.5	18	160	80
AVTT-D23-C25-M12-L150-H	●	25	M12	12.5	23	150	70
AVTT-D23-C25-M12-L200-H	●	25	M12	12.5	23	200	100
AVTT-D23-C25-M12-L250-H	●	25	M12	12.5	23	250	150
AVTT-D30-C32-M16-L150-H	●	32	M16	17	30	150	70
AVTT-D30-C32-M16-L200-H	●	32	M16	17	30	200	100
AVTT-D30-C32-M16-L250-H	●	32	M16	17	30	250	150
AVTT-D30-C32-M16-L300-H	●	32	M16	17	30	300	200

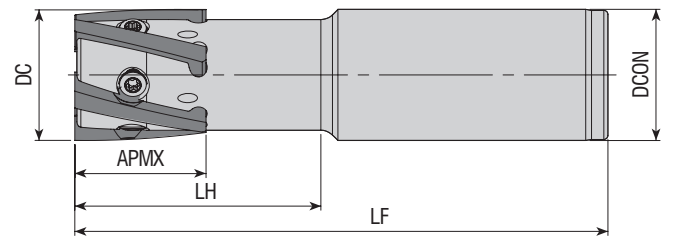

Takım Kodu Ordering Code Bestell-Bezeichnung	Stok Stock Lager	Takım Ölçüleri (mm) Dimension (mm) Abmessung (mm)						Kesici Uç Insert Wendeschneidplatte	Yedek Parçaları / Spare Parts / Ersatzteile		
		DC	ZEFP	DCON	LF	LH	APMX		Sıkma Vidası Screw Schraube	Tork Anahtar Torx Key Torx-Schlüssel	
ATM-H23-D23-C25-L100-Z02-H	●	23	2	25	100	30	27	H23	1015-M4x8	80-T15	
ATM-H32-D32-C32-L130-Z05-H	●	32	5	32	130	35	32	H32	1720-U8-32x10	80-T20	

CPT Ucuna Uygundur. / Compatible with CPT Insert. Kompatibel mit CPT Wendepfatten.

Sipariş Örneği/Ordering Example/Bestellbeispiel  
1 ad./pcs./stück AVTT-D13-C16-M08-L100-H

Kesme Hesabı : S 367 / Cutting Calculation : P 367 / Schnittberechnung : 367



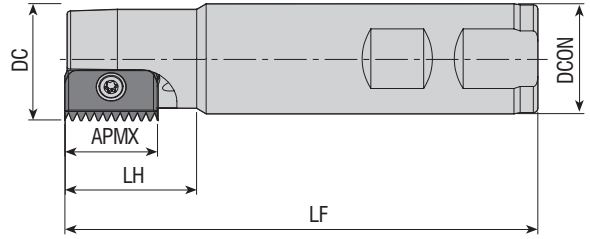

Takım Kodu Ordering Code Bestell-Bezeichnung	Stok Stock Lager	Takım Ölçüleri (mm) Dimension (mm) Abmessung (mm)						Kesici Uç Insert Wendeschneidplatte	Yedek Parçaları / Spare Parts / Ersatzteile		
		DC	ZEFP	DCON	LF	LH	APMX		Sıkma Vidası Screw Schraube	Tork Anahtar Torx Key Torx-Schlüssel	
ATM-C14-D14-W20-L100-Z01-H	●	14	1	20	100	25	14		3008-M2.5x6	80-T08	
ATM-C21-D18-W20-L100-Z01-H	●	18	1	20	100	30	21		4015-M4x9		
ATM-C21-D21-W25-L125-Z01-H	●	21	1	25	125	40	21		4015-M4x11	80-T15	
ATM-C21-D25-W20-L125-Z01-H	●	25	1	20	125	30	21				
ATM-C21-D28-W25-L90-Z01-H	●	28	1	25	90	30	21				
ATM-C21-D38-W32-L90-Z03-H	●	38	3	32	90	30	21				
ATM-C21-D38-W32-L120-Z03-H	●	38	3	32	120	30	21				
ATM-C21-D43-W32-L90-Z03-H	●	43	3	32	90	30	21	1020-M5x14	80-T20		
ATM-C30-D29-W25-L150-Z01-H	●	29	1	25	150	50	30				

CPT Ucuna Uygunur. / Compatible with CPT Insert. Kompatibel mit CPT Wendepplatten.

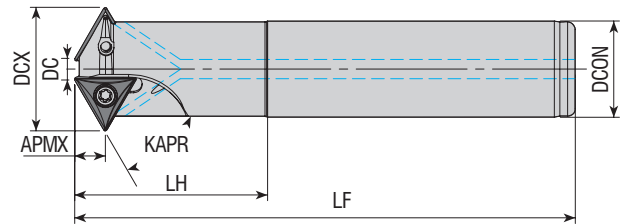

Takım Kodu Ordering Code Bestell-Bezeichnung	Stok Stock Lager	Takım Ölçüleri (mm) Dimension (mm) Abmessung (mm)								Kesici Uç Insert Wendeschneidplatte	Yedek Parçaları / Spare Parts / Ersatzteile		
		KAPR	DCX	DCON	DC	LF	LH	ZEFP	APMX		Sıkma Vidası Screw Schraube	Tork Anahtar Torx Key Torx-Schlüssel	
ATM60-TB0601-D13-C10-L150-Z02-H	●	60	13	10	2.5	150	40	2	3.3		3006-M2x4	80-T06	
ATM60-TC0902-D20.5-C16-L150-Z02-H	●	60	20.5	16	5.2	150	40	2	4.7		3007-M2.2x5	80-T07	
ATM60-TC1102-D26-C20-L150-Z03-H	●	60	26	20	8.3	150	50	3	5.4		3008-M2.5x6	80-T08	
ATM60-TC16T3-D32-C25-L150-Z02-H	●	60	32	25	6.4	150	50	2	8		4015-M3.5x9	80-T15	
ATM60-TC16T3-D40-C32-L250-Z03-H	●	60	40	32	13.7	250	50	3	8				

R: Sağ / Right / Rechts L: Sol/Left/Links

● Stokta / In Stock / Auf Lager ○ Stokta Yok / Non Stock Item / Kein Lagerartikel, Lieferzeit auf Anfrage  
ISO Ucuna Uygunur. / Compatible with ISO Insert. Kompatibel mit ISO Wendepplatten.

Sipariş Örneği/Ordering Example/Bestellbeispiel  
1 ad./pcs./stück ATM-C14-D14-W20-L100-Z01-H  
Kesme Hesabı : S 367 / Cutting Calculation : P 367 / Schnittberechnung : 367

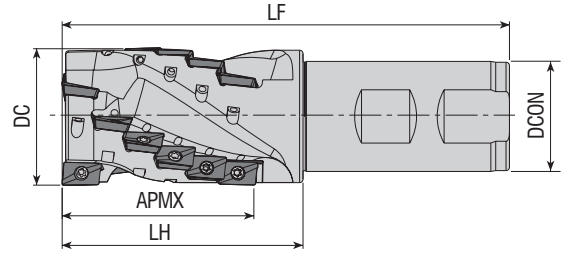
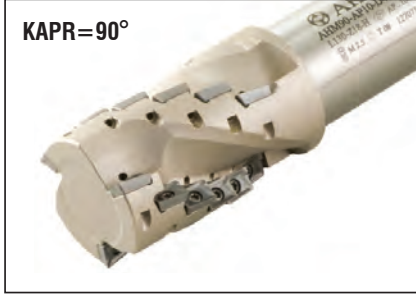

Takım Kodu Ordering Code Bestell-Bezeichnung	Stok Stock Lager	Takım Ölçüleri (mm) Dimension (mm) Abmessung (mm)							Kesici Uç Insert Wendeschneidplatte	Yedek Parçaları / Spare Parts / Ersatzteile	
		ZEFP		DC	DCON	APMX	LH	LF		Sıkma Vidası Screw Schraube	Tork Anahtar Torx Key Torx-Schlüssel
		Toplam Total Gesamt	Etkili Effective Effektiv								
AHM90-AP10-D20-W20-L087-Z0204	●	4	2	20	20	28	37	87	AP. 1003..	3008-M2.5x6	80-T08
AHM90-AP10-D20-W20-L087-Z0206	●	6	2	20	20	28	37	87			
AHM90-AP10-D25-W25-L105-Z0208-H	●	8	2	25	25	37	50	105			
AHM90-AP10-D32-W32-L115-Z0315-H	●	15	3	32	32	46	55	115			
AHM90-AP10-D40-W32-L130-Z0318-H	●	18	3	40	32	55	70	130			

ISO Ucuna Uygun. / Compatible with ISO Insert. Kompatibel mit ISO Wendepplatten.

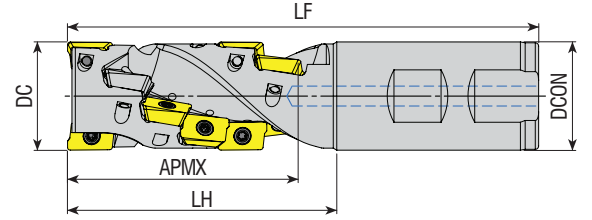

Takım Kodu Ordering Code Bestell-Bezeichnung	Stok Stock Lager	Takım Ölçüleri (mm) Dimension (mm) Abmessung (mm)							Kesici Uç Insert Wendeschneidplatte	Yedek Parçaları / Spare Parts / Ersatzteile	
		ZEFP		DC	DCON	APMX	LH	LF		Sıkma Vidası Screw Schraube	Tork Anahtar Torx Key Torx-Schlüssel
		Toplam Total Gesamt	Etkili Effective Effektiv								
AHM90-AP1204-D32-W32-L140-Z0212-H	●	12	2	32	32	68	80	140	AP. 1204..	3010-M3.5x9	80-T10
AHM90-AP1204-D40-W32-L160-Z0321-H	●	21	3	40	32	79	100	160			

R: Sağ / Right / Rechts L: Sol/Left/Links

● Stokta / In Stock / Auf Lager ○ Stokta Yok / Non Stock Item / Kein Lagerartikel, Lieferzeit auf Anfrage  
TGTC Ucuna Uygun. / Compatible with TGTC Insert. Kompatibel mit TGTC Wendepplatten.

Sipariş Örneği/Ordering Example/Bestellbeispiel

1 ad./pcs./stück AHM90-AP10-D20-W20-L087-Z0204

Kesme Hesabı : S 367 / Cutting Calculation : P 367 / Schnittberechnung : 367

**konusulan**  
**the spoken kalite...**  
**quality...**



KAPR=42°

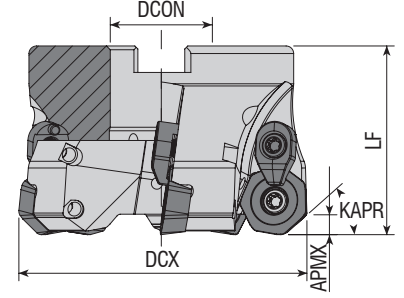

Takım Kodu Ordering Code Bestell-Bezeichnung	Stok Stock Lager	Takım Ölçüleri (mm) Dimension (mm) Abmessung (mm)					Kesici Uç Insert Wendeschneidplatte	Yedek Parçaları / Spare Parts / Ersatzteile					
		DCX	ZEFP	DCON	LF	APMX		Sıkma Vidası Screw Schraube	Baskı Parçası Wedge Clamp Spannpratze	Baskı Vidası Clamp Screw Klemmschraube	Tork Anahtar Torx Key Torx-Schlüssel	Montaj Vidası Mounting Screw Befestigungsschraube	
AFM42C-XD0806-D063-A27-Z04-H	●	63	4	27	50	12	XDMW 0806..	4020-M4.5x12	ACK-24	4020-M4.5x12	80-T20	2510-M12x35	
AFM42C-XD0806-D080-A27-Z05-H	●	80	5	27	50	12							
AFM42C-XD0806-D100-A32-Z06-H	●	100	6	32	63	12							2514-M16x35
AFM42C-XD0806-D125-B40-Z07	●	125	7	40	63	12							-
AFM42C-XD0806-D160-C40-Z08	●	160	8	40	63	12							-
AFM42C-XD0806-D200-C60-Z09	●	200	9	60	63	12							-

DJT Ucuna Uygun. / Compatible with DJT Insert. Kompatibel mit DJT Wendeplatten.

KAPR=43°

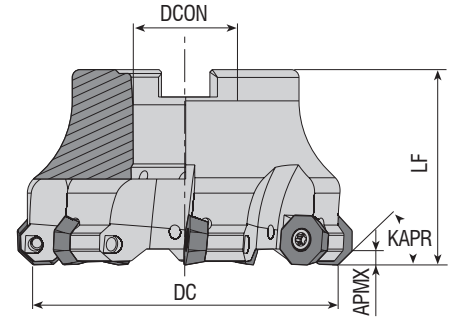

Takım Kodu Ordering Code Bestell-Bezeichnung	Stok Stock Lager	Takım Ölçüleri (mm) Dimension (mm) Abmessung (mm)					Kesici Uç Insert Wendeschneidplatte	Yedek Parçaları / Spare Parts / Ersatzteile			
		DC	ZEFP	DCON	LF	APMX		Sıkma Vidası Screw Schraube	Tork Anahtar Torx Key Torx-Schlüssel	Montaj Vidası Mounting Screw Befestigungsschraube	
AFM43-OD0504-D040-A16-Z04-H	●	40	4	16	40	3.5	OD.. 0504..	4015-M3.5x11	80-T15	2506-M8x30	
AFM43-OD0504-D050-A22-Z05-H	●	50	5	22	40	3.5					2407-M10x30
AFM43-OD0504-D063-A22-Z06-H	●	63	6	22	40	3.5					2510-M12x35
AFM43-OD0504-D080-A27-Z07-H	●	80	7	27	50	3.5					2514-M16x35
AFM43-OD0504-D100-A32-Z08-H	●	100	8	32	50	3.5					-

R: Sağ / Right / Rechts L: Sol/Left/Links

● Stokta / In Stock / Auf Lager ○ Stokta Yok / Non Stock Item / Kein Lagerartikel, Lieferzeit auf Anfrage  
WLTR Ucuna Uygun. / Compatible with WLTR Insert. Kompatibel mit WLTR Wendeplatten.

Sipariş Örneği/Ordering Example/Bestellbeispiel

1 ad./pcs./stück AFM42C-XD0806-D063-A27-Z04-H

Kesme Hesabı : S 367 / Cutting Calculation : P 367 / Schnittberechnung : 367  
Montaj Ölçüleri : S 364 / Mounting Reference : P 364 / Montagehinweis : 364



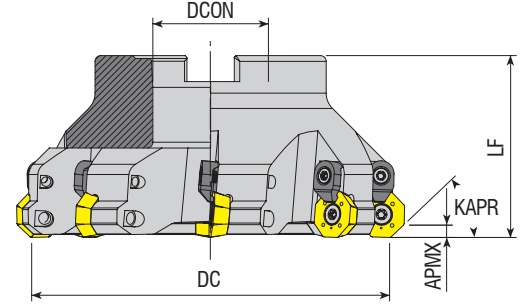

Takım Kodu Ordering Code Bestell-Bezeichnung	Stok Stock Lager	Takım Ölçüleri (mm) Dimension (mm) Abmessung (mm)					Kesici Uç Insert Wendeschneidplatte	Yedek Parçaları / Spare Parts / Ersatzteile					
		DC	ZEFP	DCON	LF	APMX		Sıkma Vidası Screw Schraube	Baskı Parçası Wedge Clamp Spannpratze	Baskı Vidası Clamp Screw Klemmschraube	Tork Anahtar Torx Key Torx-Schlüssel	Montaj Vidası Mounting Screw Befestigungsschraube	
AFM43C-OD0605-D080-A27-Z06-H	●	80	6	27	50	4	OD.. 0605..		ACK-05	4015-M4x11	80-T20	2510-M12x35	
AFM43C-OD0605-D100-A32-Z07-H	●	100	7	32	50	4						1020-M5x11	2514-M16x35
AFM43C-OD0605-D125-B40-Z08	●	125	8	40	63	4						-	

WLTR-LMN Ucuna Uygun. / Compatible with WLTR-LMN Insert. Kompatibel mit WLTR-LMN Wendepalten.

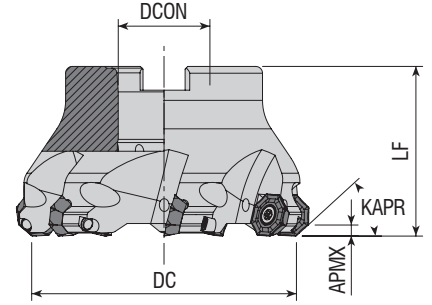

Takım Kodu Ordering Code Bestell-Bezeichnung	Stok Stock Lager	Takım Ölçüleri (mm) Dimension (mm) Abmessung (mm)					Kesici Uç Insert Wendeschneidplatte	Yedek Parçaları / Spare Parts / Ersatzteile			
		DC	ZEFP	DCON	LF	APMX		Sıkma Vidası Screw Schraube	Tork Anahtar Torx Key Torx-Schlüssel	Montaj Vidası Mounting Screw Befestigungsschraube	
AFM43-OF05T3-D050-A22-Z05-H	●	50	5	22	40	3	OF. 05T3..		80-T15	2407-M10x30	
AFM43-OF05T3-D063-A22-Z06-H	●	63	6	22	40	3				4015-M4x9	2510-M12x35
AFM43-OF05T3-D080-A27-Z07-H	●	80	7	27	50	3				4015-M4x11	-
AFM43-OF05T3-D125-B40-Z09	●	125	9	40	63	3				-	

R: Sağ / Right / Rechts L: Sol/Left/Links

● Stokta / In Stock / Auf Lager ○ Stokta Yok / Non Stock Item / Kein Lagerartikel, Lieferzeit auf Anfrage  
ISO Ucuna Uygun. / Compatible with ISO Insert. Kompatibel mit ISO Wendepalten.

Sipariş Örneği/Ordering Example/Bestellbeispiel

1 ad./pcs./stück AFM43C-OD0605-D080-A27-Z06-H

Kesme Hesabı : S 367 / Cutting Calculation : P 367 / Schnittberechnung : 367

Montaj Ölçüleri : S 364 / Mounting Reference : P 364 / Montagehinweis : 364

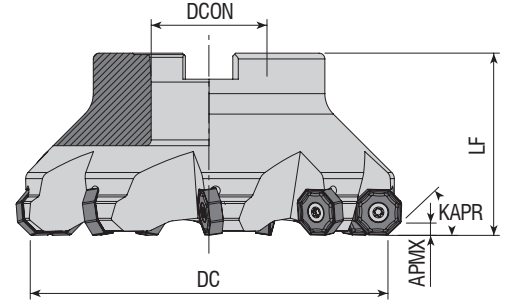

Takım Kodu Ordering Code Bestell-Bezeichnung	Stok Stock Lager	Takım Ölçüleri (mm) Dimension (mm) Abmessung (mm)					Kesici Uç Insert Wendeschneidplatte	Yedek Parçaları / Spare Parts / Ersatzteile		
		DC	ZAFP	DCON	LF	APMX		Sıkma Vidası Screw Schraube	Tork Anahtar Torx Key Torx-Schlüssel	Montaj Vidası Mounting Screw Befestigungsschraube
AFM43-ON0604-D050-A22-Z05-H	●	50	5	22	40	4	ON.. 0604..	4015-M4x11	80-T15	2407-M10x30
AFM43-ON0604-D063-A22-Z06-H	●	63	6	22	40	4				
AFM43-ON0604-D080-A27-Z07-H	●	80	7	27	50	4				
AFM43-ON0604-D100-A32-Z08-H	●	100	8	32	50	4				
AFM43-ON0604-D125-B40-Z09	●	125	9	40	63	4				

ZCC Ucuna Uygundur. / Compatible with ZCC Insert. Kompatibel mit ZCC Wendepfatten.

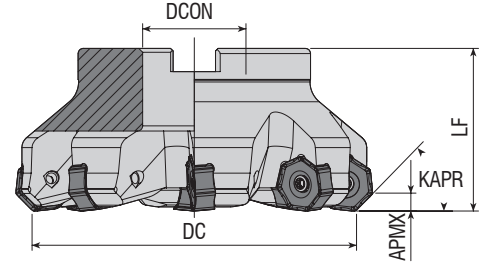

Takım Kodu Ordering Code Bestell-Bezeichnung	Stok Stock Lager	Takım Ölçüleri (mm) Dimension (mm) Abmessung (mm)					Kesici Uç Insert Wendeschneidplatte	Yedek Parçaları / Spare Parts / Ersatzteile		
		DC	ZAFP	DCON	LF	APMX		Sıkma Vidası Screw Schraube	Tork Anahtar Torx Key Torx-Schlüssel	Montaj Vidası Mounting Screw Befestigungsschraube
AFM44-ON0606-D063-A22-Z06-H	●	63	6	22	40	3.8	ONHX 0606..	4020-M4.5x12	80-T20	2407-M10x30
AFM44-ON0606-D080-A27-Z08-H	●	80	8	27	50	3.8				
AFM44-ON0606-D100-A32-Z10-H	●	100	10	32	50	3.8				

R: Sağ / Right / Rechts L: Sol/Left/Links

● Stokta / In Stock / Auf Lager ○ Stokta Yok / Non Stock Item / Kein Lagerartikel, Lieferzeit auf Anfrage  
KRLY Ucuna Uygundur. / Compatible with KRLY Insert. Kompatibel mit KRLY Wendepfatten.

Sipariş Örneği/Ordering Example/Bestellbeispiel

1 ad./pcs./stück AFM43-ON0604-D050-A22-Z05-H

Kesme Hesabı : S 367 / Cutting Calculation : P 367 / Schnittberechnung : 367

Montaj Ölçüleri : S 364 / Mounting Reference : P 364 / Montagehinweis : 364

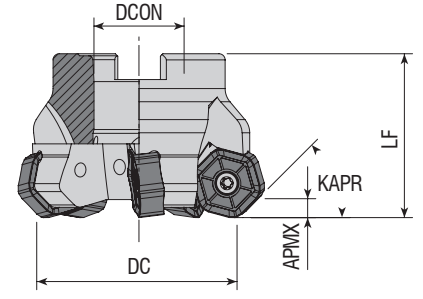

Takım Kodu Ordering Code Bestell-Bezeichnung	Stok Stock Lager	Takım Ölçüleri (mm) Dimension (mm) Abmessung (mm)					Kesici Uç Insert Wendeschneidplatte	Yedek Parçaları / Spare Parts / Ersatzteile			
		DC	ZEFP	DCON	LF	APMX		Sıkma Vidası Screw Schraube	Tork Anahtar Torx Key Torx-Schlüssel	Montaj Vidası Mounting Screw Befestigungsschraube	
AFM45-HN0905-D050-A22-Z05-H	●	50	5	22	40	4.5	HN.. 0905..	4015-M4x11	80-T15	-	2407-M10x30
AFM45-HN0905-D063-A22-Z06-H	●	63	6	22	40	4.5					2510-M12x35
AFM45-HN0905-D080-A27-Z07-H	●	80	7	27	50	4.5					2514-M16x35
AFM45L-HN0905-D100-A32-Z08-H	●	100	8	32	50	4.5					
AFM45-HN0905-D125-B40-Z10	●	125	10	40	63	4.5					
AFM45L-HN0905-D125-B40-Z10	●	125	10	40	63	4.5					
AFM45-HN0905-D160-C40-Z12	●	160	12	40	63	4.5					
AFM45L-HN0905-D160-C40-Z12	●	160	12	40	63	4.5					
AFM45-HN0905-D200-C60-Z16	●	200	16	60	63	4.5					
AFM45L-HN0905-D200-C60-Z16	●	200	16	60	63	4.5					

WDA Ucuna Uygun. / Compatible with WDA Insert. Kompatibel mit WDA Wendepalten.

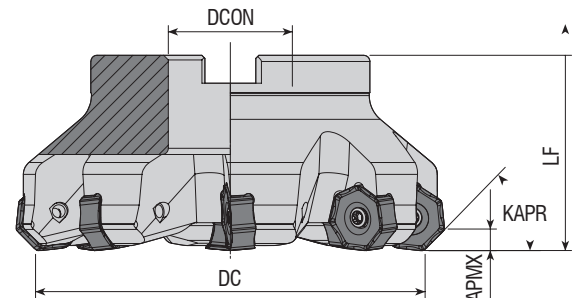

Takım Kodu Ordering Code Bestell-Bezeichnung	Stok Stock Lager	Takım Ölçüleri (mm) Dimension (mm) Abmessung (mm)					Kesici Uç Insert Wendeschneidplatte	Yedek Parçaları / Spare Parts / Ersatzteile			
		DC	ZEFP	DCON	LF	APMX		Sıkma Vidası Screw Schraube	Tork Anahtar Torx Key Torx-Schlüssel	Montaj Vidası Mounting Screw Befestigungsschraube	
AFM45-NN2007-D100-A32-Z07-H	●	100	7	32	50	6	NNMU 2007..	1020-M5x14	80-T20	2514-M16x35	
AFM45-NN2007-D125-B40-Z08	●	125	8	40	63	6					
AFM45-NN2007-D160-C40-Z10	●	160	10	40	63	6					

R: Sağ / Right / Rechts L: Sol/Left/Links  
● Stokta / In Stock / Auf Lager ○ Stokta Yok / Non Stock Item / Kein Lagerartikel, Lieferzeit auf Anfrage  
MTSBSH Ucuna Uygun. / Compatible with MTSBSH Insert. Kompatibel mit MTSBSH Wendepalten.

Sipariş Örneği/Ordering Example/Bestellbeispiel  
1 ad./pcs./stück AFM45-HN0905-D063-A22-Z06-H  
Kesme Hesabı : S 367 / Cutting Calculation : P 367 / Schnittberechnung : 367  
Montaj Ölçüleri : S 364 / Mounting Reference : P 364 / Montagehinweis : 364

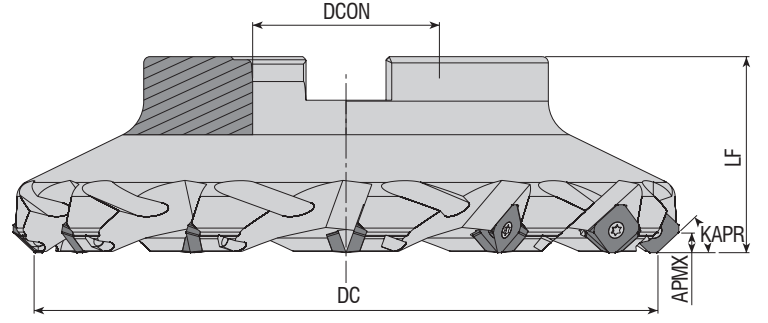

Takım Kodu Ordering Code Bestell-Bezeichnung	Stok Stock Lager	Takım Ölçüleri (mm) Dimension (mm) Abmessung (mm)					Kesici Uç Insert Wendeschneidplatte	Yedek Parçaları / Spare Parts / Ersatzteile			
		DC	ZEFP	DCON	LF	APMX		Sıkma Vidası Screw Schraube	Tork Anahtar Torx Key Torx-Schlüssel	Montaj Vidası Mounting Screw Befestigungsschraube	
AFM45-SE12-D050-A22-Z04-H	●	50	4	22	40	6	SE.. 12T3.. R245-12T3..	4015-M3.5x11	80-T15	2407-M10x30	
AFM45L-SE12-D050-A22-Z04-H	●	50	4	22	40	6					
AFM45-SE12-D063-A22-Z05-H	●	63	5	22	40	6					
AFM45L-SE12-D063-A22-Z05-H	●	63	5	22	40	6					
AFM45-SE12-D080-A27-Z06-H	●	80	6	27	50	6					
AFM45L-SE12-D080-A27-Z06-H	●	80	6	27	50	6					
AFM45-SE12-D100-A32-Z07-H	●	100	7	32	50	6					
AFM45-SE12-D125-B40-Z08	●	125	8	40	63	6					
AFM45-SE12-D160-C40-Z10	●	160	10	40	63	6					
AFM45L-SE12-D160-C40-Z10	●	160	10	40	63	6					
AFM45-SE12-D200-C60-Z12	●	200	12	60	63	6					

ZCC-SNDVK Ucuna Uygundur. / Compatible with ZCC-SNDVK Insert. Kompatibel mit ZCC-SNDVK Wendepfatten.

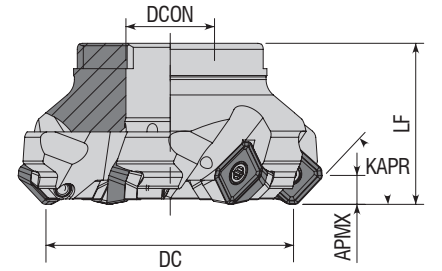

Takım Kodu Ordering Code Bestell-Bezeichnung	Stok Stock Lager	Takım Ölçüleri (mm) Dimension (mm) Abmessung (mm)					Kesici Uç Insert Wendeschneidplatte	Yedek Parçaları / Spare Parts / Ersatzteile				
		DC	ZEFP	DCON	LF	APMX		Altık Screw Unterlage	Altık Vidası Wedge Clamp Schraube für Unterlage	Sıkma Vidası Screw Schraube	Tork Anahtar Torx Key Torx-Schlüssel	Montaj Vidası Mounting Screw Befestigungsschraube
AFM45-SE13-D050-A22-Z04-H	●	50	4	22	40	6	SEMT 13T3..	AASE-3-0001	AAV-16-M3.5x8	4015-M3.5x12	80-T15	2407-M10x30
AFM45-SE13-D063-A22-Z05-H	●	63	5	22	40	6						
AFM45-SE13-D080-A27-Z06-H	●	80	6	27	50	6						
AFM45S-SE13-D050-A22-Z05-H	●	50	5	22	40	6						
AFM45S-SE13-D063-A22-Z06-H	●	63	6	22	40	6						
AFM45S-SE13-D080-A27-Z08-H	●	80	8	27	50	6						
AFM45S-SE13-D100-A32-Z10-H	●	100	10	32	50	6						
AFM45S-SE13-D125-B40-Z12	●	125	12	40	63	6						

R: Sağ / Right / Rechts L: Sol/Left/Links

● Stokta / In Stock / Auf Lager ○ Stokta Yok / Non Stock Item / Kein Lagerartikel, Lieferzeit auf Anfrage  
SMTM-DJT Ucuna Uygundur. / Compatible with SMTM-DJT Insert. Kompatibel mit SMTM-DJT Wendepfatten.

Sipariş Örneği/Ordering Example/Bestellbeispiel

1 ad./pcs./stück AFM45-SE12-D050-A22-Z04-H

Kesme Hesabı : S 367 / Cutting Calculation : P 367 / Schnittberechnung : 367  
Montaj Ölçüleri : S 364 / Mounting Reference : P 364 / Montagehinweis : 364



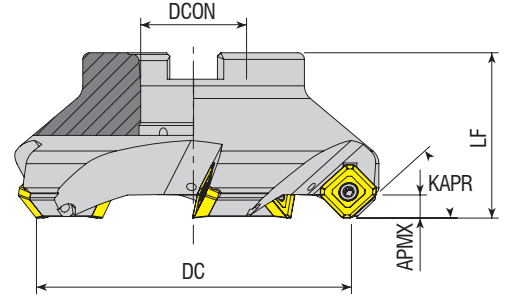

Takım Kodu Ordering Code Bestell-Bezeichnung	Stok Stock Lager	Takım Ölçüleri (mm) Dimension (mm) Abmessung (mm)					Kesici Uç Insert Wendeschneidplatte	Yedek Parçaları / Spare Parts / Ersatzteile			
		DC	ZEFP	DCON	LF	APMX		Sıkma Vidası Screw Schraube	Tork Anahtar Torx Key Torx-Schlüssel	Montaj Vidası Mounting Screw Befestigungsschraube	
AFM45-SE14M4-D063-A22-Z04-H	●	63	4	22	40	7	SE.. 14M4..	4015-M3.5x11	80-T15	2407-M10x30 2510-M12x35 2514-M16x35	
AFM45-SE14M4-D080-A27-Z05-H	●	80	5	27	50	7					
AFM45-SE14M4-D100-A32-Z05-H	●	100	5	32	50	7					
AFM45-SE14M4-D125-B40-Z06	●	125	6	40	63	7					
AFM45-SE14M4-D160-C40-Z07	●	160	7	40	63	7					

KRLY Ucuna Uygun. / Compatible with KRLY Insert. Kompatibel mit KRLY Wendeschneidplatten.

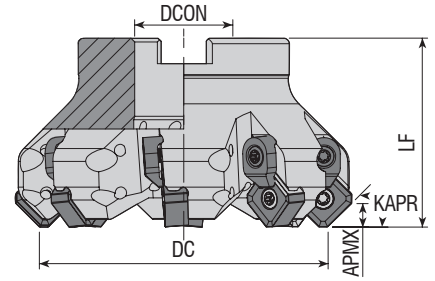

Takım Kodu Ordering Code Bestell-Bezeichnung	Stok Stock Lager	Takım Ölçüleri (mm) Dimension (mm) Abmessung (mm)					Kesici Uç Insert Wendeschneidplatte	Yedek Parçaları / Spare Parts / Ersatzteile				
		DC	ZEFP	DCON	LF	APMX		Sıkma Vidası Screw Schraube	Baskı Parçası Wedge Clamp Spannpratze	Baskı Vidası Clamp Screw Klemmschraube	Tork Anahtar Torx Key Torx-Schlüssel	Montaj Vidası Mounting Screw Befestigungsschraube
AFM45C-SN12..-D050-A22-Z04-H	●	50	4	22	42	6	SN.. 12..	1015-M4x11	ACK-05	4015-M4x11	80-T15	2407-M10x30 2510-M12x35 2514-M16x35
AFM45C-SN12..-D050-A22-Z05-H	●	50	5	22	42	6						
AFM45C-SN12..-D063-A22-Z06-H	●	63	6	22	42	6						
AFM45C-SN12..-D063-A22-Z07-H	●	63	7	22	42	6						
AFM45CL-SN12..-D063-A22-Z07-H	●	63	7	22	42	6						
AFM45C-SN12..-D080-A27-Z07-H	●	80	7	27	52	6						
AFM45C-SN12..-D080-A27-Z08-H	●	80	8	27	52	6						
AFM45CL-SN12..-D080-A27-Z08-H	●	80	8	27	52	6						
AFM45C-SN12..-D100-A32-Z08-H	●	100	8	32	52	6						
AFM45C-SN12..-D100-A32-Z10-H	●	100	10	32	52	6						
AFM45CL-SN12..-D100-A32-Z10-H	●	100	10	32	52	6						
AFM45C-SN12..-D125-B40-Z11	●	125	11	40	65	6						
AFM45CL-SN12..-D125-B40-Z11	●	125	11	40	65	6						
AFM45C-SN12..-D160-C40-Z12	●	160	12	40	65	6						
AFM45C-SN12..-D200-C60-Z14	●	200	14	60	65	6						
AFM45CL-SN12..-D200-C60-Z14	●	200	14	60	65	6						

R: Sağ / Right / Rechts L: Sol/Left/Links

● Stokta / In Stock / Auf Lager ○ Stokta Yok / Non Stock Item / Kein Lagerartikel, Lieferzeit auf Anfrage

WLTR-LMN-ACHTK Ucuna Uygun. / Compatible with WLTR-LMN-ACHTK Insert. Kompatibel mit WLTR-LMN-ACHTK Wendeschneidplatten.

Montaj Ölçüleri : S 364 / Mounting Reference : P 364 / Montagehinweis : 364

Sipariş Örneği/Ordering Example/Bestellbeispiel

1 ad./pcs./stück AFM45-SE14M4-D063-A22-Z04-H

Kesme Hesabı : S 367 / Cutting Calculation : P 367 / Schnittberechnung : 367

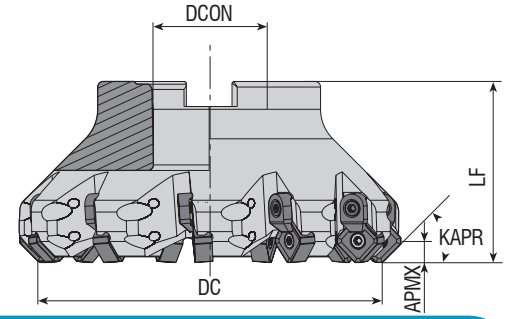

Takım Kodu Ordering Code Bestell-Bezeichnung	Stok Stock Lager	Takım Ölçüleri (mm) Dimension (mm) Abmessung (mm)					Kesici Uç Insert Wendeschneidplatte	Yedek Parçaları / Spare Parts / Ersatzteile				
		DC	ZEFP	DCON	LF	APMX		Sıkma Vidası Screw Schraube	Baskı Parçası Wedge Clamp Spannpratze	Baskı Vidası Clamp Screw Klemmschraube	Tork Anahtar Torx Key Torx-Schlüssel	Montaj Vidası Mounting Screw Befestigungsschraube
AFM45C-SN1206-D050-A22-Z04-H	●	50	4	22	42	6	SN.. 1206..	4015-M4x11	ACK-05	4015-M4x11	80-T15	2407-M10x30
AFM45CL-SN1206-D050-A22-Z05-H	●	50	5	22	42	6						
AFM45C-SN1206-D050-A22-Z05-H	●	50	5	22	42	6						
AFM45C-SN1206-D063-A22-Z06-H	●	63	6	22	42	6						
AFM45C-SN1206-D063-A22-Z07-H	●	63	7	22	42	6						
AFM45CL-SN1206-D063-A22-Z07-H	●	63	7	22	42	6						
AFM45C-SN1206-D080-A27-Z07-H	●	80	7	27	52	6						
AFM45C-SN1206-D080-A27-Z08-H	●	80	8	27	52	6						
AFM45CL-SN1206-D080-A27-Z08-H	●	80	8	27	52	6						
AFM45C-SN1206-D100-A32-Z08-H	●	100	8	32	52	6						
AFM45C-SN1206-D100-A32-Z10-H	●	100	10	32	52	6						
AFM45CL-SN1206-D100-A32-Z10-H	●	100	10	32	52	6						
AFM45C-SN1206-D125-B40-Z11	●	125	11	40	65	6						
AFM45CL-SN1206-D125-B40-Z11	●	125	11	40	65	6						
AFM45C-SN1206-D160-C40-Z12	●	160	12	40	65	6						
AFM45C-SN1206-D200-C60-Z14	●	200	14	60	65	6						
AFM45CL-SN1206-D200-C60-Z14	●	200	14	60	65	6						

KRLY-PLBT-BHLR Ucuna Uygunur. / Compatible with KRLY-PLBT-BHLR Insert. Kompatibel mit KRLY-PLBT-BHLR Wendeschneidplatten.

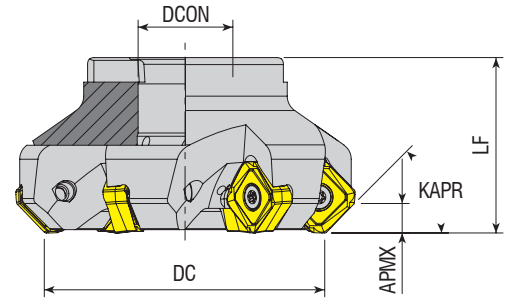

Takım Kodu Ordering Code Bestell-Bezeichnung	Stok Stock Lager	Takım Ölçüleri (mm) Dimension (mm) Abmessung (mm)					Kesici Uç Insert Wendeschneidplatte	Yedek Parçaları / Spare Parts / Ersatzteile		
		DC	ZEFP	DCON	LF	APMX		Sıkma Vidası Screw Schraube	Tork Anahtar Torx Key Torx-Schlüssel	Montaj Vidası Mounting Screw Befestigungsschraube
AFM45-SA1706-D080-A27-Z06-H	●	80	6	27	50	8.4	SAKU 1706..	1020-M5x14	80-T20	2510-M12x35
AFM45-SA1706-D100-A32-Z07-H	●	100	7	32	50	8.4				2514-M16x35
AFM45-SA1706-D125-B40-Z09	●	125	9	40	63	8.4				-

R: Sağ / Right / Rechts L: Sol/Left/Links

● Stokta / In Stock / Auf Lager ○ Stokta Yok / Non Stock Item / Kein Lagerartikel, Lieferzeit auf Anfrage

CRTZT Ucuna Uygunur. / Compatible with CRTZT Insert. Kompatibel mit CRTZT Wendeschneidplatten.

Sipariş Örneği/Ordering Example/Bestellbeispiel

1 ad./pcs./stück AFM45C-SN1206-D050-A22-Z04-H

Kesme Hesabı : S 367 / Cutting Calculation : P 367 / Schnittberechnung : 367

Montaj Ölçüleri : S 364 / Mounting Reference : P 364 / Montagehinweis : 364

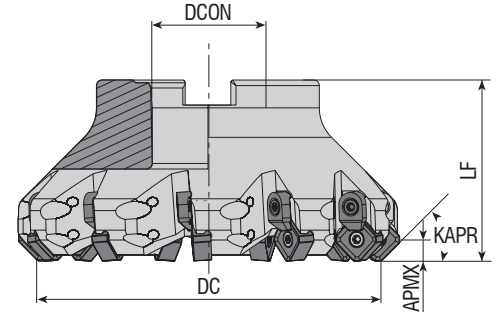

Takım Kodu Ordering Code Bestell-Bezeichnung	Stok Stock Lager	Takım Ölçüleri (mm) Dimension (mm) Abmessung (mm)					Kesici Uç Insert Wendeschneidplatte	Yedek Parçaları / Spare Parts / Ersatzteile					
		DC	ZEFP	DCON	LF	APMX		Sıkma Vidası Screw Schraube	Baskı Parçası Wedge Clamp Spannpratze	Baskı Vidası Clamp Screw Klemmschraube	Tork Anahtar Torx Key Torx-Schlüssel	Montaj Vidası Mounting Screw Befestigungsschraube	
AFM45C-SN12Z-D050-A22-Z05-H	●	50	5	22	42	6	SNEG 1205..						
AFM45C-SN12Z-D063-A22-Z06-H	●	63	6	22	42	6							2407-M10X30
AFM45C-SN12Z-D080-A27-Z07-H	●	80	7	27	52	6							2510-M12x35
AFM45C-SN12Z-D100-A32-Z09-H	●	100	9	32	52	6							2514-M16x35
AFM45C-SN12Z-D125-B40-Z11	●	125	11	40	65	6							-
AFM45C-SN12Z-D160-C40-Z12	●	160	12	60	65	6							-
AFM45C-SN12Z-D200-C60-Z14	●	200	14	60	65	6							-

ZCC Ucuna Uygundur. / Compatible with ZCC Insert. Kompatibel mit ZCC Wendeplatten.

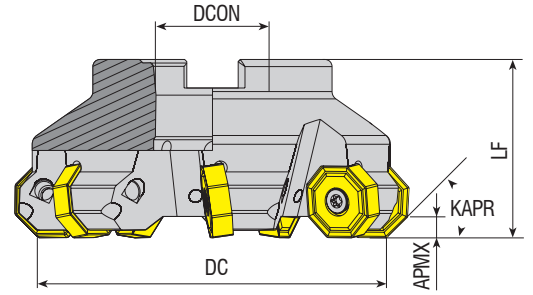

Takım Kodu Ordering Code Bestell-Bezeichnung	Stok Stock Lager	Takım Ölçüleri (mm) Dimension (mm) Abmessung (mm)					Kesici Uç Insert Wendeschneidplatte	Yedek Parçaları / Spare Parts / Ersatzteile			
		DC	ZEFP	DCON	LF	APMX		Sıkma Vidası Screw Schraube	Tork Anahtar Torx Key Torx-Schlüssel	Montaj Vidası Mounting Screw Befestigungsschraube	
AFM45-ON0806-D063-A22-Z05-H	●	63	5	22	40	5.5	ON.. 0806..				
AFM45-ON0806-D063-A22-Z06-H	●	63	6	22	40	5.5					2508-M10x30
AFM45-ON0806-D080-A27-Z06-H	●	80	6	27	50	5.5					2510-M12x35
AFM45-ON0806-D080-A27-Z08-H	●	80	8	27	50	5.5					2514-M16x35
AFM45-ON0806-D100-A32-Z07-H	●	100	7	32	50	5.5					-
AFM45-ON0806-D100-A32-Z10-H	●	100	10	32	50	5.5					-
AFM45-ON0806-D125-B40-Z08	●	125	8	40	63	5.5					-
AFM45-ON0806-D125-B40-Z12	●	125	12	40	63	5.5					-
AFM45-ON0806-D160-C40-Z10	●	160	10	40	63	5.5					-
AFM45-ON0806-D160-C40-Z14	●	160	14	40	63	5.5					-
AFM45-ON0806-D200-C60-Z12	●	200	12	60	63	5.5					-
AFM45-ON0806-D250-C60-Z14	●	250	14	60	63	5.5					-
AFM45-ON0806-D315-D60-Z16	●	315	16	60	63	5.5					-

R: Sağ / Right / Rechts L: Sol/Left/Links  
● Stokta / In Stock / Auf Lager ○ Stokta Yok / Non Stock Item / Kein Lagerartikel, Lieferzeit auf Anfrage  
ISO Ucuna Uygundur. / Compatible with ISO Insert. Kompatibel mit ISO Wendeplatten.

Sipariş Örneği/Ordering Example/Bestellbeispiel  
1 ad./pcs./stück AFM45C-SN12Z-D050-A22-Z05-H  
Kesme Hesabı : S 367 / Cutting Calculation : P 367 / Schnittberechnung : 367  
Montaj Ölçüleri : S 364 / Mounting Reference : P 364 / Montagehinweis : 364

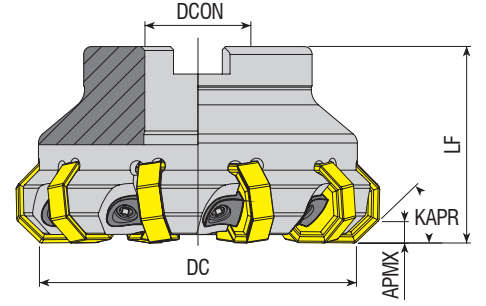

Takım Kodu Ordering Code Bestell-Bezeichnung	Stok Stock Lager	Takım Ölçüleri (mm) Dimension (mm) Abmessung (mm)					Kesici Uç Insert Wendeschneidplatte	Yedek Parçaları / Spare Parts / Ersatzteile				
		DC	ZEFP	DCON	LF	APMX		Baskı Parçası Wedge Clamp Spannpratze	Baskı Vidası Clamp Screw Klemmschraube	Anahtar Allen Key Innensechskantschlüssel	Montaj Vidası Mounting Screw Befestigungsschraube	
AFM45C-ON0806-D080-A27-Z10	●	80	10	27	50	5.5	ON.. 0806..	ACK-26	AKV-26-M6x0.75x20	AAL-03-3	2510-M12x35	
AFM45C-ON0806-D100-A32-Z14	●	100	14	32	50	5.5					2514-M16x35	
AFM45C-ON0806-D125-B40-Z18	●	125	18	40	63	5.5					-	
AFM45C-ON0806-D160-C40-Z22	●	160	22	40	63	5.5					-	

ISO Ucuna Uygun. / Compatible with ISO Insert. Kompatibel mit ISO Wendeplatten.

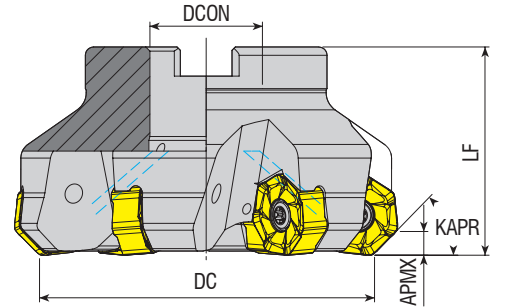

Takım Kodu Ordering Code Bestell-Bezeichnung	Stok Stock Lager	Takım Ölçüleri (mm) Dimension (mm) Abmessung (mm)					Kesici Uç Insert Wendeschneidplatte	Yedek Parçaları / Spare Parts / Ersatzteile				
		DC	ZEFP	DCON	LF	APMX		Sıkma Vidası Screw Schraube	Baskı Parçası Wedge Clamp Spannpratze	Baskı Vidası Clamp Screw Klemmschraube	Tork Anahtar Torx Key Torx-Schlüssel	Montaj Vidası Mounting Screw Befestigungsschraube
AFM45-XN0906-D063-A22-Z06-H	●	63	6	22	50	5	XNMU 0906..	1120-M5x13	-	-	80-T20	2407-M10x30
AFM45-XN0906-D080-A27-Z06-H	●	80	6	27	50	5						2510-M12x35
AFM45-XN0906-D100-A32-Z07-H	●	100	7	32	55	5						2514-M16x35
AFM45-XN0906-D125-B40-Z08	●	125	8	40	63	5						-

R: Sağ / Right / Rechts L: Sol/Left/Links  
● Stokta / In Stock / Auf Lager ○ Stokta Yok / Non Stock Item / Kein Lagerartikel, Lieferzeit auf Anfrage  
TGTC Ucuna Uygun. / Compatible with TGTC Insert. Kompatibel mit TGTC Wendeplatten.

Sipariş Örneği/Ordering Example/Bestellbeispiel  
1 ad./pcs./stück AFM45C-ON0806-D080-A27-Z10  
Kesme Hesabı : S 367 / Cutting Calculation : P 367 / Schnittberechnung : 367  
Montaj Ölçüleri : S 364 / Mounting Reference : P 364 / Montagehinweis : 364



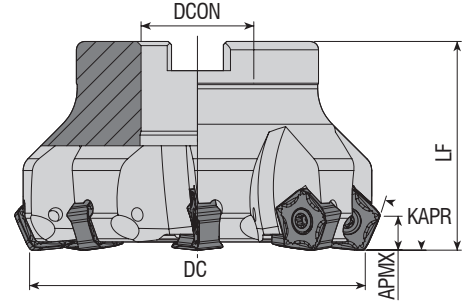

Takım Kodu Ordering Code Bestell-Bezeichnung	Stok Stock Lager	Takım Ölçüleri (mm) Dimension (mm) Abmessung (mm)					Kesici Uç Insert Wendeschneidplatte	Yedek Parçaları / Spare Parts / Ersatzteile				
		DC	ZEFP	DCON	LF	APMX		Sıkma Vidası Screw Schraube	Tork Anahtar Torx Key Torx-Schlüssel	Montaj Vidası Mounting Screw Befestigungsschraube		
AFM66-PN0905-D050-A22-Z05	●	50	5	22	40	8	PNMU 0905..		80-T15			
AFM66-PN0905-D063-A22-Z06	●	63	6	22	40	8						2508-M10x30
AFM66-PN0905-D080-A27-Z08	●	80	8	27	50	8						2510-M12x35
AFM66-PN0905-D100-A32-Z10	●	100	10	32	50	8						2514-M16x35
AFM66-PN0905-D125-B40-Z12	●	125	12	40	63	8						-

KYCR Ucuna Uygundur. / Compatible with KYCR Insert. Kompatibel mit KYCR Wendeplatten.

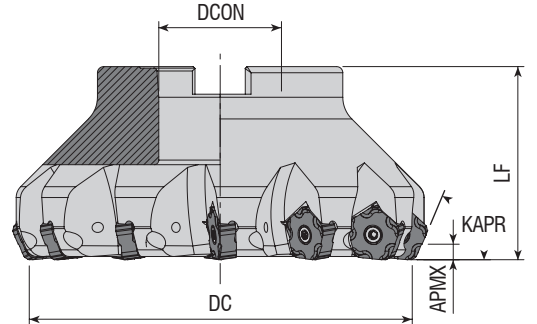

Takım Kodu Ordering Code Bestell-Bezeichnung	Stok Stock Lager	Takım Ölçüleri (mm) Dimension (mm) Abmessung (mm)					Kesici Uç Insert Wendeschneidplatte	Yedek Parçaları / Spare Parts / Ersatzteile				
		DC	ZEFP	DCON	LF	APMX		Sıkma Vidası Screw Schraube	Tork Anahtar Torx Key Torx-Schlüssel	Montaj Vidası Mounting Screw Befestigungsschraube		
AFM67-PN1105-D050-A22-Z05	●	50	5	22	50	5	PNEG 1105..		80-T15			
AFM67-PN1105-D063-A22-Z06	●	63	6	22	50	5						2508-M10x30
AFM67-PN1105-D080-A27-Z08	●	80	8	27	50	5						2510-M12x35
AFM67-PN1105-D100-B32-Z10	●	100	10	32	50	5						-
AFM67-PN1105-D125-B40-Z12	●	125	12	40	63	5						-
AFM67-PN1105-D160-C40-Z14	●	160	14	40	63	5						-

R: Sağ / Right / Rechts L: Sol/Left/Links  
● Stokta / In Stock / Auf Lager ○ Stokta Yok / Non Stock Item / Kein Lagerartikel, Lieferzeit auf Anfrage  
ZCC Ucuna Uygundur. / Compatible with ZCC Insert. Kompatibel mit ZCC Wendeplatten.

Sipariş Örneği/Ordering Example/Bestellbeispiel  
1 ad./pcs./stück AFM66-PN0905-D050-A22-Z05  
Kesme Hesabı : S 367 / Cutting Calculation : P 367 / Schnittberechnung : 367  
Montaj Ölçüleri : S 364 / Mounting Reference : P 364 / Montagehinweis : 364

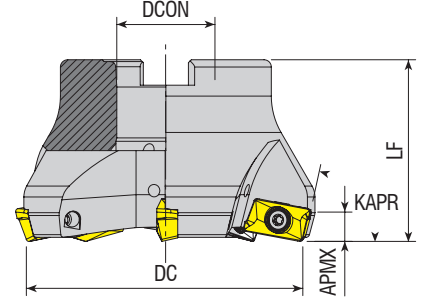

Takım Kodu Ordering Code Bestell-Bezeichnung	Stok Stock Lager	Takım Ölçüleri (mm) Dimension (mm) Abmessung (mm)					Kesici Uç Insert Wendeschneidplatte	Yedek Parçaları / Spare Parts / Ersatzteile		
		DC	ZEFP	DCON	LF	APMX		Sıkma Vidası Screw Schraube	Tork Anahtar Torx Key Torx-Schlüssel	Montaj Vidası Mounting Screw Befestigungsschraube
AFM75-AP16-D063-A22-Z04-H	●	63	4	22	40	6	AP. 1604..	4015-M4x11	80-T15	2508-M10x30
AFM75-AP16-D080-A27-Z05-H	●	80	5	27	50	6				2510-M12x35
AFM75-AP16-D100-A32-Z06-H	●	100	6	32	50	6				2514-M16x35
AFM75-AP16-D125-B40-Z07	●	125	7	40	63	6				-

ISO Ucuna Uygunur. / Compatible with ISO Insert. Kompatibel mit ISO Wendepplatten.

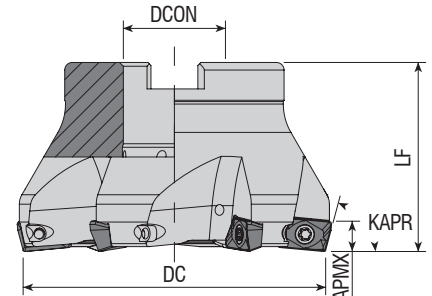

Takım Kodu Ordering Code Bestell-Bezeichnung	Stok Stock Lager	Takım Ölçüleri (mm) Dimension (mm) Abmessung (mm)					Kesici Uç Insert Wendeschneidplatte	Yedek Parçaları / Spare Parts / Ersatzteile		
		DC	ZEFP	DCON	LF	APMX		Sıkma Vidası Screw Schraube	Tork Anahtar Torx Key Torx-Schlüssel	Montaj Vidası Mounting Screw Befestigungsschraube
AFM75-X012-D050-A22-Z04-H	●	50	4	22	40	-	XOMX 1204..	3010-M3.5x9	80-T10	2508-M10x30
AFM75-X012-D063-A22-Z05-H	●	63	5	22	40	-				2510-M12x35
AFM75-X012-D080-A27-Z06-H	●	80	6	27	50	-				

R: Sağ / Right / Rechts L: Sol/Left/Links  
● Stokta / In Stock / Auf Lager ○ Stokta Yok / Non Stock Item / Kein Lagerartikel, Lieferzeit auf Anfrage  
SC Ucuna Uygunur. / Compatible with SC Insert. Kompatibel mit SC Wendepplatten.

Sipariş Örneği/Ordering Example/Bestellbeispiel  
1 ad./pcs./stück AFM75-AP16-D063-A22-Z04-H  
Kesme Hesabı : S 367 / Cutting Calculation : P 367 / Schnittberechnung : 367  
Montaj Ölçüleri : S 364 / Mounting Reference : P 364 / Montagehinweis : 364

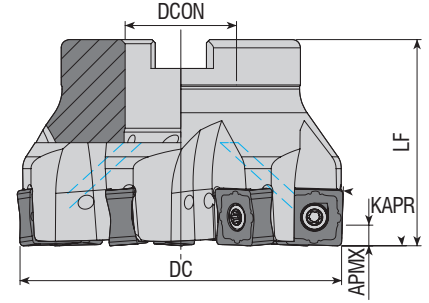

Takım Kodu Ordering Code Bestell-Bezeichnung	Stok Stock Lager	Takım Ölçüleri (mm) Dimension (mm) Abmessung (mm)					Kesici Uç Insert Wendeschneidplatte	Yedek Parçaları / Spare Parts / Ersatzteile			
		DC	ZEP	DCON	LF	APMX		Sıkma Vidası Screw Schraube	Tork Anahtar Torx Key Torx-Schlüssel	Montaj Vidası Mounting Screw Befestigungsschraube	
AFM88-SN1305-D050-A22-Z04	●	50	4	22	40	5	SNMU 1305..	4015-M4x11	80-T15	2508-M10x30	
AFM88-SN1305-D050-A22-Z05	●	50	5	22	40	5					
AFM88-SN1305-D063-A22-Z05	●	63	5	22	40	5					
AFM88-SN1305-D063-A22-Z07	●	63	7	22	40	5					
AFM88-SN1305-D080-A27-Z06	●	80	6	27	50	5					
AFM88-SN1305-D080-A27-Z09	●	80	9	27	50	5					
AFM88-SN1305-D100-A32-Z07	●	100	7	32	50	5					
AFM88-SN1305-D100-A32-Z11	●	100	11	32	50	5					
AFM88-SN1305-D125-B40-Z13	●	125	13	40	63	5					-

KYCR Ucuna Uygun. / Compatible with KYCR Insert. Kompatibel mit KYCR Wendepalten.

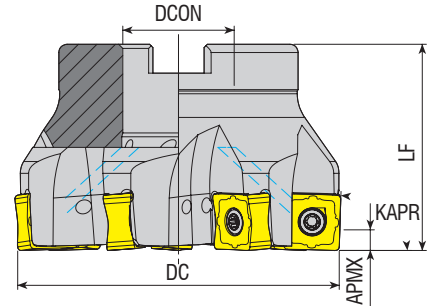

Takım Kodu Ordering Code Bestell-Bezeichnung	Stok Stock Lager	Takım Ölçüleri (mm) Dimension (mm) Abmessung (mm)					Kesici Uç Insert Wendeschneidplatte	Yedek Parçaları / Spare Parts / Ersatzteile			
		DC	ZEP	DCON	LF	APMX		Sıkma Vidası Screw Schraube	Tork Anahtar Torx Key Torx-Schlüssel	Montaj Vidası Mounting Screw Befestigungsschraube	
AFM88-SN1306-D050-A22-Z05-H	●	50	5	22	40	5	SNGX 1306..	1115-M4x10	80-T15	2508-M10x30	
AFM88-SN1306-D063-A22-Z06-H	●	63	6	22	40	5					
AFM88-SN1306-D080-A27-Z07-H	●	80	7	27	50	5					2510-M12x35

R: Sağ / Right / Rechts L: Sol/Left/Links  
● Stokta / In Stock / Auf Lager ○ Stokta Yok / Non Stock Item / Kein Lagerartikel, Lieferzeit auf Anfrage  
TGTC Ucuna Uygun. / Compatible with TGTC Insert. Kompatibel mit TGTC Wendepalten.

Sipariş Örneği/Ordering Example/Bestellbeispiel  
1 ad./pcs./stück AFM88-SN1305-D050-A22-Z04  
Kesme Hesabı : S 367 / Cutting Calculation : P 367 / Schnittberechnung : 367  
Montaj Ölçüleri : S 364 / Mounting Reference : P 364 / Montagehinweis : 364

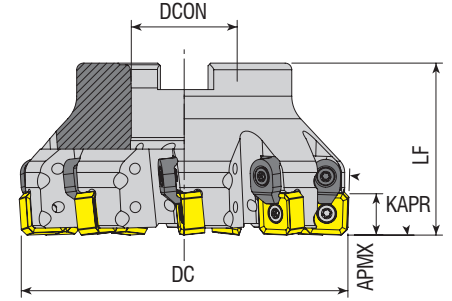

Takım Kodu Ordering Code Bestell-Bezeichnung	Stok Stock Lager	Takım Ölçüleri (mm) Dimension (mm) Abmessung (mm)					Kesici Uç Insert Wendeschneidplatte	Yedek Parçaları / Spare Parts / Ersatzteile				
		DC	ZEFP	DCON	LF	APMX		Sıkma Vidası Screw Schraube	Baskı Parçası Wedge Clamp Spannpratze	Baskı Vidası Clamp Screw Klemmschraube	Tork Anahtar Torx Key Torx-Schlüssel	Montaj Vidası Mounting Screw Befestigungsschraube
AFM88C-SN1206-D050-A22-Z05-H	●	50	5	22	40	11.5	SN.. 1206..	4615-M4x11	ACK-05	4015-M4x11	80-T15	2508-M10x30
AFM88C-SN1206-D063-A22-Z06-H	●	63	6	22	40	11.5						
AFM88C-SN1206-D080-A27-Z07-H	●	80	7	27	50	11.5						
AFM88C-SN1206-D100-A32-Z09-H	●	100	9	32	52	11.5						

ISO Ucuna Uygun. / Compatible with ISO Insert. Kompatibel mit ISO Wendepplatten.

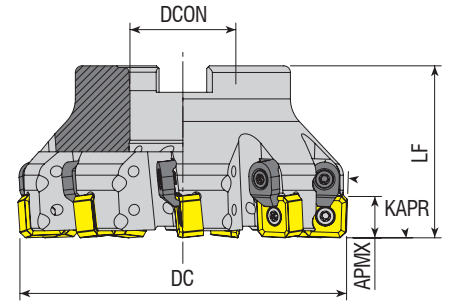

Takım Kodu Ordering Code Bestell-Bezeichnung	Stok Stock Lager	Takım Ölçüleri (mm) Dimension (mm) Abmessung (mm)					Kesici Uç Insert Wendeschneidplatte	Yedek Parçaları / Spare Parts / Ersatzteile				
		DC	ZEFP	DCON	LF	APMX		Sıkma Vidası Screw Schraube	Baskı Parçası Wedge Clamp Spannpratze	Baskı Vidası Clamp Screw Klemmschraube	Tork Anahtar Torx Key Torx-Schlüssel	Montaj Vidası Mounting Screw Befestigungsschraube
AFM88C-SN12...-D050-A22-Z05-H	●	50	5	22	40	11.5	SN.. 12..	1015-M4x11	ACK-05	4015-M4x11	80-T15	2508-M10x30
AFM88C-SN12...-D063-A22-Z06-H	●	63	6	22	40	11.5						
AFM88C-SN12...-D080-A27-Z07-H	●	80	7	27	50	11.5						
AFM88C-SN12...-D100-A32-Z09-H	●	100	9	32	52	11.5						

R: Sağ / Right / Rechts L: Sol/Left/Links

● Stokta / In Stock / Auf Lager ○ Stokta Yok / Non Stock Item / Kein Lagerartikel, Lieferzeit auf Anfrage

ISO Ucuna Uygun. / Compatible with ISO Insert. Kompatibel mit ISO Wendepplatten.

Sipariş Örneği/Ordering Example/Bestellbeispiel

1 ad./pcs./stück AFM88C-SN1206-D063-A22-Z06-H

Kesme Hesabı : S 367 / Cutting Calculation : P 367 / Schnitlberechnung : 367

Montaj Ölçüleri : S 364 / Mounting Reference : P 364 / Montagehinweis : 364



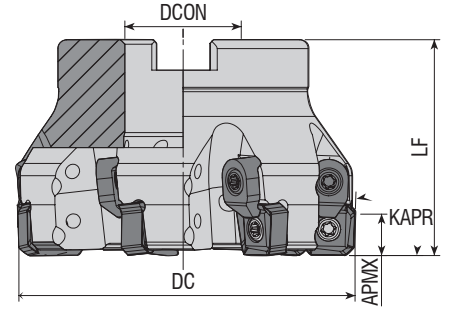

Takım Kodu Ordering Code Bestell-Bezeichnung	Stok Stock Lager	Takım Ölçüleri (mm) Dimension (mm) Abmessung (mm)					Kesici Uç Insert Wendeschneidplatte	Yedek Parçaları / Spare Parts / Ersatzteile				
		DC	ZEFP	DCON	LF	APMX		Sıkma Vidası Screw Schraube	Baskı Parçası Wedge Clamp Spannpratze	Baskı Vidası Clamp Screw Klemmschraube	Tork Anahtar Torx Key Torx-Schlüssel	Montaj Vidası Mounting Screw Befestigungsschraube
AFM88C-SN12Z-D063-A22-Z06-H	●	63	6	22	40	11.5	SNEG 1205..	4015-M4x11	ACK-05	4015-M4X11	80-T15	2508-M10x30
AFM88C-SN12Z-D080-A27-Z07-H	●	80	7	27	50	11.5						2510-M12x35

ZCC Ucuna Uygunur. / Compatible with ZCC Insert. Kompatibel mit ZCC Wendepatten.

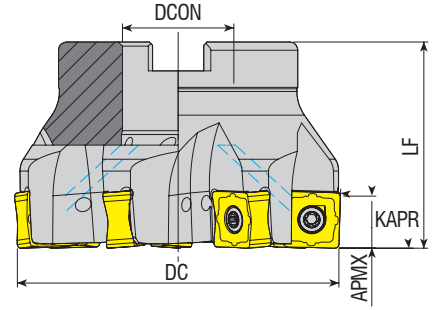

Takım Kodu Ordering Code Bestell-Bezeichnung	Stok Stock Lager	Takım Ölçüleri (mm) Dimension (mm) Abmessung (mm)					Kesici Uç Insert Wendeschneidplatte	Yedek Parçaları / Spare Parts / Ersatzteile				
		DC	ZEFP	DCON	LF	APMX		Sıkma Vidası Screw Schraube	Baskı Parçası Wedge Clamp Spannpratze	Baskı Vidası Clamp Screw Klemmschraube	Tork Anahtar Torx Key Torx-Schlüssel	Montaj Vidası Mounting Screw Befestigungsschraube
AFM89-SN1305I-D040-A16-Z04-H	●	40	4	16	40	10	SNMU 1305..	1015 M4x11	-	-	80-T15	2306-M8x37
AFM89-SN1305I-D050-A22-Z05-H	●	50	5	22	40	10						2508-M10x30
AFM89-SN1305I-D063-A22-Z06-H	●	63	6	22	40	10	SNMU 1305.. OXMT 0507..	1015 M4x11	-	-	80-T15	2510-M12x35
AFM89-SN1305I-D063-A22-Z07-H	●	63	7	22	40	10						2514-M16x35
AFM89-SN1305I-D080-A27-Z08-H	●	80	8	27	50	10						
AFM89-SN1305I-D100-A32-Z10-H	●	100	10	32	50	10						

R: Sağ / Right / Rechts L: Sol/Left/Links

● Stokta / In Stock / Auf Lager ○ Stokta Yok / Non Stock Item / Kein Lagerartikel, Lieferzeit auf Anfrage

ISCR Ucuna Uygunur. / Compatible with ISCR Insert. Kompatibel mit ISCR Wendepatten.

Sipariş Örneği/Ordering Example/Bestellbeispiel

1 ad./pcs./stück AFM88C-SN12Z-D063-A22-Z06-H

Kesme Hesabı : S 367 / Cutting Calculation : P 367 / Schnittberechnung : 367

Montaj Ölçüleri : S 364 / Mounting Reference : P 364 / Montagehinweis : 364

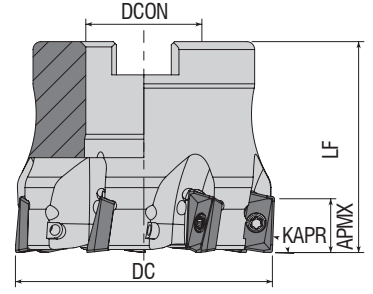

Takım Kodu Ordering Code Bestell-Bezeichnung	Stok Stock Lager	Takım Ölçüleri (mm) Dimension (mm) Abmessung (mm)					Kesici Uç Insert Wendeschneidplatte	Yedek Parçaları / Spare Parts / Ersatzteile		
		DC	ZEFP	DCON	LF	APMX		Sıkma Vidası Screw Schraube	Tork Anahtar Torx Key Torx-Schlüssel	Montaj Vidası Mounting Screw Befestigungsschraube
AFM90-AD10T3-D040-A16-Z06-H	●	40	6	16	40	10	ADMT 10T3..	3008-M2.5x6	80-T08	2506-M8x30
AFM90-AD10T3-D050-A22-Z07-H	●	50	7	22	40	10				2508-M10x30

WLTR Ucuna Uygunur. / Compatiple with WLTR Insert. Kompatibel mit WLTR Wendeplatten.

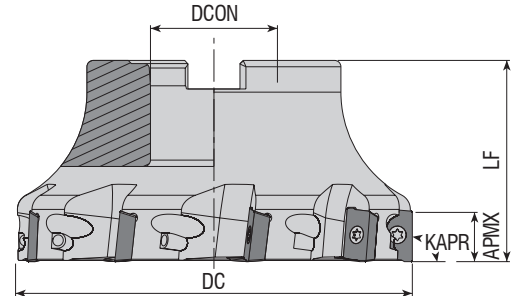

Takım Kodu Ordering Code Bestell-Bezeichnung	Stok Stock Lager	Takım Ölçüleri (mm) Dimension (mm) Abmessung (mm)					Kesici Uç Insert Wendeschneidplatte	Yedek Parçaları / Spare Parts / Ersatzteile		
		DC	ZEFP	DCON	LF	APMX		Sıkma Vidası Screw Schraube	Tork Anahtar Torx Key Torx-Schlüssel	Montaj Vidası Mounting Screw Befestigungsschraube
AFM90-AD1505-D040-A16-Z04-H	●	40	4	16	40	14.3	AD.. 1505..	4015-M4x11	80-T15	2506-M8x30
AFM90-AD1505-D050-A22-Z05-H	●	50	5	22	40	14.3				2508-M10x30
AFM90-AD1505-D063-A22-Z06-H	●	63	6	22	40	14.3				2510-M12x35
AFM90-AD1505-D080-A27-Z07-H	●	80	7	27	50	14.3				2514-M16x35
AFM90-AD1505-D100-A32-Z08-H	●	100	8	32	50	14.3				-
AFM90-AD1505-D125-B40-Z09	●	125	9	40	63	14.3				-

R: Sağ / Right / Rechts L: Sol/Left/Links  
● Stokta / In Stock / Auf Lager ○ Stokta Yok / Non Stock Item / Kein Lagerartikel, Lieferzeit auf Anfrage  
ISCR Ucuna Uygunur. / Compatiple with ISCR Insert. Kompatibel mit ISCR Wendeplatten.

Sipariş Örneği/Ordering Example/Bestellbeispiel  
1 ad./pcs./stück AFM90-AD10T3-D040-A16-Z06-H  
Kesme Hesabı : S 367 / Cutting Calculation : P 367 / Schnittberechnung : 367  
Montaj Ölçüleri : S 364 / Mounting Reference : P 364 / Montagehinweis : 364

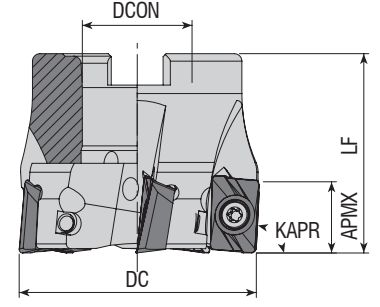

Takım Kodu Ordering Code Bestell-Bezeichnung	Stok Stock Lager	Takım Ölçüleri (mm) Dimension (mm) Abmessung (mm)					Kesici Uç Insert Wendeschneidplatte	Yedek Parçaları / Spare Parts / Ersatzteile		
		DC	ZEFP	DCON	LF	APMX		Sıkma Vidası Screw Schraube	Tork Anahtar Torx Key Torx-Schlüssel	Montaj Vidası Mounting Screw Befestigungsschraube
AFM90-AD1505D-D050-A22-Z05-H	●	50	5	22	40	14.3	ADKT 150508	4015-M4x11	80-T15	2508-M10x30
AFM90-AD1505D-D063-A27-Z06-H	●	63	6	27	50	14.3				2510-M12x35
AFM90-AD1505D-D080-A27-Z08-H	●	80	8	27	50	14.3				2514-M16x35
AFM90-AD1505D-D100-A32-Z08-H	●	100	8	32	50	14.3				-
AFM90-AD1505D-D125-B40-Z09	●	125	9	40	63	14.3				-

DJT Ucuna Uygundur. / Compatible with DJT Insert. Kompatibel mit DJT Wendeplatten.

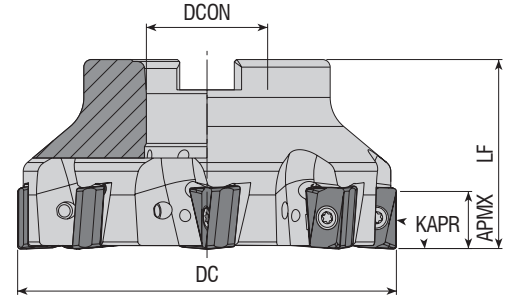

Takım Kodu Ordering Code Bestell-Bezeichnung	Stok Stock Lager	Takım Ölçüleri (mm) Dimension (mm) Abmessung (mm)					Kesici Uç Insert Wendeschneidplatte	Yedek Parçaları / Spare Parts / Ersatzteile					
		DC	ZEFP	DCON	LF	APMX		Sıkma Vidası Screw Schraube	Tork Anahtar Torx Key Torx-Schlüssel	Montaj Vidası Mounting Screw Befestigungsschraube			
AFM90-AN11-D040-A16-Z04-H	●	40	4	16	40	11	ANGX 1105..	4010-M3x8	80-T10	2506-M8x30			
AFM90-AN1506-D050-A22-Z04-H	●	50	4	22	40	14.5				2508-M10x30			
AFM90-AN1506-D063-A22-Z05-H	●	63	5	22	40	14.5				ANGX 1506..	4015-M4x12	80-T15	2510-M12x35
AFM90-AN1506-D080-A27-Z06-H	●	80	6	27	50	14.5							2514-M16x35
AFM90-AN1506-D100-A32-Z08-H	●	100	8	32	50	14.5							-
AFM90-AN1506-D125-B40-Z09	●	125	9	40	63	14.5							-
AFM90-AN1506-D160-C40-Z10	●	160	10	40	63	14.5							-

R: Sağ / Right / Rechts L: Sol/Left/Links  
● Stokta / In Stock / Auf Lager ○ Stokta Yok / Non Stock Item / Kein Lagerartikel, Lieferzeit auf Anfrage  
ZCC Ucuna Uygundur. / Compatible with ZCC Insert. Kompatibel mit ZCC Wendeplatten.

Sipariş Örneği/Ordering Example/Bestellbeispiel  
1 ad./pcs./stück AFM90-AD1505D-D050-A22-Z05-H  
Kesme Hesabı : S 367 / Cutting Calculation : P 367 / Schnittberechnung : 367  
Montaj Ölçüleri : S 364 / Mounting Reference : P 364 / Montagehinweis : 364

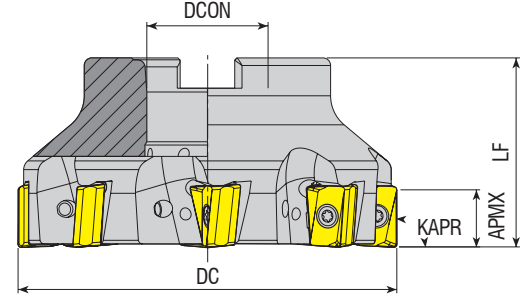

Takım Kodu Ordering Code Bestell-Bezeichnung	Stok Stock Lager	Takım Ölçüleri (mm) Dimension (mm) Abmessung (mm)					Kesici Uç Insert Wendeschneidplatte	Yedek Parçaları / Spare Parts / Ersatzteile		
		DC	ZEPF	DCON	LF	APMX		Sıkma Vidası Screw Schraube	Tork Anahtar Torx Key Torx-Schlüssel	Montaj Vidası Mounting Screw Befestigungsschraube
AFM90-AN1607-D050-A22-Z04-H	●	50	4	22	40	15	AN.X 1607..	4015-M4x11	80-T15	2508-M10x30
AFM90-AN1607-D063-A22-Z06-H	●	63	6	22	40	15				2510-M12x35
AFM90-AN1607-D080-A27-Z07-H	●	80	7	27	50	15				2514-M16x35
AFM90-AN1607-D100-A32-Z08-H	●	100	8	32	50	15				-
AFM90-AN1607-D125-B40-Z10	●	125	10	40	63	15				-

TGTC Ucuna Uygun. / Compatible with TGTC Insert. Kompatibel mit TGTC Wendeplatten.

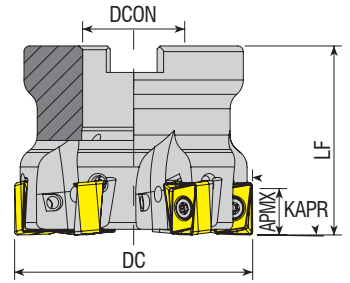

Takım Kodu Ordering Code Bestell-Bezeichnung	Stok Stock Lager	Takım Ölçüleri (mm) Dimension (mm) Abmessung (mm)					Kesici Uç Insert Wendeschneidplatte	Yedek Parçaları / Spare Parts / Ersatzteile		
		DC	ZEPF	DCON	LF	APMX		Sıkma Vidası Screw Schraube	Tork Anahtar Torx Key Torx-Schlüssel	Montaj Vidası Mounting Screw Befestigungsschraube
AFM90-AN12-D040-A16-Z04-H	●	40	4	16	40	12	ANKX 1205..	4015-M4x12	80-T15	2406-M8x30
AFM90-AN12-D050-A22-Z05-H	●	50	5	22	40	12				2508-M10x30
AFM90-AN12-D063-A27-Z06-H	●	63	6	27	50	12				2510-M12x35

R: Sağ / Right / Rechts L: Sol/Left/Links  
● Stokta / In Stock / Auf Lager ○ Stokta Yok / Non Stock Item / Kein Lagerartikel, Lieferzeit auf Anfrage  
ISCR Ucuna Uygun. / Compatible with ISCR Insert. Kompatibel mit ISCR Wendeplatten.

Sipariş Örneği/Ordering Example/Bestellbeispiel  
1 ad./pcs./stück AFM90-AN1607-D050-A22-Z04-H  
Kesme Hesabı : S 367 / Cutting Calculation : P 367 / Schnittberechnung : 367  
Montaj Ölçüleri : S 364 / Mounting Reference : P 364 / Montagehinweis : 364



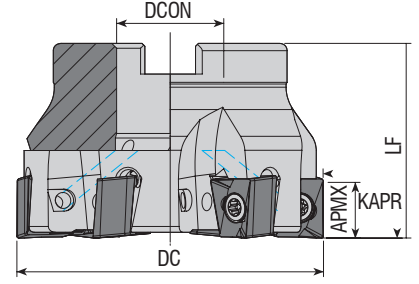

Takım Kodu Ordering Code Bestell-Bezeichnung	Stok Stock Lager	Takım Ölçüleri (mm) Dimension (mm) Abmessung (mm)					Kesici Uç Insert Wendeschneidplatte	Yedek Parçaları / Spare Parts / Ersatzteile		
		DC	ZEFP	DCON	LF	APMX		Sıkma Vidası Screw Schraube	Tork Anahtar Torx Key Torx-Schlüssel	Montaj Vidası Mounting Screw Befestigungsschraube
AFM90-AN1207-D040-A16-Z04-H	●	40	4	16	40	10	ANKX 1207..	4015-M4x11	80-T15	2506-M8x30
AFM90-AN1207-D050-A22-Z05-H	●	50	5	22	40	10				2508-M10x30
AFM90-AN1207-D063-A22-Z06-H	●	63	6	22	40	10				2510-M12x35
AFM90-AN1607X-D050-A22-Z04-H	●	50	4	22	40	15	ANKX 1607..	4015-M4x11	80-T15	2506-M8x30
AFM90-AN1607X-D063-A22-Z06-H	●	63	6	22	40	15				2508-M10x30
AFM90-AN1607X-D080-A27-Z07-H	●	80	7	27	50	15				2510-M12x35

XTC-GSC Ucuna Uygunudur. / Compatible with XTC-GSC Insert. Kompatibel mit XTC-GSC Wendepfetten.

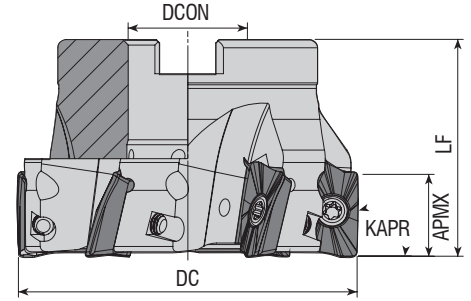

Takım Kodu Ordering Code Bestell-Bezeichnung	Stok Stock Lager	Takım Ölçüleri (mm) Dimension (mm) Abmessung (mm)					Kesici Uç Insert Wendeschneidplatte	Yedek Parçaları / Spare Parts / Ersatzteile		
		DC	ZEFP	DCON	LF	APMX		Sıkma Vidası Screw Schraube	Tork Anahtar Torx Key Torx-Schlüssel	Montaj Vidası Mounting Screw Befestigungsschraube
AFM90-A01236-D050-A22-Z05-H	●	50	5	22	40	10	AO.. 1236..	3008-M2.5x6	80-T08	2508-M10x30
AFM90-A01848-D050-A22-Z05-H	●	50	5	22	40	15	AO.. 1848..	4015-M4x11	80-T15	
AFM90-A01848-D063-A22-Z06-H	●	63	6	22	40	15				

R: Sağ / Right / Rechts L: Sol/Left/Links  
● Stokta / In Stock / Auf Lager ○ Stokta Yok / Non Stock Item / Kein Lagerartikel, Lieferzeit auf Anfrage  
MTSBH Ucuna Uygunudur. / Compatible with MTSBH Insert. Kompatibel mit MTSBH Wendepfetten.

Sipariş Örneği/Ordering Example/Bestellbeispiel  
1 ad./pcs./stück AFM90-AN1207-D040-A16-Z04-H  
Kesme Hesabı : S 367 / Cutting Calculation : P 367 / Schnittberechnung : 367  
Montaj Ölçüleri : S 364 / Mounting Reference : P 364 / Montagehinweis : 364

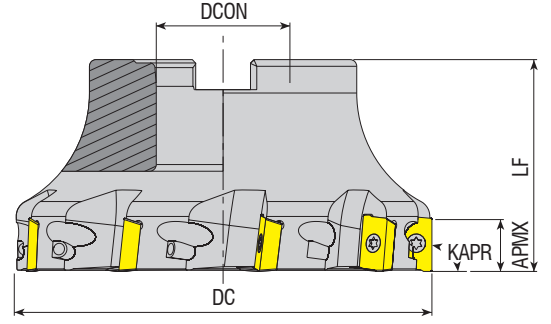

Takım Kodu Ordering Code Bestell-Bezeichnung	Stok Stock Lager	Takım Ölçüleri (mm) Dimension (mm) Abmessung (mm)					Kesici Uç Insert Wendeschneidplatte	Yedek Parçaları / Spare Parts / Ersatzteile		
		DC	ZEFP	DCON	LF	APMX		Sıkma Vidası Screw Schraube	Tork Anahtar Torx Key Torx-Schlüssel	Montaj Vidası Mounting Screw Befestigungsschraube
AFM90-AP10-D040-A16-Z05-H	●	40	5	16	40	10	AP. 1003.. ISO UCUNA UYGUNDUR. FOR ISO INSERT. FÜR ISO-WENDEPLATTE	3008-M2.5x6	80-T08	2506-M8x30
AFM90-AP10-D050-A22-Z06-H	●	50	6	22	40	10				2508-M10x30
AFM90-AP10-D063-A22-Z07-H	●	63	7	22	40	10				2510-M12x35
AFM90-AP10-D080-A27-Z08-H	●	80	8	27	50	10				2514-M16x35
AFM90-AP10-D100-A32-Z09-H	●	100	9	32	50	10				2506-M8x30
AFM90-AP16-D040-A16-Z04-H	●	40	4	16	40	16	AP. 1604.. ISO UCUNA UYGUNDUR. FOR ISO INSERT. FÜR ISO-WENDEPLATTE	4015-M4x11	80-T15	2508-M10x30
AFM90-AP16-D050-A22-Z05-H	●	50	5	22	40	16				2510-M12x35
AFM90-AP16-D052-A22-Z05-H	●	52	5	22	40	16				2506-M8x30
AFM90-AP16-D063-A22-Z06-H	●	63	6	22	40	16				2508-M10x30
AFM90-AP16-D080-A27-Z07-H	●	80	7	27	50	16				2510-M12x35
AFM90-AP16-D100-A32-Z08-H	●	100	8	32	50	16				2514-M16x35
AFM90-AP16-D125-B40-Z09	●	125	9	40	63	16				-
AFM90-AP16-D160-C40-Z10	●	160	10	40	63	16				-
AFM90-AP16-D200-C60-Z12	●	200	12	60	63	16				-
AFM90-AP16DJ-D050-A22-Z05-H	●	50	5	22	40	16				AP. 1604.. DJT UCUNA UYGUNDUR. FOR DJT INSERT. FÜR DJT-WENDEPLATTE
AFM90-AP16DJ-D063-A22-Z06-H	●	63	6	22	40	16	2510-M12x35			
AFM90-AP16DJ-D080-A27-Z07-H	●	80	7	27	50	16	2506-M8x30			
AFM90-AP16L-D050-A22-Z05-H	●	50	5	22	40	16	AP. 1604.. LMN UCUNA UYGUNDUR. FOR LMN INSERT. FÜR LMN-WENDEPLATTE	2508-M10x30		
AFM90-AP16L-D063-A22-Z06-H	●	63	6	22	40	16	2510-M12x35			
AFM90-AP16L-D080-A27-Z07-H	●	80	7	27	50	16	2506-M8x30			
AFM90-AP16P-D040-A16-Z04-H	●	40	4	16	40	16	AP. 1604.. PLBT UCUNA UYGUNDUR. FOR PLBT INSERT. FÜR PLBT-WENDEPLATTE	2508-M10x30		
AFM90-AP16P-D050-A22-Z05-H	●	50	5	22	40	16	2510-M12x35			
AFM90-AP16P-D063-A22-Z06-H	●	63	6	22	40	16	2514-M16x35			
AFM90-AP16P-D080-A27-Z07-H	●	80	7	27	50	16	2506-M8x30			
AFM90-AP16P-D100-A32-Z08-H	●	100	8	32	50	16	2508-M10x30			
AFM90-AP16A-D050-A22-Z05-H	●	50	5	22	40	15	AP. 1604.. ACHTK UCUNA UYGUNDUR. FOR ACHTK INSERT. FÜR ACHTK-WENDEPLATTE	2510-M12x35		
AFM90-AP16A-D063-A22-Z06-H	●	63	6	22	40	15	2514-M16x35			
AFM90-AP16A-D080-A27-Z07-H	●	80	7	27	50	15	-			
AFM90-AP16A-D100-A32-Z08-H	●	100	8	32	50	15	2506-M8x30			
AFM90-AP16A-D125-B40-Z09	●	125	9	40	63	15	2508-M10x30			
AFM90-AP16Y-D040-A16-Z04-H	●	40	4	16	40	16	AP. 1604.. YG UCUNA UYGUNDUR. FOR YG INSERT. FÜR YG-WENDEPLATTE	2510-M12x35		
AFM90-AP16Y-D050-A22-Z05-H	●	50	5	22	40	16	2514-M16x35			
AFM90-AP16Y-D063-A22-Z06-H	●	63	6	22	40	16	2506-M8x30			
AFM90-AP16Y-D080-A27-Z07-H	●	80	7	27	50	16	2508-M10x30			
AFM90-AP16Y-D100-A32-Z08-H	●	100	8	32	50	16	2510-M12x35			

R: Sağ / Right / Rechts L: Sol/Left/Links

● Stokta / In Stock / Auf Lager ○ Stokta Yok / Non Stock Item / Kein Lagerartikel, Lieferzeit auf Anfrage

Sipariş Örneği/Ordering Example/Bestellbeispiel

1 ad./pcs./stück AFM90-AP10-D040-A16-Z05-H

Kesme Hesabı : S 367 / Cutting Calculation : P 367 / Schnittberechnung : 367

Montaj Ölçüleri : S 364 / Mounting Reference : P 364 / Montagehinweis : 364

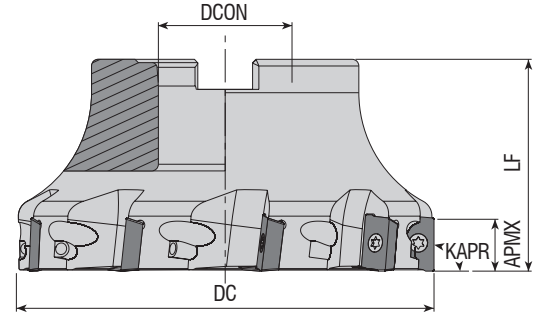

Takım Kodu Ordering Code Bestell-Bezeichnung	Stok Stock Lager	Takım Ölçüleri (mm) Dimension (mm) Abmessung (mm)					Kesici Uç Insert Wendeschneidplatte	Yedek Parçaları / Spare Parts / Ersatzteile		
		DC	ZEFP	DCON	LF	APMX		Sıkma Vidası Screw Schraube	Tork Anahtar Torx Key Torx-Schlüssel	Montaj Vidası Mounting Screw Befestigungsschraube
AFM90-AP1705-D050-A22-Z05-H	●	50	5	22	40	16	AP. 1705..	4015-M4x11	80-T15	2508-M10x30 2510-M12x35 2514-M16x35
AFM90-AP1705-D063-A22-Z06-H	●	63	6	22	40	16				
AFM90-AP1705-D080-A27-Z07-H	●	80	7	27	50	16				
AFM90-AP1705-D100-A32-Z08-H	●	100	8	32	50	16				

TGTC Ucuna Uygun. / Compatible with TGTC Insert. Kompatibel mit TGTC Wendepplatten.

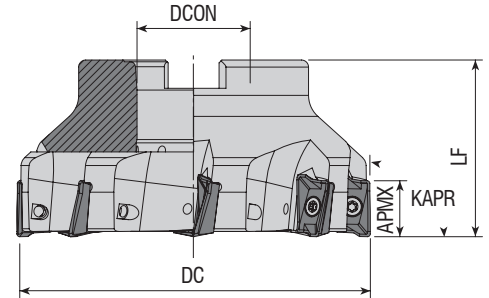

Takım Kodu Ordering Code Bestell-Bezeichnung	Stok Stock Lager	Takım Ölçüleri (mm) Dimension (mm) Abmessung (mm)					Kesici Uç Insert Wendeschneidplatte	Yedek Parçaları / Spare Parts / Ersatzteile		
		DC	ZEFP	DCON	LF	APMX		Sıkma Vidası Screw Schraube	Tork Anahtar Torx Key Torx-Schlüssel	Montaj Vidası Mounting Screw Befestigungsschraube
AFM90-AX1235-D040-A16-Z06-H	●	40	6	16	40	10	AX.T 1235..	3108-M3x6	80-T08	2506-M8x30 2508-M10x30 2510-M12x35
AFM90-AX1235-D050-A22-Z07-H	●	50	7	22	40	10				
AFM90-AX1235-D063-A22-Z08-H	●	63	8	22	40	10				
AFM90-AX1235-D080-A27-Z10-H	●	80	10	27	50	10				
AFM90-AX1705-D040-A16-Z04-H	●	40	4	16	40	14	AX.T 1705..	4015-M4x11	80-T15	2506-M8x30 2508-M10x30 2510-M12x35 2514-M16x35
AFM90-AX1705-D050-A22-Z05-H	●	50	5	22	40	14				
AFM90-AX1705-D063-A22-Z06-H	●	63	6	22	40	14				
AFM90-AX1705-D080-A27-Z07-H	●	80	7	27	50	14				
AFM90-AX1705-D100-A32-Z08-H	●	100	8	32	50	14				

R: Sağ / Right / Rechts L: Sol/Left/Links

● Stokta / In Stock / Auf Lager ○ Stokta Yok / Non Stock Item / Kein Lagerartikel, Lieferzeit auf Anfrage  
SMTM Ucuna Uygun. / Compatible with SMTM Insert. Kompatibel mit SMTM Wendepplatten.

Sipariş Örneği/Ordering Example/Bestellbeispiel  
1 ad./pcs./stück AFM90-AP1705-D050-A22-Z05-H  
Kesme Hesabı : S 367 / Cutting Calculation : P 367 / Schnittberechnung : 367  
Montaj Ölçüleri : S 364 / Mounting Reference : P 364 / Montagehinweis : 364

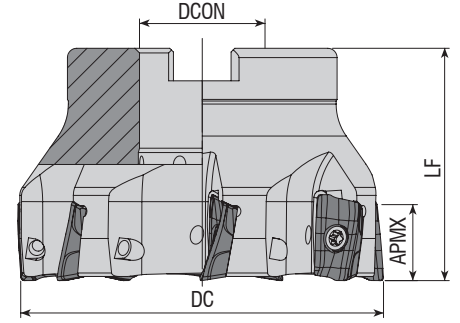

Takım Kodu Ordering Code Bestell-Bezeichnung	Stok Stock Lager	Takım Ölçüleri (mm) Dimension (mm) Abmessung (mm)					Kesici Uç Insert Wendeschneidplatte	Yedek Parçaları / Spare Parts / Ersatzteile		
		DC	ZEFP	DCON	LF	APMX		Sıkma Vidası Screw Schraube	Tork Anahtar Torx Key Torx-Schlüssel	Montaj Vidası Mounting Screw Befestigungsschraube
AFM90-BD11T3-D040-A16-Z04-H	●	40	4	16	40	10	BDMT 11T3..	3008-M2.5x6	80-T08	2506-M8x30
AFM90-BD11T3-D040-A16-Z05-H	●	40	5	16	40	10				
AFM90-BD11T3-D050-A22-Z05-H	●	50	5	22	40	10				
AFM90-BD11T3-D063-A22-Z06-H	●	63	6	22	40	10	BDMT 1704..	4015-M4x11	80-T15	2508-M10x30
AFM90-BD1704-D050-A22-Z04-H	●	50	4	22	40	15.7				
AFM90-BD1704-D050-A22-Z05-H	●	50	5	22	40	15.7				
AFM90-BD1704-D063-A22-Z06-H	●	63	6	22	40	15.7				
AFM90-BD1704-D080-A27-Z06-H	●	80	6	27	50	15.7				
AFM90-BD1704-D080-A27-Z07-H	●	80	7	27	50	15.7				
AFM90-BD1704-D100-A32-Z07-H	●	100	7	32	50	15.7				

KYCR Ucuna Uygundur. / Compatible with KYCR Insert. Kompatibel mit KYCR Wendeplatten.

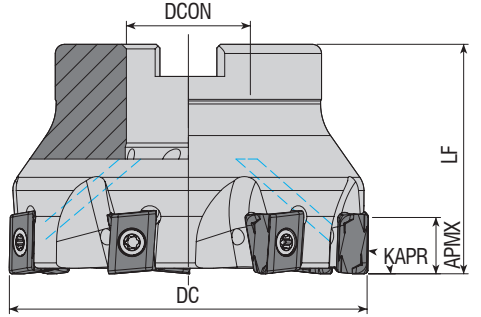

Takım Kodu Ordering Code Bestell-Bezeichnung	Stok Stock Lager	Takım Ölçüleri (mm) Dimension (mm) Abmessung (mm)					Kesici Uç Insert Wendeschneidplatte	Yedek Parçaları / Spare Parts / Ersatzteile		
		DC	ZEFP	DCON	LF	APMX		Sıkma Vidası Screw Schraube	Tork Anahtar Torx Key Torx-Schlüssel	Montaj Vidası Mounting Screw Befestigungsschraube
AFM90-LN1506X-D063-A22-Z06	●	63	6	22	40	7	LNMT 1506..	3015-M4x11	80-T15	2508-M10x30
AFM90-LN1506X-D080-A27-Z07	●	80	7	27	50	7				
AFM90-LN1506X-D100-A32-Z08	●	100	8	32	50	7				

R: Sağ / Right / Rechts L: Sol/Left/Links  
● Stokta / In Stock / Auf Lager ○ Stokta Yok / Non Stock Item / Kein Lagerartikel, Lieferzeit auf Anfrage  
XTC-GSC Ucuna Uygundur. / Compatible with XTC-GSC Insert. Kompatibel mit XTC-GSC Wendeplatten.

Sipariş Örneği/Ordering Example/Bestellbeispiel  
1 ad./pcs./stück AFM90-BD11T3-D040-A16-Z04-H  
Kesme Hesabı : S 367 / Cutting Calculation : P 367 / Schnittberechnung : 367  
Montaj Ölçüleri : S 364 / Mounting Reference : P 364 / Montagehinweis : 364



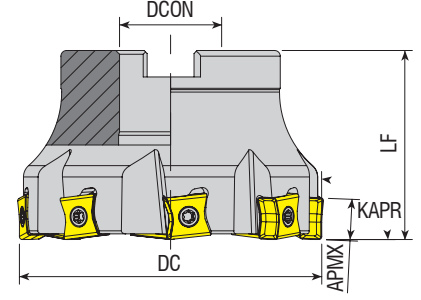

Takım Kodu Ordering Code Bestell-Bezeichnung	Stok Stock Lager	Takım Ölçüleri (mm) Dimension (mm) Abmessung (mm)					Kesici Uç Insert Wendeschneidplatte	Yedek Parçaları / Spare Parts / Ersatzteile		
		DC	ZEFP	DCON	LF	APMX		Sıkma Vidası Screw Schraube	Tork Anahtar Torx Key Torx-Schlüssel	Montaj Vidası Mounting Screw Befestigungsschraube
AFM90-LN1106-D050-A22-Z05	●	50	5	22	40	10	LNMT 1106..	4015-M3.5x11	80-T15	2508-M10x30
AFM90-LN1106-D063-A22-Z06	●	63	6	22	40	10				2510-M12x35
AFM90-LN1106-D080-A27-Z08	●	80	8	27	50	10				2514-M16x35
AFM90L-LN1106-D080-A27-Z08	●	80	8	27	50	10				-
AFM90-LN1106-D100-A32-Z09	●	100	9	32	50	10				2506-M8x30
AFM90L-LN1106-D100-A32-Z09	●	100	9	32	50	10				2508-M10x30
AFM90-LN1106-D125-B40-Z10	●	125	10	40	63	10	T490 LNMT 1306..	4015-M4x11	80-T15	2510-M12x35
AFM90-LN1306-D040-A16-Z04-H	●	40	4	16	40	12.5				2514-M16x35
AFM90-LN1306-D050-A22-Z05-H	●	50	5	22	40	12.5				2506-M8x30
AFM90-LN1306-D063-A22-Z06-H	●	63	6	22	40	12.5				2508-M10x30
AFM90-LN1306-D080-A27-Z07-H	●	80	7	27	50	12.5	LNMT 1506..	4015-M4x11	80-T15	2510-M12x35
AFM90-LN1306-D100-A32-Z08-H	●	100	8	32	50	12.5				2514-M16x35
AFM90L-LN1506-D040-A16-Z04	●	40	4	16	40	14				2506-M8x30
AFM90-LN1506-D040-A16-Z04	○	40	4	16	40	14				2508-M10x30
AFM90-LN1506-D050-A22-Z05	○	50	5	22	40	14	T490 LNHT 1607..	4420-M5x14	80-T20	2510-M12x35
AFM90-LN1506-D063-A22-Z06	○	63	6	22	40	14				2508-M10x30
AFM90-LN1506-D080-A27-Z07	○	80	7	27	50	14				2510-M12x35
AFM90-LN1607-D050-A22-Z03-H	●	50	3	22	40	16				2514-M16x35
AFM90-LN1607-D063-A22-Z04-H	○	63	4	22	40	16	T490 LNHT 1607..	4420-M5x14	80-T20	2508-M10x30
AFM90-LN1607-D080-A27-Z05-H	●	80	5	27	50	16				2510-M12x35
AFM90-LN1607-D100-A32-Z06-H	●	100	6	32	50	16				2514-M16x35

R: Sağ / Right / Rechts L: Sol/Left/Links

● Stokta / In Stock / Auf Lager ○ Stokta Yok / Non Stock Item / Kein Lagerartikel, Lieferzeit auf Anfrage  
ISCR Ucuna Uygunudur. / Compatible with ISCR Insert. Kompatibel mit ISCR Wendepfatten.

Sipariş Örneği/Ordering Example/Bestellbeispiel

1 ad./pcs./stück AFM90-LN1106-D050-A22-Z05

Kesme Hesabı : S 367 / Cutting Calculation : P 367 / Schnittberechnung : 367

Montaj Ölçüleri : S 364 / Mounting Reference : P 364 / Montagehinweis : 364

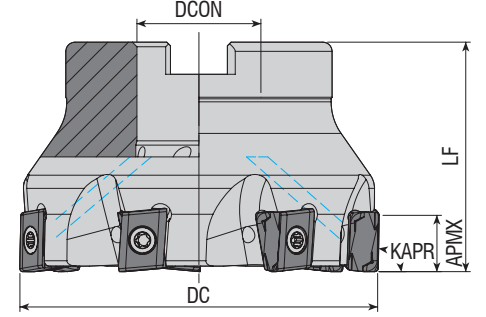

Takım Kodu Ordering Code Bestell-Bezeichnung	Stok Stock Lager	Takım Ölçüleri (mm) Dimension (mm) Abmessung (mm)					Kesici Uç Insert Wendeschneidplatte	Yedek Parçaları / Spare Parts / Ersatzteile		
		DC	ZEFP	DCON	LF	APMX		Sıkma Vidası Screw Schraube	Tork Anahtar Torx Key Torx-Schlüssel	Montaj Vidası Mounting Screw Befestigungsschraube
AFM90-LN1306W-D050-A22-Z05-H	●	50	5	22	40	12	LNHU 1306..	4115-M4x12	80-T15	2508-M10x30
AFM90-LN1306W-D063-A22-Z06-H	●	63	6	22	40	12				2510-M12x35
AFM90-LN1306W-D080-A27-Z07-H	●	80	7	27	50	12				

WLTR Ucuna Uygunur. / Compatiple with WLTR Insert. Kompatibel mit WLTR Wendeplatten.

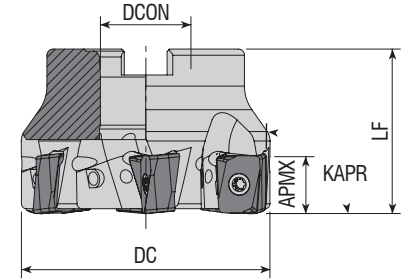

Takım Kodu Ordering Code Bestell-Bezeichnung	Stok Stock Lager	Takım Ölçüleri (mm) Dimension (mm) Abmessung (mm)					Kesici Uç Insert Wendeschneidplatte	Yedek Parçaları / Spare Parts / Ersatzteile		
		DC	ZEFP	DCON	LF	APMX		Sıkma Vidası Screw Schraube	Tork Anahtar Torx Key Torx-Schlüssel	Montaj Vidası Mounting Screw Befestigungsschraube
AFM90-LN1307-D050-A22-Z04-H	●	50	4	22	40	13	LNGX 1307..	1315-M4x11	80-T15	2508-M10x30
AFM90-LN1307-D063-A22-Z06-H	●	63	6	22	40	13				2510-M12x35
AFM90-LN1307-D080-A27-Z07-H	●	80	7	27	50	13				2514-M16x35
AFM90-LN1307-D100-A32-Z08-H	●	100	8	32	50	13				

R: Sağ / Right / Rechts L: Sol/Left/Links

● Stokta / In Stock / Auf Lager ○ Stokta Yok / Non Stock Item / Kein Lagerartikel, Lieferzeit auf Anfrage  
WLTR Ucuna Uygunur. / Compatiple with WLTR Insert. Kompatibel mit WLTR Wendeplatten.

Sipariş Örneği/Ordering Example/Bestellbeispiel

1 ad./pcs./stück AFM90-LN1306W-D050-A22-Z05-H

Kesme Hesabı : S 367 / Cutting Calculation : P 367 / Schnittberechnung : 367

Montaj Ölçüleri : S 364 / Mounting Reference : P 364 / Montagehinweis : 364

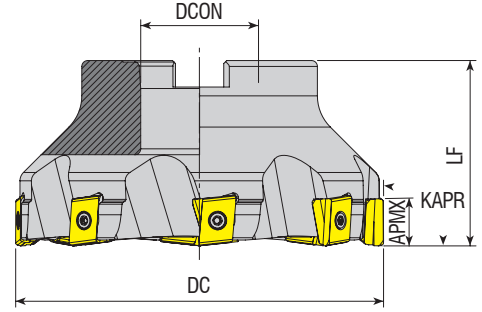

Takım Kodu Ordering Code Bestell-Bezeichnung	Stok Stock Lager	Takım Ölçüleri (mm) Dimension (mm) Abmessung (mm)					Kesici Uç Insert Wendeschneidplatte	Yedek Parçaları / Spare Parts / Ersatzteile		
		DC	ZEFP	DCON	LF	APMX		Sıkma Vidası Screw Schraube	Tork Anahtar Torx Key Torx-Schlüssel	Montaj Vidası Mounting Screw Befestigungsschraube
AFM90-LN15Z-D050-A22-Z04	●	50	4	22	40	15	LNKT 1506..	4015-M4x11	80-T15	2508-M10x30
AFM90-LN15Z-D063-A22-Z05	●	63	5	22	40	15				2510-M12x35
AFM90-LN15Z-D080-A27-Z06	●	80	6	27	50	15				2514-M16x35
AFM90-LN15Z-D100-A32-Z07	●	100	7	32	50	15				-
AFM90-LN15Z-D125-B40-Z08	●	125	8	40	63	15				-

ZCC Ucuna Uygunudur. / Compatible with ZCC Insert. Kompatibel mit ZCC Wendeplatten.

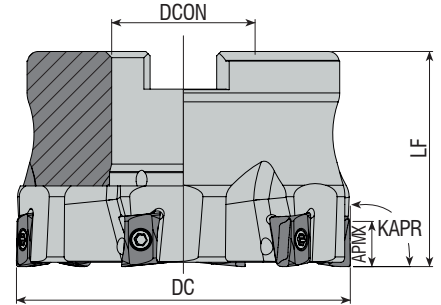

Takım Kodu Ordering Code Bestell-Bezeichnung	Stok Stock Lager	Takım Ölçüleri (mm) Dimension (mm) Abmessung (mm)					Kesici Uç Insert Wendeschneidplatte	Yedek Parçaları / Spare Parts / Ersatzteile		
		DC	ZEFP	DCON	LF	APMX		Sıkma Vidası Screw Schraube	Tork Anahtar Torx Key Torx-Schlüssel	Montaj Vidası Mounting Screw Befestigungsschraube
AFM90-L008-D040-A16-Z06-H	●	40	6	16	40	2	LOEX 0804..	3008-M2.5x8	80-T08	2506-M8x30
AFM90-L008-D050-A22-Z07-H	●	50	7	22	40	2				2508-M10x30
AFM90-L008-D063-A27-Z06-H	●	63	6	27	40	2				2510-M12x35

R: Sağ / Right / Rechts L: Sol/Left/Links

● Stokta / In Stock / Auf Lager ○ Stokta Yok / Non Stock Item / Kein Lagerartikel, Lieferzeit auf Anfrage  
SC Ucuna Uygunudur. / Compatible with SC Insert. Kompatibel mit SC Wendeplatten.

Sipariş Örneği/Ordering Example/Bestellbeispiel

1 ad./pcs./stück AFM90-LN15Z-D050-A22-Z04

Kesme Hesabı : S 367 / Cutting Calculation : P 367 / Schnittberechnung : 367

Montaj Ölçüleri : S 364 / Mounting Reference : P 364 / Montagehinweis : 364

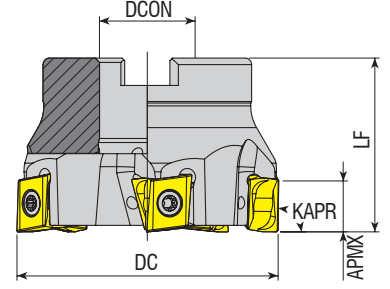

Takım Kodu Ordering Code Bestell-Bezeichnung	Stok Stock Lager	Takım Ölçüleri (mm) Dimension (mm) Abmessung (mm)					Kesici Uç Insert Wendeschneidplatte	Yedek Parçaları / Spare Parts / Ersatzteile					
		DC	ZEFP	DCON	LF	APMX		Sıkma Vidası Screw Schraube	Tork Anahtar Torx Key Torx-Schlüssel	Montaj Vidası Mounting Screw Befestigungsschraube			
AFM90-L01207-D040-A16-Z04-H	●	40	4	16	40	11	LOGU 1207..						
AFM90-L01207-D050-A22-Z05-H	●	50	5	22	40	11					3015-M4x11	80-T15	2506-M8x30
AFM90-L01207-D063-A22-Z05-H	●	63	5	22	40	11							2508-M10x30

MTSBSH Ucuna Uygun. / Compatiple with MTSBSH Insert. Kompatibel mit MTSBSH Wendeplatten.

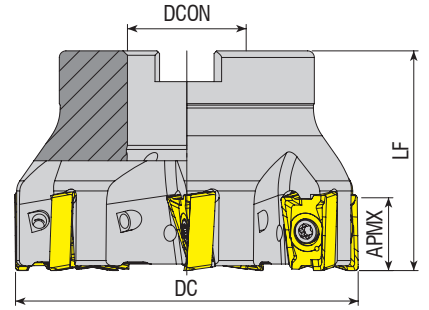

Takım Kodu Ordering Code Bestell-Bezeichnung	Stok Stock Lager	Takım Ölçüleri (mm) Dimension (mm) Abmessung (mm)					Kesici Uç Insert Wendeschneidplatte	Yedek Parçaları / Spare Parts / Ersatzteile					
		DC	ZEFP	DCON	LF	APMX		Sıkma Vidası Screw Schraube	Tork Anahtar Torx Key Torx-Schlüssel	Montaj Vidası Mounting Screw Befestigungsschraube			
AFM90-LN15T6-D050-A22-Z05-H	●	50	5	22	40	15.5	LNGU 15T6..						
AFM90-LN15T6-D063-A22-Z06-H	●	63	6	22	40	15.5					4015-M4x12	80-T15	2508-M10x30
AFM90-LN15T6-D080-A27-Z07-H	●	80	7	27	50	15.5							2510-M12x35

R: Sağ / Right / Rechts L: Sol/Left/Links  
● Stokta / In Stock / Auf Lager ○ Stokta Yok / Non Stock Item / Kein Lagerartikel, Lieferzeit auf Anfrage  
KNMTL Ucuna Uygun. / Compatiple with KNMTL Insert. Kompatibel mit KNMTL Wendeplatten.

Sipariş Örneği/Ordering Example/Bestellbeispiel  
1 ad./pcs./stück AFM90-L01207-D040-A16-Z04-H  
Kesme Hesabı : S 367 / Cutting Calculation : P 367 / Schnittberechnung : 367  
Montaj Ölçüleri : S 364 / Mounting Reference : P 364 / Montagehinweis : 364



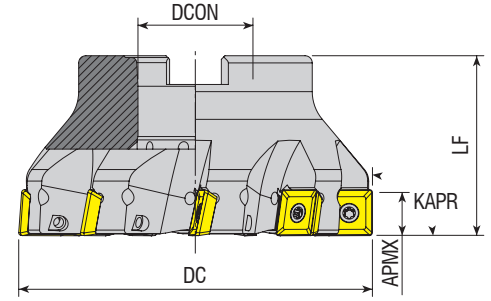

Takım Kodu Ordering Code Bestell-Bezeichnung	Stok Stock Lager	Takım Ölçüleri (mm) Dimension (mm) Abmessung (mm)					Kesici Uç Insert Wendeschneidplatte	Yedek Parçaları / Spare Parts / Ersatzteile		
		DC	ZEFP	DCON	LF	APMX		Sıkma Vidası Screw Schraube	Tork Anahtar Torx Key Torx-Schlüssel	Montaj Vidası Mounting Screw Befestigungsschraube
AFM90-R290.12-D050-A22-Z04-H	●	50	4	22	40	10.7	R290-12T3..	4015-M3.5x11	80-T15	2508-M10x30
AFM90-R290.12-D063-A22-Z05-H	●	63	5	22	40	10.7				2510-M12x35
AFM90-R290.12-D080-A27-Z07-H	●	80	7	27	50	10.7				2514-M16x35
AFM90-R290.12-D100-A32-Z09-H	●	100	9	32	50	10.7				-
AFM90-R290.12-D125-B40-Z11	●	125	11	40	63	10.7				-

SNDVK Ucuna Uygunur. / Compatible with SNDVK Insert. Kompatibel mit SNDVK Wendepplatten.

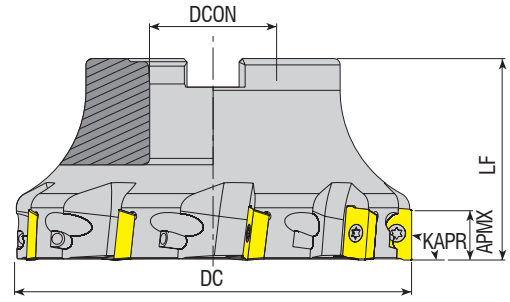

Takım Kodu Ordering Code Bestell-Bezeichnung	Stok Stock Lager	Takım Ölçüleri (mm) Dimension (mm) Abmessung (mm)					Kesici Uç Insert Wendeschneidplatte	Yedek Parçaları / Spare Parts / Ersatzteile		
		DC	ZEFP	DCON	LF	APMX		Sıkma Vidası Screw Schraube	Tork Anahtar Torx Key Torx-Schlüssel	Montaj Vidası Mounting Screw Befestigungsschraube
AFM90-R390.11-D040-A16-Z05-H	●	40	5	16	40	10	R390-11T3..	3008-M2.5x6	80-T08	2506-M8x30
AFM90-R390.11-D050-A22-Z06-H	●	50	6	22	40	10				2508-M10x30
AFM90-R390.11-D063-A22-Z07-H	●	63	7	22	40	10				2510-M12x35
AFM90-R390.11-D080-A27-Z09-H	●	80	9	27	50	10				2506-M8x30
AFM90-R390.17-D040-A16-Z04-H	●	40	4	16	40	15.4	R390-1704..	4015-M3.5x11	80-T15	2508-M10x30
AFM90-R390.17-D050-A22-Z05-H	●	50	5	22	40	15.4				2510-M12x35
AFM90-R390.17-D063-A22-Z06-H	●	63	6	22	40	15.4				2514-M16x35
AFM90-R390.17-D080-A27-Z07-H	●	80	7	27	50	15.4				-
AFM90-R390.17-D100-A32-Z08-H	●	100	8	32	50	15.4				2508-M10x30
AFM90-R390.17-D125-B40-Z09	●	125	9	40	63	15.4	R390-1806..	4015-M4x11	80-T15	2510-M12x35
AFM90-R390.18-D050-A22-Z04-H	●	50	4	22	40	15.4				2514-M16x35
AFM90-R390.18-D063-A22-Z05-H	●	63	5	22	40	15.4				-
AFM90-R390.18-D080-A27-Z06-H	●	80	6	27	50	15.4				2508-M10x30
AFM90-R390.18-D100-A32-Z07-H	●	100	7	32	50	15.4	R390-1806..	4015-M4x11	80-T15	2510-M12x35
AFM90-R390.18-D125-B40-Z08	●	125	8	40	63	15.4				2514-M16x35

R: Sağ / Right / Rechts L: Sol/Left/Links

● Stokta / In Stock / Auf Lager ○ Stokta Yok / Non Stock Item / Kein Lagerartikel, Lieferzeit auf Anfrage  
SNDVK Ucuna Uygunur. / Compatible with SNDVK Insert. Kompatibel mit SNDVK Wendepplatten.

Sipariş Örneği/Ordering Example/Bestellbeispiel  
1 ad./pcs./stück AFM90-R290.12-D050-A22-Z04-H  
Kesme Hesabı : S 367 / Cutting Calculation : P 367 / Schnittberechnung : 367  
Montaj Ölçüleri : S 364 / Mounting Reference : P 364 / Montagehinweis : 364

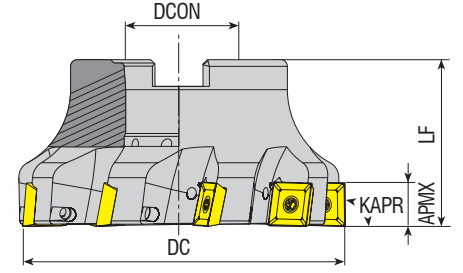

Takım Kodu Ordering Code Bestell-Bezeichnung	Stok Stock Lager	Takım Ölçüleri (mm) Dimension (mm) Abmessung (mm)					Kesici Uç Insert Wendeschneidplatte	Yedek Parçaları / Spare Parts / Ersatzteile		
		DC	ZEFP	DCON	LF	APMX		Sıkma Vidası Screw Schraube	Tork Anahtar Torx Key Torx-Schlüssel	Montaj Vidası Mounting Screw Befestigungsschraube
AFM90-490R08-D063-A22-Z06-H	●	63	6	22	40	5.5				
AFM90-490R14-D050-A22-Z04-H	●	50	4	22	40	10				
AFM90-490R14-D063-A22-Z05-H	●	63	5	22	40	10				
AFM90-490R14-D080-A27-Z07-H	●	80	7	27	50	10				
AFM90-490R14-D100-A32-Z07-H	●	100	7	32	50	10				
AFM90-490R14-D125-B40-Z08	●	125	8	40	63	10				
AFM90-490R14-D160-C40-Z12	●	160	12	40	63	10				
AFM90-490R14-D200-C60-Z16	●	200	16	60	63	10				

SNDVK Ucuna Uygunur. / Compatible with SNDVK Insert. Kompatibel mit SNDVK Wendepfatten.

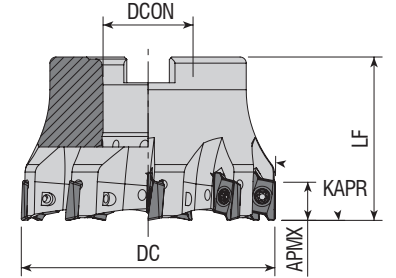

Takım Kodu Ordering Code Bestell-Bezeichnung	Stok Stock Lager	Takım Ölçüleri (mm) Dimension (mm) Abmessung (mm)					Kesici Uç Insert Wendeschneidplatte	Yedek Parçaları / Spare Parts / Ersatzteile		
		DC	ZEFP	DCON	LF	APMX		Sıkma Vidası Screw Schraube	Tork Anahtar Torx Key Torx-Schlüssel	Montaj Vidası Mounting Screw Befestigungsschraube
AFM90-RT10-D040-A16-Z06-H	●	40	6	16	40	10				
AFM90-RT10-D050-A22-Z07-H	●	50	7	22	40	10				
AFM90-RT10-D063-A22-Z09-H	●	63	9	22	40	10				

R: Sağ / Right / Rechts L: Sol/Left/Links  
● Stokta / In Stock / Auf Lager ○ Stokta Yok / Non Stock Item / Kein Lagerartikel, Lieferzeit auf Anfrage  
SFTY Ucuna Uygunur. / Compatible with SFTY Insert. Kompatibel mit SFTY Wendepfatten.

Sipariş Örneği/Ordering Example/Bestellbeispiel  
1 ad./pcs./stück AFM90-490R08-D063-A22-Z06-H  
Kesme Hesabı : S 367 / Cutting Calculation : P 367 / Schnittberechnung : 367  
Montaj Ölçüleri : S 364 / Mounting Reference : P 364 / Montagehinweis : 364

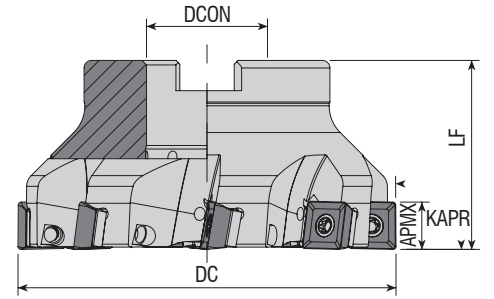

Takım Kodu Ordering Code Bestell-Bezeichnung	Stok Stock Lager	Takım Ölçüleri (mm) Dimension (mm) Abmessung (mm)					Kesici Uç Insert Wendeschneidplatte	Altlık Screw Unterlage	Baskı Parçası Wedge Clamp Spannpratze	Sıkma Vidası Screw Schraube	Tork Anahtar Torx Key Torx-Schlüssel	Montaj Vidası Mounting Screw Befestigungsschraube
		DC	ZEFP	DCON	LF	APMX						
AFM90S-SD1204-D050-A22-Z04-H	●	50	4	22	40	11	SDMT 1204..	AASD-3-0001	AAV-08-M3.5x8	4015-M3.5x12	80-T15	2408-M10x30
AFM90S-SD1204-D063-A22-Z05-H	●	63	5	22	40	11			2508-M10x30			
AFM90S-SD1204-D080-A27-Z06-H	●	80	6	27	50	11			2510-M12x35			
AFM90S-SD1204-D100-A32-Z08-H	●	100	8	32	50	11			2514-M16x35			
AFM90S-SD1204-D125-B40-Z10	●	125	10	40	63	11			-			
AFM90S-SD1204-D160-C40-Z12	●	160	12	40	63	11			-			

DJT Ucuna Uygunur. / Compatiple with DJT Insert. Kompatibel mit DJT Wendeplatten.

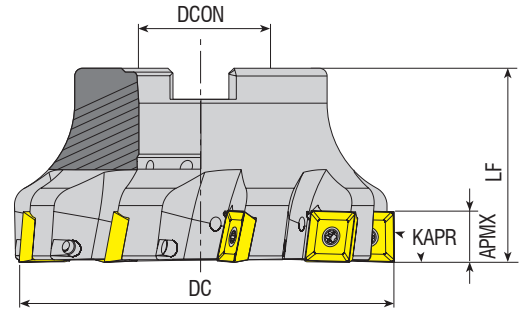

Takım Kodu Ordering Code Bestell-Bezeichnung	Stok Stock Lager	Takım Ölçüleri (mm) Dimension (mm) Abmessung (mm)					Kesici Uç Insert Wendeschneidplatte	Sıkma Vidası Screw Schraube	Tork Anahtar Torx Key Torx-Schlüssel	Montaj Vidası Mounting Screw Befestigungsschraube
		DC	ZEFP	DCON	LF	APMX				
AFM90-SD09M4-D040-A16-Z04-H	●	40	4	16	40	9	SD.. 09M4..	4015-M3.5x11	80-T15	2406-M8x30
AFM90-SD09M4-D050-A22-Z05-H	●	50	5	22	40	9				2508-M10x30
AFM90-SD09M4-D063-A22-Z06-H	●	63	6	22	40	9				2510-M12x35
AFM90-SD1305-D050-A22-Z04-H	●	50	4	22	40	13	SD.. 1305..	1020-M5x11	80-T20	2408-M10x30
AFM90-SD1305-D063-A22-Z05-H	●	63	5	22	40	13				2508-M10x30
AFM90-SD1305-D080-A27-Z06-H	●	80	6	27	50	13				2510-M12x35
AFM90-SD1305-D100-A32-Z07-H	●	100	7	32	50	13				-
AFM90-SD1305-D125-B40-Z08	●	125	8	40	63	13				-
AFM90-SD1305-D160-C40-Z10	●	160	10	40	63	13				-

R: Sağ / Right / Rechts L: Sol/Left/Links  
● Stokta / In Stock / Auf Lager ○ Stokta Yok / Non Stock Item / Kein Lagerartikel, Lieferzeit auf Anfrage  
KRLY Ucuna Uygunur. / Compatiple with KRLY Insert. Kompatibel mit KRLY Wendeplatten.

Sipariş Örneği/Ordering Example/Bestellbeispiel  
1 ad./pcs./stück AFM90S-SD1204-D050-A22-Z04-H  
Kesme Hesabı : S 367 / Cutting Calculation : P 367 / Schnittberechnung : 367  
Montaj Ölçüleri : S 364 / Mounting Reference : P 364 / Montagehinweis : 364

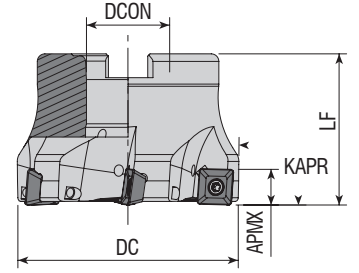

Takım Kodu Ordering Code Bestell-Bezeichnung	Stok Stock Lager	Takım Ölçüleri (mm) Dimension (mm) Abmessung (mm)					Kesici Uç Insert Wendeschneidplatte	Yedek Parçaları / Spare Parts / Ersatzteile			
		DC	ZEFP	DCON	LF	APMX		Sıkma Vidası Screw Schraube	Tork Anahtar Torx Key Torx-Schlüssel	Montaj Vidası Mounting Screw Befestigungsschraube	
AFM90-SE09-D040-A16-Z04-H	●	40	4	16	40	6.7	SEET 09T3..	3008-M3x8	80-T08	2506-M8x30	
AFM90-SE09-D050-A22-Z05-H	●	50	5	22	40	6.7				2508-M10x30	
AFM90-SE09-D063-A22-Z06-H	●	63	6	22	40	6.7				-	

ZCC Ucuna Uygunudur. / Compatible with ZCC Insert. Kompatibel mit ZCC Wendeplatten.

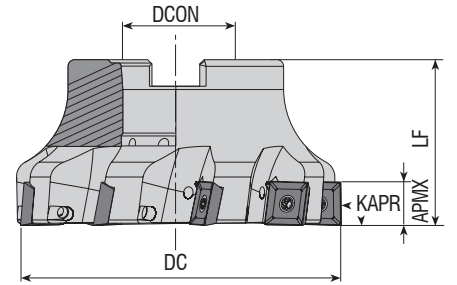

Takım Kodu Ordering Code Bestell-Bezeichnung	Stok Stock Lager	Takım Ölçüleri (mm) Dimension (mm) Abmessung (mm)					Kesici Uç Insert Wendeschneidplatte	Yedek Parçaları / Spare Parts / Ersatzteile			
		DC	ZEFP	DCON	LF	APMX		Sıkma Vidası Screw Schraube	Tork Anahtar Torx Key Torx-Schlüssel	Montaj Vidası Mounting Screw Befestigungsschraube	
AFM90-SE12-D050-A22-Z04-H	●	50	4	22	40	12	SEET 1203..	4015-M3.5x11	80-T15	2508-M10x30	
AFM90-SE12-D063-A22-Z05-H	●	63	5	22	40	12				2510-M12x35	
AFM90-SE12-D080-A27-Z07-H	●	80	7	27	50	12				2514-M16x35	
AFM90-SE12-D100-A32-Z09-H	●	100	9	32	50	12				-	
AFM90-SE12-D125-B40-Z11	●	125	11	40	63	12				-	

R: Sağ / Right / Rechts L: Sol/Left/Links

● Stokta / In Stock / Auf Lager ○ Stokta Yok / Non Stock Item / Kein Lagerartikel, Lieferzeit auf Anfrage  
ZCC Ucuna Uygunudur. / Compatible with ZCC Insert. Kompatibel mit ZCC Wendeplatten.

Sipariş Örneği/Ordering Example/Bestellbeispiel  
1 ad./pcs./stück AFM90-SE09-D040-A16-Z04-H



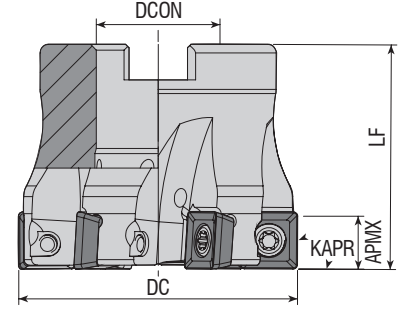

Takım Kodu Ordering Code Bestell-Bezeichnung	Stok Stock Lager	Takım Ölçüleri (mm) Dimension (mm) Abmessung (mm)					Kesici Uç Insert Wendeschneidplatte	Yedek Parçaları / Spare Parts / Ersatzteile		
		DC	ZEFP	DCON	LF	APMX		Sıkma Vidası Screw Schraube	Tork Anahtar Torx Key Torx-Schlüssel	Montaj Vidası Mounting Screw Befestigungsschraube
AFM90-SP1004-D040-A16-Z04-H	●	40	4	16	40	9.4	SPMT 1004.. XPMT 1004.. QPMR 1004.. QPMT 1004..	4015-M4x10	80-T15	2506-M8x30
AFM90-SP1004-D050-A22-Z04-H	●	50	4	22	40	9.4				2508-M10x30
AFM90-SP1004-D050-A22-Z06-H	●	50	6	22	40	9.4				2510-M12x35
AFM90-SP1004-D063-A22-Z05-H	●	63	5	22	40	9.4				2514-M16x35
AFM90-SP1004-D080-A27-Z07-H	●	80	7	27	50	9.4				
AFM90-SP1004-D100-A32-Z08-H	●	100	8	32	50	9.4				

ISCR Ucuna Uygundur. / Compatible with ISCR Insert. Kompatibel mit ISCR Wendeplatten.

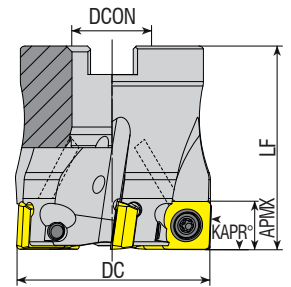

Takım Kodu Ordering Code Bestell-Bezeichnung	Stok Stock Lager	Takım Ölçüleri (mm) Dimension (mm) Abmessung (mm)					Kesici Uç Insert Wendeschneidplatte	Yedek Parçaları / Spare Parts / Ersatzteile		
		DC	ZEFP	DCON	LF	APMX		Sıkma Vidası Screw Schraube	Tork Anahtar Torx Key Torx-Schlüssel	Montaj Vidası Mounting Screw Befestigungsschraube
AFM90-SP09T3-D040-A16-Z05-H	●	40	5	16	40	8.6	SPMT 09T3..	3010-M3.5x9	80-T10	2506-M8x30
AFM90-SP09T3-D050-A22-Z06-H	●	50	6	22	40	8.6				2508-M10x30
AFM90-SP09T3-D063-A22-Z07-H	●	63	7	22	40	8.6				2510-M12x35
AFM90-SP09T3-D080-A27-Z08-H	●	80	8	27	50	8.6				

R: Sağ / Right / Rechts L: Sol/Left/Links

● Stokta / In Stock / Auf Lager ○ Stokta Yok / Non Stock Item / Kein Lagerartikel, Lieferzeit auf Anfrage  
SNDVK Ucuna Uygundur. / Compatible with SNDVK Insert. Kompatibel mit SNDVK Wendeplatten.

Sipariş Örneği/Ordering Example/Bestellbeispiel

1 ad./pcs./stück AFM90-SP1004-D040-A16-Z04-H

Kesme Hesabı : S 367 / Cutting Calculation : P 367 / Schnittberechnung : 367

Montaj Ölçüleri : S 364 / Mounting Reference : P 364 / Montagehinweis : 364

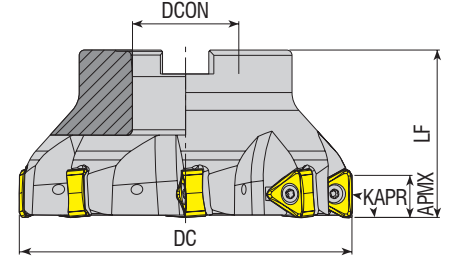

Takım Kodu Ordering Code Bestell-Bezeichnung	Stok Stock Lager	Takım Ölçüleri (mm) Dimension (mm) Abmessung (mm)					Kesici Uç Insert Wendeschneidplatte	Yedek Parçaları / Spare Parts / Ersatzteile		
		DC	ZEFP	DCON	LF	APMX		Sıkma Vidası Screw Schraube	Tork Anahtar Torx Key Torx-Schlüssel	Montaj Vidası Mounting Screw Befestigungsschraube
AFM90-TN2207-D063-A22-Z04-H	●	63	4	22	40	15	TN.X 2207..	1120-M4.5x12	80-T20	2508-M10x30
AFM90-TN2207-D080-A27-Z05-H	●	80	5	27	50	15				2510-M12x35
AFM90-TN2207-D100-B32-Z06	●	100	6	32	50	15				2514-M16x35
AFM90-TN2207-D125-B40-Z08	●	125	8	40	63	15				-

TGTC Ucuna Uyundur. / Compatible with TGTC Insert. Kompatibel mit TGTC Wendeplatten.

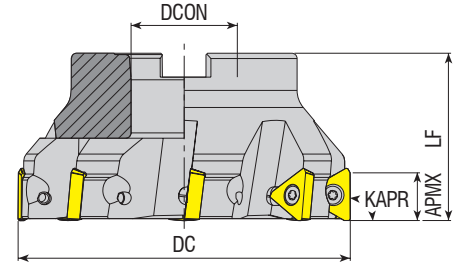

Takım Kodu Ordering Code Bestell-Bezeichnung	Stok Stock Lager	Takım Ölçüleri (mm) Dimension (mm) Abmessung (mm)					Kesici Uç Insert Wendeschneidplatte	Yedek Parçaları / Spare Parts / Ersatzteile		
		DC	ZEFP	DCON	LF	APMX		Sıkma Vidası Screw Schraube	Tork Anahtar Torx Key Torx-Schlüssel	Montaj Vidası Mounting Screw Befestigungsschraube
AFM90-TP2205-D063-A22-Z04	●	63	4	22	40	18	TPKT 2205..	1120-M4.5x12	80-T20	2508-M10x30
AFM90-TP2205-D080-A27-Z06	●	80	6	27	50	18				2510-M12x35
AFM90-TP2205-D100-A32-Z07	●	100	7	32	50	18				2514-M16x35
AFM90-TP2205-D125-B40-Z08	●	125	8	40	63	18				-
AFM90-TP2205-D160-C40-Z09	●	160	9	40	63	18				-
AFM90-TP2205-D200-C60-Z12	●	200	12	60	63	18				-

R: Sağ / Right / Rechts L: Sol/Left/Links

● Stokta / In Stock / Auf Lager ○ Stokta Yok / Non Stock Item / Kein Lagerartikel, Lieferzeit auf Anfrage  
TGTC Ucuna Uyundur. / Compatible with TGTC Insert. Kompatibel mit TGTC Wendeplatten.

Sipariş Örneği/Ordering Example/Bestellbeispiel

1 ad./pcs./stück AFM90-TN2207-D063-A22-Z04-H

Kesme Hesabı : S 367 / Cutting Calculation : P 367 / Schnittberechnung : 367

Montaj Ölçüleri : S 364 / Mounting Reference : P 364 / Montagehinweis : 364



KAPR=90°

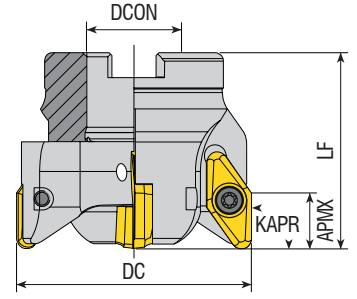

Takım Kodu Ordering Code Bestell-Bezeichnung	Stok Stock Lager	Takım Ölçüleri (mm) Dimension (mm) Abmessung (mm)					Kesici Uç Insert Wendeschneidplatte	Yedek Parçaları / Spare Parts / Ersatzteile			
		DC	ZEFP	DCON	LF	APMX		Sıkma Vidası Screw Schraube	Tork Anahtar Torx Key Torx-Schlüssel	Montaj Vidası Mounting Screw Befestigungsschraube	
AFM90-VC2205-D050-A22-Z03-H	●	50	3	22	55	15	VCKT 2205..				
AFM90-VC2205-D063-A22-Z04-H	●	63	4	22	55	15					
AFM90-VC2205-D066-A27-Z04-H	●	66	4	27	55	15					
AFM90-VC2205-D080-A27-Z05-H	●	80	5	27	60	15					

ISO Ucuna Uygun. / Compatible with ISO Insert. Kompatibel mit ISO Wendeplatten.



KAPR=90°

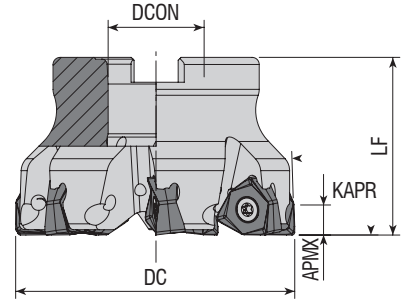

Takım Kodu Ordering Code Bestell-Bezeichnung	Stok Stock Lager	Takım Ölçüleri (mm) Dimension (mm) Abmessung (mm)					Kesici Uç Insert Wendeschneidplatte	Yedek Parçaları / Spare Parts / Ersatzteile			
		DC	ZEFP	DCON	LF	APMX		Sıkma Vidası Screw Schraube	Tork Anahtar Torx Key Torx-Schlüssel	Montaj Vidası Mounting Screw Befestigungsschraube	
AFM90-WNG04-D040-A16-Z06-H	●	40	6	16	40	4	WNGU 0403..				
AFM90-WNG04-D050-A22-Z05-H	●	50	5	22	40	4					
AFM90-WNG04-D050-A22-Z07-H	●	50	7	22	40	4					
AFM90-WNG04-D063-A22-Z06-H	●	63	6	22	40	4					
AFM90-WNG08-D050-A22-Z05-H	●	50	5	22	40	7.5	WNGU 0806..				
AFM90-WNG08-D063-A22-Z06-H	●	63	6	22	40	7.5					
AFM90-WNG08-D080-A27-Z07-H	●	80	7	27	50	7.5					

R: Sağ / Right / Rechts L: Sol/Left/Links

● Stokta / In Stock / Auf Lager ○ Stokta Yok / Non Stock Item / Kein Lagerartikel, Lieferzeit auf Anfrage

XTC-GSC Ucuna Uygun. / Compatible with XTC-GSC Insert. Kompatibel mit XTC-GSC Wendeplatten.

Sipariş Örneği/Ordering Example/Bestellbeispiel

1 ad./pcs./stück AFM90-VC2205-D050-A22-Z03-H

Kesme Hesabı : S 367 / Cutting Calculation : P 367 / Schnittberechnung : 367

Montaj Ölçüleri : S 364 / Mounting Reference : P 364 / Montagehinweis : 364

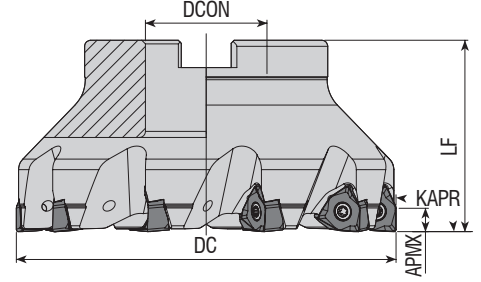

Takım Kodu Ordering Code Bestell-Bezeichnung	Stok Stock Lager	Takım Ölçüleri (mm) Dimension (mm) Abmessung (mm)					Kesici Uç Insert Wendeschneidplatte	Yedek Parçaları / Spare Parts / Ersatzteile		
		DC	ZEFP	DCON	LF	APMX		Sıkma Vidası Screw Schraube	Tork Anahtar Torx Key Torx-Schlüssel	Montaj Vidası Mounting Screw Befestigungsschraube
AFM90-WN0604Z-D040-A16-Z04-H	●	40	4	16	40	5.7	WNHU 0604..	3008-M3x8	80-T08	2506-M8x30
AFM90-WN0604Z-D050-A22-Z05-H	●	50	5	22	40	5.7				2508-M10x30
AFM90-WN0604Z-D063-A22-Z06-H	●	63	6	22	40	5.7				2510-M12x35
AFM90-WN0604Z-D080-A27-Z07-H	●	80	7	27	50	5.7				2514-M16x35
AFM90-WN0604Z-D100-A32-Z09-H	●	100	9	32	50	5.7				-
AFM90-WN0806Z-D050-A22-Z04-H	●	50	4	22	40	7.7	WNHU 0806..	4015-M4x11	80-T15	2508-M10x30
AFM90-WN0806Z-D063-A22-Z05-H	●	63	5	22	40	7.7				2510-M12x35
AFM90-WN0806Z-D080-A27-Z06-H	●	80	6	27	50	7.7				2514-M16x35
AFM90-WN0806Z-D100-A32-Z08-H	●	100	8	32	50	7.7				-
AFM90-WN0806Z-D125-B40-Z10	●	125	10	40	63	7.7				-
AFM90-WN0806Z-D160-C40-Z12	●	160	12	40	63	7.7	-	-	-	

ZCC Ucuna Uygundur. / Compatible with ZCC Insert. Kompatibel mit ZCC Wendepfatten.

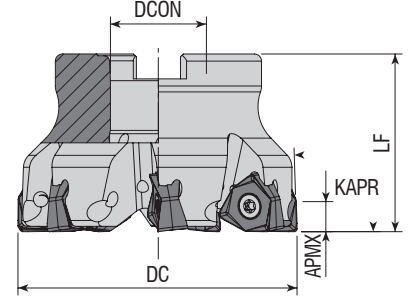

Takım Kodu Ordering Code Bestell-Bezeichnung	Stok Stock Lager	Takım Ölçüleri (mm) Dimension (mm) Abmessung (mm)					Kesici Uç Insert Wendeschneidplatte	Yedek Parçaları / Spare Parts / Ersatzteile		
		DC	ZEFP	DCON	LF	APMX		Sıkma Vidası Screw Schraube	Tork Anahtar Torx Key Torx-Schlüssel	Montaj Vidası Mounting Screw Befestigungsschraube
AFM90-WN0806Z-D050-A16-Z04-H	●	50	4	16	40	8	WNMX 080608	1615-M5x14	80-T15	2506-M8x30
AFM90-WN0806Z-D063-A22-Z05-H	●	63	5	22	40	8				2508-M10x30
AFM90-WN0806Z-D080-A27-Z07-H	●	80	7	27	50	8				2510-M12x35

R: Sağ / Right / Rechts L: Sol/Left/Links

● Stokta / In Stock / Auf Lager ○ Stokta Yok / Non Stock Item / Kein Lagerartikel, Lieferzeit auf Anfrage  
KYCR-JD Ucuna Uygundur. / Compatible with KYCR-JD Insert. Kompatibel mit KYCR-JD Wendepfatten.

Sipariş Örneği/Ordering Example/Bestellbeispiel

1 ad./pcs./stück AFM90-WN0604Z-D040-A16-Z04-H

Kesme Hesabı : S 367 / Cutting Calculation : P 367 / Schnittberechnung : 367

Montaj Ölçüleri : S 364 / Mounting Reference : P 364 / Montagehinweis : 364



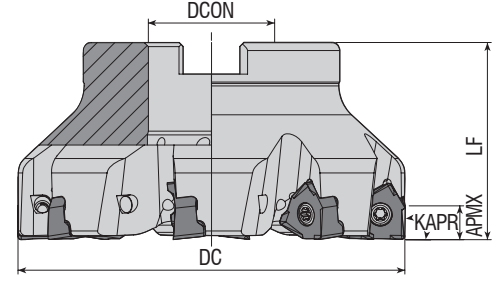

Takım Kodu Ordering Code Bestell-Bezeichnung	Stok Stock Lager	Takım Ölçüleri (mm) Dimension (mm) Abmessung (mm)					Kesici Uç Insert Wendeschneidplatte	Yedek Parçaları / Spare Parts / Ersatzteile					
		DC	ZEFP	DCON	LF	APMX		Sıkma Vidası Screw Schraube	Tork Anahtar Torx Key Torx-Schlüssel	Montaj Vidası Mounting Screw Befestigungsschraube			
AFM90-XN0403-D040-A16-Z05-H	●	40	5	16	40	4	XNEX 0403..	3008-M2.5x6	80-T08	2506-M8x30			
AFM90-XN0806-D050-A22-Z04-H	●	50	4	22	40	7.5				XNEX 0806..	4015-M4x11	80-T15	2508-M10x30
AFM90-XN0806-D063-A22-Z05-H	●	63	5	22	40	7.5							2510-M12x35
AFM90-XN0806-D080-A27-Z07-H	●	80	7	27	50	7.5							2514-M16x35
AFM90-XN0806-D100-A32-Z08-H	●	100	8	32	50	7.5							

SC Ucuna Uygunur. / Compatiple with SC Insert. Kompatibel mit SC Wendeplatten.

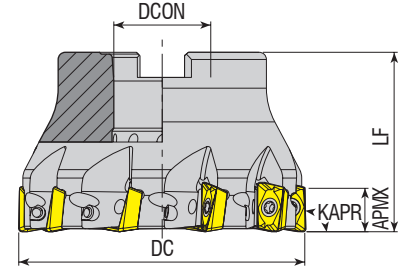

Takım Kodu Ordering Code Bestell-Bezeichnung	Stok Stock Lager	Takım Ölçüleri (mm) Dimension (mm) Abmessung (mm)					Kesici Uç Insert Wendeschneidplatte	Yedek Parçaları / Spare Parts / Ersatzteile			
		DC	ZEFP	DCON	LF	APMX		Sıkma Vidası Screw Schraube	Tork Anahtar Torx Key Torx-Schlüssel	Montaj Vidası Mounting Screw Befestigungsschraube	
AFM90-XO12-D040-A16-Z05-H	●	40	5	16	40	11	XO.. 1204..	3010-M3.5x9	80-T10	2506-M8x30	
AFM90-XO12-D050-A22-Z07-H	●	50	7	22	40	11				2508-M10x30	
AFM90-XO12-D063-A22-Z08-H	●	63	8	22	40	11				2510-M12x35	
AFM90-XO12-D080-A27-Z10-H	●	80	10	27	50	11				2514-M16x35	
AFM90-XO12-D100-A32-Z12-H	●	100	12	32	50	11					

R: Sağ / Right / Rechts L: Sol/Left/Links

● Stokta / In Stock / Auf Lager ○ Stokta Yok / Non Stock Item / Kein Lagerartikel, Lieferzeit auf Anfrage  
SC Ucuna Uygunur. / Compatiple with SC Insert. Kompatibel mit SC Wendeplatten.

Sipariş Örneği/Ordering Example/Bestellbeispiel  
1 ad./pcs./stück AFM90-XN0403-D040-A16-Z05-H  
Kesme Hesabı : S 367 / Cutting Calculation : P 367 / Schnittberechnung : 367  
Montaj Ölçüleri : S 364 / Mounting Reference : P 364 / Montagehinweis : 364

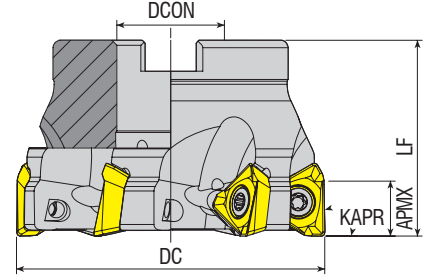

Takım Kodu Ordering Code Bestell-Bezeichnung	Stok Stock Lager	Takım Ölçüleri (mm) Dimension (mm) Abmessung (mm)					Kesici Uç Insert Wendeschneidplatte	Yedek Parçaları / Spare Parts / Ersatzteile		
		DC	ZEFP	DCON	LF	APMX		Sıkma Vidası Screw Schraube	Tork Anahtar Torx Key Torx-Schlüssel	Montaj Vidası Mounting Screw Befestigungsschraube
AFM90-3P1004-D040-A16-Z05-H	●	40	5	16	40	7	3PKT 1004..	1108-M2.5x6	80-T08	2506-M8x30
AFM90-3P1004-D050-A22-Z06-H	●	50	6	22	40	7				
AFM90-3P1505-D050-A22-Z04-H	●	50	4	22	40	11	3PKT 1505..	1115-M4x10	80-T15	2508-M10x30
AFM90-3P1505-D050-A22-Z05-H	●	50	5	22	40	11				
AFM90-3P1505-D063-A22-Z04-H	●	63	4	22	40	11				
AFM90-3P1505-D063-A22-Z06-H	●	63	6	22	40	11				
AFM90-3P1505-D080-A27-Z07-H	●	80	7	27	50	11				
AFM90-3P1505-D100-A32-Z08-H	●	100	8	32	50	11				
AFM90-3P1505-D125-B40-Z10	●	125	10	40	63	11	-	-	-	-

TGTC Ucuna Uygunur. / Compatiple with TGTC Insert. Kompatibel mit TGTC Wendeplatten.

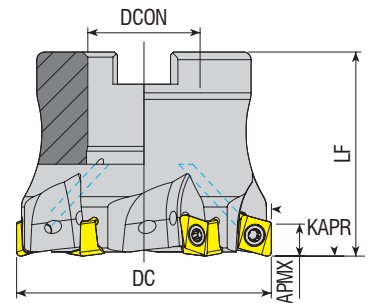

Takım Kodu Ordering Code Bestell-Bezeichnung	Stok Stock Lager	Takım Ölçüleri (mm) Dimension (mm) Abmessung (mm)					Kesici Uç Insert Wendeschneidplatte	Yedek Parçaları / Spare Parts / Ersatzteile		
		DC	ZEFP	DCON	LF	APMX		Sıkma Vidası Screw Schraube	Tork Anahtar Torx Key Torx-Schlüssel	Montaj Vidası Mounting Screw Befestigungsschraube
AFM90-4N06-D040-A16-Z05-H	●	40	5	16	40	6	4NKT 0603..	1108-M3x6.8	80-T08	2506-M8x30
AFM90-4N06-D050-A22-Z06-H	●	50	6	22	40	6				2508-M10x30

R: Sağ / Right / Rechts L: Sol/Left/Links

● Stokta / In Stock / Auf Lager ○ Stokta Yok / Non Stock Item / Kein Lagerartikel, Lieferzeit auf Anfrage

TGTC Ucuna Uygunur. / Compatiple with TGTC Insert. Kompatibel mit TGTC Wendeplatten.

Sipariş Örneği/Ordering Example/Bestellbeispiel

1 ad./pcs./stück AFM90-3P1004-D040-A16-Z05-H

Kesme Hesabı : S 367 / Cutting Calculation : P 367 / Schnittberechnung : 367

Montaj Ölçüleri : S 364 / Mounting Reference : P 364 / Montagehinweis : 364

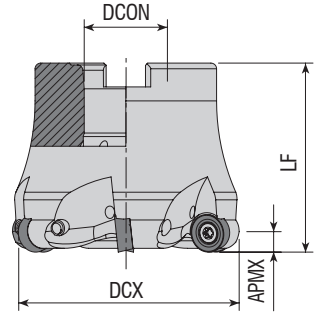

Takım Kodu Ordering Code Bestell-Bezeichnung	Stok Stock Lager	Takım Ölçüleri (mm) Dimension (mm) Abmessung (mm)					Kesici Uç Insert Wendeschneidplatte	Yedek Parçaları / Spare Parts / Ersatzteile			
		DCX	ZEFP	DCON	LF	APMX		Sıkma Vidası Screw Schraube	Tork Anahtar Torx Key Torx-Schlüssel	Montaj Vidası Mounting Screw Befestigungsschraube	
AFMR-RC10T3-D040-A16-Z04-H	●	40	4	16	40	5	RC.. 10T3..	4015-M4x11	80-T15	2406-M8x30	
AFMR-RC10T3-D050-A22-Z05-H	●	50	5	22	50	5				2508-M10x30	
AFMR-RC10T3-D063-A22-Z06-H	●	63	6	22	50	5					

ZCC Ucuna Uygun. / Compatible with ZCC Insert. Kompatibel mit ZCC Wendeplatten.

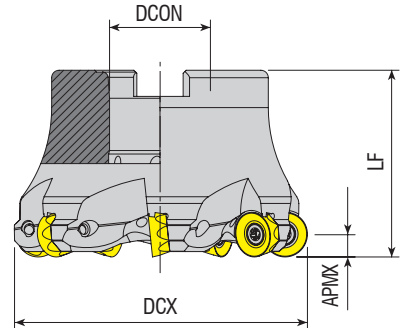

Takım Kodu Ordering Code Bestell-Bezeichnung	Stok Stock Lager	Takım Ölçüleri (mm) Dimension (mm) Abmessung (mm)					Kesici Uç Insert Wendeschneidplatte	Yedek Parçaları / Spare Parts / Ersatzteile			
		DCX	ZEFP	DCON	LF	APMX		Sıkma Vidası Screw Schraube	Tork Anahtar Torx Key Torx-Schlüssel	Montaj Vidası Mounting Screw Befestigungsschraube	
AFMR-RC1204-D040-A16-Z04-H	●	40	4	16	40	6	RC.. 1204..	4015-M3.5x11	80-T15	2506-M8x30	
AFMR-RC1204-D050-A22-Z05-H	●	50	5	22	50	6				2508-M10x30	
AFMR-RC1204-D052-A22-Z05-H	●	52	5	22	50	6					
AFMR-RC1204-D063-A22-Z06-H	●	63	6	22	50	6					
AFMR-RC1204-D063-A27-Z06-H	●	80	6	27	50	6					
AFMR-RC1204-D080-A27-Z07-H	●	80	7	27	50	6					2510-M12x35

R: Sağ / Right / Rechts L: Sol/Left/Links

● Stokta / In Stock / Auf Lager ○ Stokta Yok / Non Stock Item / Kein Lagerartikel, Lieferzeit auf Anfrage  
SNDVK Ucuna Uygun. / Compatible with SNDVK Insert. Kompatibel mit SNDVK Wendeplatten.

Sipariş Örneği/Ordering Example/Bestellbeispiel  
1 ad./pcs./stück AFMR-RC10T3-D040-A16-Z04-H

Kesme Hesabı : S 367 / Cutting Calculation : P 367 / Schnittberechnung : 367  
Montaj Ölçüleri : S 364 / Mounting Reference : P 364 / Montagehinweis : 364

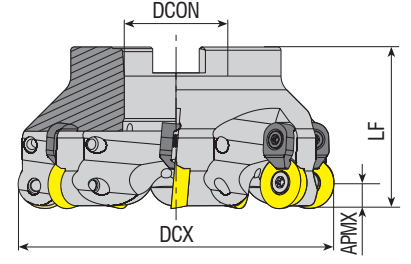

Takım Kodu Ordering Code Bestell-Bezeichnung	Stok Stock Lager	Takım Ölçüleri (mm) Dimension (mm) Abmessung (mm)					Kesici Uç Insert Wendeschneidplatte	Yedek Parçaları / Spare Parts / Ersatzteile				
		DCX	ZEFP	DCON	LF	APMX		Sıkma Vidası Screw Schraube	Baskı Parçası Wedge Clamp Spannpratze	Baskı Vidası Clamp Screw Klemmschraube	Tork Anahtar Torx Key Torx-Schlüssel	Montaj Vidası Mounting Screw Befestigungsschraube
AFMR-RD0702-D050-A22-Z06-H	●	50	6	22	40	3.5	RD.. 0702..	3008-M2.5x6	-	-	80-T08	2407-M10x30
AFMR-RD0803-D050-A22-Z05-H	●	50	5	22	40	4	RD.. 0803..	3008-M3x8	-	-	80-T08	2407-M10x30
AFMRC-RD1003-D040-A16-Z04-H	●	40	4	16	40	5	RD.. 1003..				2406-M8x30	
AFMRC-RD1003-D050-A22-Z05-H	●	50	5	22	50	5					2508-M10x30	
AFMRC-RD1003-D052-A22-Z05	●	52	5	22	50	5					2510-M12x35	
AFMRC-RD1003-D063-A22-Z06-H	●	63	6	22	50	5					2514-M16x35	
AFMRC-RD1003-D080-A27-Z07-H	●	80	7	27	50	5					2508-M10x30	
AFMRC-RD1003-D100-A32-Z08-H	●	100	8	32	50	5					2406-M8x30	
AFMRC-RD10T3-D050-A22-Z05-H	●	50	5	22	50	5					RD.. 10T3..	4015-M3.5x11
AFMRC-RD10T3-D063-A22-Z06-H	●	63	6	22	50	5	RD.. 10T3..	4015-M3.5x11	ACK-15	4015-M3.5x11	80-T15	2510-M12x35
AFMRC-RD12T3-D040-A16-Z04-H	●	40	4	16	40	6	RD.. 12T3..	4015-M3.5x11	ACK-15	4015-M3.5x11	80-T15	2514-M16x35
AFMRC-RD12T3-D050-A22-Z05-H	●	50	5	22	50	6						-
AFMRC-RD12T3-D052-A22-Z05-H	●	52	5	22	50	6						-
AFMRC-RD12T3-D063-A22-Z06-H	●	63	6	22	50	6						-
AFMRC-RD12T3-D080-A27-Z07-H	●	80	7	27	50	6						-
AFMRC-RD12T3-D100-A32-Z08-H	●	100	8	32	50	6						-
AFMRC-RD12T3-D125-B40-Z09	●	125	9	40	63	6						-
AFMRC-RD1204-D040-A16-Z04-H	●	40	4	16	40	6	RD.. 1204..				2406-M8x30	
AFMRC-RD1204-D050-A22-Z05-H	●	50	5	22	50	6					2508-M10x30	
AFMRC-RD1204-D052-A22-Z05-H	●	52	5	22	50	6					2510-M12x35	
AFMRC-RD1204-D063-A22-Z06-H	●	63	6	22	50	6					2514-M16x35	
AFMRC-RD1204-D080-A27-Z07-H	●	80	7	27	50	6					-	
AFMRC-RD1204-D100-A32-Z07-H	●	100	7	32	50	6					-	
AFMRC-RD1204-D100-A32-Z08-H	●	100	8	32	50	6					-	
AFMRC-RD1604-D050-A22-Z04-H	●	50	4	22	50	8	RD.. 1604..	4015-M4.5x11	ACK-05	4015-M4x11	2408-M10x30	
AFMRC-RD1604-D052-A22-Z04-H	●	52	4	22	50	8					2508-M10x30	
AFMRC-RD1604-D063-A22-Z05-H	●	63	5	22	50	8					2510-M12x35	
AFMRC-RD1604-D066-A22-Z05-H	●	66	5	22	50	8					2514-M16x35	
AFMRC-RD1604-D066-A27-Z05-H	●	66	5	27	50	8					-	
AFMRC-RD1604-D080-A27-Z06-H	●	80	6	27	50	8					-	
AFMRC-RD1604-D100-A32-Z07-H	●	100	7	32	50	8					-	
AFMRC-RD1604-D125-B40-Z07	●	125	7	40	63	8	-					
AFMRC-RD1604-D160-C40-Z08	●	160	8	40	63	8	-					

R: Sağ / Right / Rechts L: Sol/Left/Links

● Stokta / In Stock / Auf Lager ○ Stokta Yok / Non Stock Item / Kein Lagerartikel, Lieferzeit auf Anfrage  
ISO Ucuna Uygun. / Compatible with ISO Insert. Kompatibel mit ISO Wendepplatten.

Sipariş Örneği/Ordering Example/Bestellbeispiel

1 ad./pcs./stück AFMR-RD0702-D050-A22-Z06-H

Kesme Hesabı : S 367 / Cutting Calculation : P 367 / Schnittberechnung : 367

Montaj Ölçüleri : S 364 / Mounting Reference : P 364 / Montagehinweis : 364



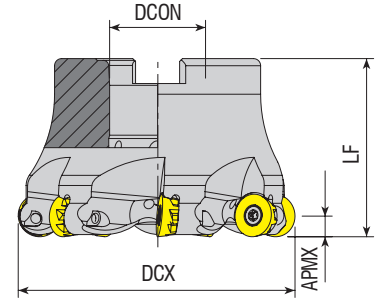

Takım Kodu Ordering Code Bestell-Bezeichnung	Stok Stock Lager	Takım Ölçüleri (mm) Dimension (mm) Abmessung (mm)					Kesici Uç Insert Wendeschneidplatte	Yedek Parçaları / Spare Parts / Ersatzteile		
		DCX	ZEFP	DCON	LF	APMX		Sıkma Vidası Screw Schraube	Tork Anahtar Torx Key Torx-Schlüssel	Montaj Vidası Mounting Screw Befestigungsschraube
AFMR-RP10T3-D063-A22-Z06-H	●	63	6	22	40	5	RPNX 10T3..	4010-M3x8	80-T10	2508-M10x30
AFMR-RP10T3-D080-A27-Z07-H	●	80	7	27	50	5				2510-M12x35
AFMR-RP1204-D040-A16-Z04-H	●	40	4	16	40	6	RPNX 1204..	4015-M3.5x11	80-T15	2406-M8x30
AFMR-RP1204-D080-A27-Z07-H	●	80	7	27	50	6				2510-M12x35

CRTZT Ucuna Uygunudur. / Compatible with CRTZT Insert. Kompatibel mit CRTZT Wendeplatten.

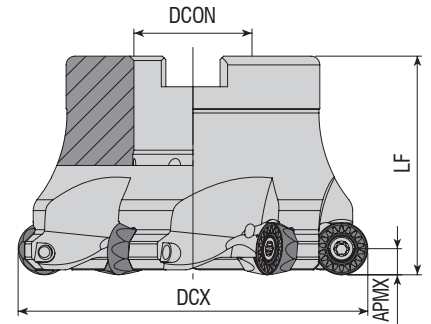

Takım Kodu Ordering Code Bestell-Bezeichnung	Stok Stock Lager	Takım Ölçüleri (mm) Dimension (mm) Abmessung (mm)					Kesici Uç Insert Wendeschneidplatte	Yedek Parçaları / Spare Parts / Ersatzteile		
		DCX	ZEFP	DCON	LF	APMX		Sıkma Vidası Screw Schraube	Tork Anahtar Torx Key Torx-Schlüssel	Montaj Vidası Mounting Screw Befestigungsschraube
AFMR-RP1204M-D050-A22-Z04-H	●	50	4	22	50	6	RPMT 1204..	4015-M4x11	80-T15	2508-M10x30
AFMR-RP1204M-D052-A22-Z05-H	●	52	5	22	50	6				2510-M12x35
AFMR-RP1204M-D063-A22-Z05-H	●	63	5	22	50	6				
AFMR-RP1204M-D080-A27-Z06-H	●	80	6	27	50	6				

R: Sağ / Right / Rechts L: Sol/Left/Links

● Stokta / In Stock / Auf Lager ○ Stokta Yok / Non Stock Item / Kein Lagerartikel, Lieferzeit auf Anfrage  
MTSBH Ucuna Uygunudur. / Compatible with MTSBH Insert. Kompatibel mit MTSBH Wendeplatten.

Sipariş Örneği/Ordering Example/Bestellbeispiel  
1 ad./pcs./stück AFMR-RP10T3-D063-A22-Z06-H

Kesme Hesabı : S 367 / Cutting Calculation : P 367 / Schnittberechnung : 367  
Montaj Ölçüleri : S 364 / Mounting Reference : P 364 / Montagehinweis : 364

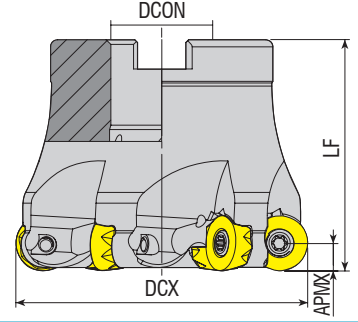

Takım Kodu Ordering Code Bestell-Bezeichnung	Stok Stock Lager	Takım Ölçüleri (mm) Dimension (mm) Abmessung (mm)					Kesici Uç Insert Wendeschneidplatte	Yedek Parçaları / Spare Parts / Ersatzteile		
		DCX	ZEFP	DCON	LF	APMX		Sıkma Vidası Screw Schraube	Tork Anahtar Torx Key Torx-Schlüssel	Montaj Vidası Mounting Screw Befestigungsschraube
AFMR-RY10-D040-A16-Z04-H	●	40	4	16	40	5	RYMX 1004..	4015-M3.5x11	80-T15	2406-M8x30
AFMR-RY10-D040-A16-Z05-H	●	40	5	16	40	5				2506-M8x30
AFMR-RY10-D050-A22-Z05-H	●	50	5	22	50	5				2508-M10x30
AFMR-RY10-D063-A22-Z06-H	●	63	6	22	50	5				2406-M8x30
AFMR-RY12-D040-A16-Z04-H	●	40	4	16	40	6	RYMX 1205..	4015-M4x11	80-T15	2406-M8x30
AFMR-RY12-D050-A22-Z05-H	●	50	5	22	50	6				2508-M10x30
AFMR-RY12-D052-A22-Z05-H	●	52	5	22	50	6				2510-M12x35
AFMR-RY12-D063-A22-Z06-H	●	63	6	22	50	6				2514-M16x35
AFMR-RY12-D080-A27-Z06-H	●	80	6	27	50	6				
AFMR-RY12-D100-A32-Z07-H	●	100	7	32	50	6				

TGTC Ucuna Uygun. / Compatible with TGTC Insert. Kompatibel mit TGTC Wendeplatten.

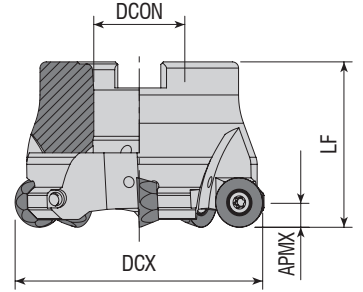

Takım Kodu Ordering Code Bestell-Bezeichnung	Stok Stock Lager	Takım Ölçüleri (mm) Dimension (mm) Abmessung (mm)					Kesici Uç Insert Wendeschneidplatte	Yedek Parçaları / Spare Parts / Ersatzteile		
		DCX	ZEFP	DCON	LF	APMX		Sıkma Vidası Screw Schraube	Tork Anahtar Torx Key Torx-Schlüssel	Montaj Vidası Mounting Screw Befestigungsschraube
AFMR-QP10T3-D040-A16-Z04-H	●	40	4	16	40	5	QP. 10T3..	4015-M3.5x11	80-T15	2506-M8x30
AFMR-QP10T3-D050-A22-Z05-H	●	50	5	22	40	5				2407-M10x30
AFMR-QP10T3-D063-A22-Z06-H	●	63	6	22	40	5				
AFMR-QP1204-D050-A22-Z04-H	●	50	4	22	40	6	QP. 1204..	4015-M4x11		
AFMR-QP1204-D063-A22-Z05-H	●	63	5	22	40	6				

R: Sağ / Right / Rechts L: Sol/Left/Links

● Stokta / In Stock / Auf Lager ○ Stokta Yok / Non Stock Item / Kein Lagerartikel, Lieferzeit auf Anfrage  
SMTM Ucuna Uygun. / Compatible with SMTM Insert. Kompatibel mit SMTM Wendeplatten.

Sipariş Örneği/Ordering Example/Bestellbeispiel

1 ad./pcs./stück AFMR-RY10-D040-A16-Z04-H

Kesme Hesabı : S 367 / Cutting Calculation : P 367 / Schnittberechnung : 367

Montaj Ölçüleri : S 364 / Mounting Reference : P 364 / Montagehinweis : 364

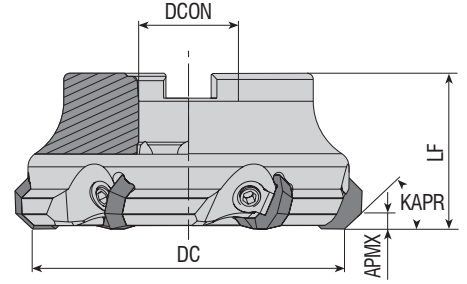

Takım Kodu Ordering Code Bestell-Bezeichnung	Stok Stock Lager	Takım Ölçüleri (mm) Dimension (mm) Abmessung (mm)					Kesici Uç Insert Wendeschneidplatte	Yedek Parçaları / Spare Parts / Ersatzteile				
		DC	ZEFP	DCON	LF	APMX		Baskı Parçası Wedge Clamp Spannpratze	Baskı Vidası Clamp Screw Klemmschraube	Anahtar Allen Key Innensechskantschlüssel	Montaj Vidası Mounting Screw Befestigungsschraube	
AFM43C-OF07-D063-A22-Z04	●	63	4	22	45	5	OF.. 0704..	ACK-11	AKV-15-M8x1x20	AAL-05-4		2508-M10x30
AFM43C-OF07-D080-A27-Z05	●	80	5	27	50	5						2510-M12x35
AFM43C-OF07-D100-A32-Z06	●	100	6	32	50	5						2514-M16x35
AFM43C-OF07-D125-B40-Z08	●	125	8	40	63	5						-
AFM43C-OF07-D160-C40-Z09	●	160	9	40	63	5						-

ISO Ucuna Uygunur. / Compatible with ISO Insert. Kompatibel mit ISO Wendeplatten.

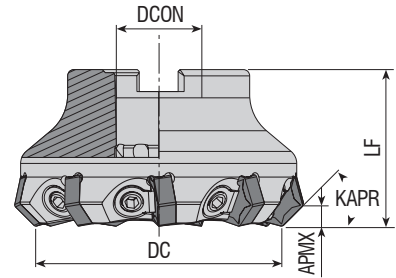

Takım Kodu Ordering Code Bestell-Bezeichnung	Stok Stock Lager	Takım Ölçüleri (mm) Dimension (mm) Abmessung (mm)					Kesici Uç Insert Wendeschneidplatte	Yedek Parçaları / Spare Parts / Ersatzteile				
		DC	ZEFP	DCON	LF	APMX		Baskı Parçası Wedge Clamp Spannpratze	Baskı Vidası Clamp Screw Klemmschraube	Anahtar Allen Key Innensechskantschlüssel	Montaj Vidası Mounting Screw Befestigungsschraube	
AFM45C-HN0905-D063-A22-Z07	●	63	7	22	40	4.5	HN.. 0905..	ACK-11	AKV-15-M8x1x20	AAL-05-4		2508-M10x30
AFM45C-HN0905-D080-A27-Z09	●	80	9	27	50	4.5						2510-M12x35
AFM45C-HN0905-D100-A32-Z11	●	100	11	32	50	4.5						2514-M16x35
AFM45C-HN0905-D125-B40-Z13	●	125	13	40	63	4.5						-
AFM45CL-HN0905-D125-B40-Z10	●	125	10	40	63	4.5						-
AFM45C-HN0905-D160-C40-Z15	●	160	15	40	63	4.5	-					

R: Sağ / Right / Rechts L: Sol/Left/Links

● Stokta / In Stock / Auf Lager ○ Stokta Yok / Non Stock Item / Kein Lagerartikel, Lieferzeit auf Anfrage

WDA-KNMTL Ucuna Uygunur. / Compatible with WDA-KNMTL Insert. Kompatibel mit WDA-KNMTL Wendeplatten.

Sipariş Örneği/Ordering Example/Bestellbeispiel

1 ad./pcs./stück AFM43C-OF07-D063-A22-Z04

Kesme Hesabı : S 367 / Cutting Calculation : P 367 / Schnittberechnung : 367

Montaj Ölçüleri : S 364 / Mounting Reference : P 364 / Montagehinweis : 364

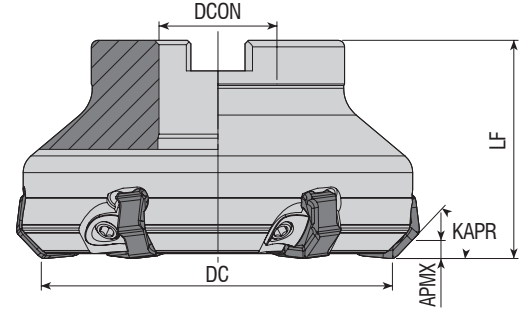

Takım Kodu Ordering Code Bestell-Bezeichnung	Stok Stock Lager	Takım Ölçüleri (mm) Dimension (mm) Abmessung (mm)					Kesici Uç Insert Wendeschneidplatte	Yedek Parçaları / Spare Parts / Ersatzteile				
		DC	ZEFP	DCON	LF	APMX		Baskı Parçası Wedge Clamp Spannpratze	Baskı Vidası Clamp Screw Klemmschraube	Anahtar Allen Key Innensechskantschlüssel	Montaj Vidası Mounting Screw Befestigungsschraube	
AFM45C-XN0806-D063-A22-Z05	●	63	5	22	50	4.5	XNMU 0806..	ACK-26	AKV-26-M6x0.75x20	AAL-03-03	2508-M10x30	
AFM45C-XN0806-D080-A27-Z06	●	80	6	27	50	4.5					2510-M12x35	
AFM45C-XN0806-D100-A32-Z08	●	100	8	32	50	4.5					2514-M16x35	
AFM45C-XN0806-D125-B40-Z08	●	125	8	40	63	4.5					-	
AFM45C-XN0806-D160-C40-Z10	●	160	10	40	63	4.5					-	
AFM45C-XN0806-D200-C60-Z12	●	200	12	60	63	4.5					-	

DJT Ucuna Uygun. / Compatible with DJT Insert. Kompatibel mit DJT Wendepfatten.

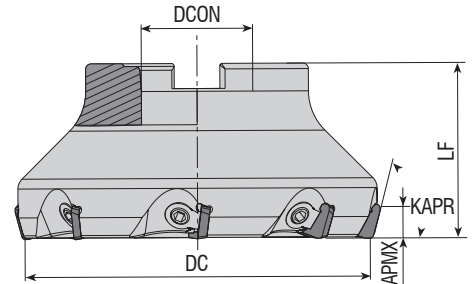

Takım Kodu Ordering Code Bestell-Bezeichnung	Stok Stock Lager	Takım Ölçüleri (mm) Dimension (mm) Abmessung (mm)					Kesici Uç Insert Wendeschneidplatte	Yedek Parçaları / Spare Parts / Ersatzteile				
		DC	ZEFP	DCON	LF	APMX		Baskı Parçası Wedge Clamp Spannpratze	Baskı Vidası Clamp Screw Klemmschraube	Anahtar Allen Key Innensechskantschlüssel	Montaj Vidası Mounting Screw Befestigungsschraube	
AFM75C-SP12-D050-A22-Z04	●	50	4	22	42	8	SPKN 1203..	ACK-10	AKV-22-M8x1x14	AAL-05-4	2508-M10x30	
AFM75C-SP12-D063-A22-Z05	●	63	5	22	40	8					2510-M12x35	
AFM75C-SP12-D080-A27-Z06	●	80	6	27	50	8					2514-M16x35	
AFM75C-SP12-D100-A32-Z07	●	100	7	32	50	8					-	
AFM75C-SP12-D125-B40-Z08	●	125	8	40	63	8					-	
AFM75C-SP12-D160-C40-Z09	●	160	9	40	63	8					-	
AFM75C-SP12-D200-C60-Z12	●	200	12	60	63	8	-					

R: Sağ / Right / Rechts L: Sol/Left/Links

● Stokta / In Stock / Auf Lager ○ Stokta Yok / Non Stock Item / Kein Lagerartikel, Lieferzeit auf Anfrage  
ISO Ucuna Uygun. / Compatible with ISO Insert. Kompatibel mit ISO Wendepfatten.

Sipariş Örneği/Ordering Example/Bestellbeispiel

1 ad./pcs./stück AFM45C-XN0806-D063-A22-Z05

Kesme Hesabı : S 367 / Cutting Calculation : P 367 / Schnittberechnung : 367

Montaj Ölçüleri : S 364 / Mounting Reference : P 364 / Montagehinweis : 364



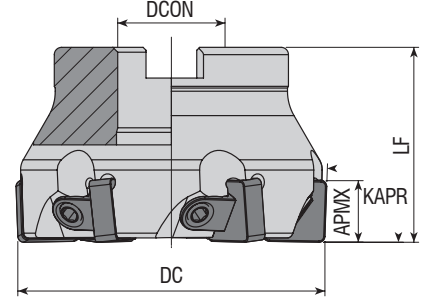

Takım Kodu Ordering Code Bestell-Bezeichnung	Stok Stock Lager	Takım Ölçüleri (mm) Dimension (mm) Abmessung (mm)					Kesici Uç Insert Wendeschneidplatte	Yedek Parçaları / Spare Parts / Ersatzteile			
		DC	ZEFP	DCON	LF	APMX		Baskı Parçası Wedge Clamp Spannpratze	Baskı Vidası Clamp Screw Klemmschraube	Anahtar Allen Key Innensechskantschlüssel	Montaj Vidası Mounting Screw Befestigungsschraube
AFM88C-SN1204-D050-A22-Z05	●	50	5	22	40	11	SN.. 1204..	ACK-21	AKV-24-M6x1x1	AAL-03-3	2408-M10x30
AFM88C-SN1204-D063-A22-Z06	●	63	6	22	40	11					2510-M12x35
AFM88C-SN1204-D080-A27-Z07	●	80	7	27	50	11					2514-M16x35
AFM88C-SN1204-D100-A32-Z08	●	100	8	32	50	11					-
AFM88C-SN1204-D125-B40-Z11	●	125	11	40	63	11					-

UNIN-NT.-KYCR Ucuna Uygunur. / Compatible with UNIN-NT.-KYCR Insert. Kompatibel mit UNIN-NT.-KYCR Wendeplatten.

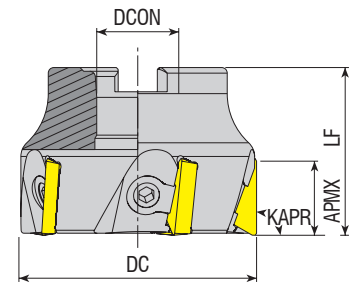

Takım Kodu Ordering Code Bestell-Bezeichnung	Stok Stock Lager	Takım Ölçüleri (mm) Dimension (mm) Abmessung (mm)					Kesici Uç Insert Wendeschneidplatte	Yedek Parçaları / Spare Parts / Ersatzteile			
		DC	ZEFP	DCON	LF	APMX		Baskı Parçası Wedge Clamp Spannpratze	Baskı Vidası Clamp Screw Klemmschraube	Anahtar Allen Key Innensechskantschlüssel	Montaj Vidası Mounting Screw Befestigungsschraube
AFM90C-TP16-D050-A22-Z04	●	50	4	22	40	12	TP. 1603..	ACK-10	AKV-22-M8x1x14 AKV-13-M8x1x16	AAL-05-4	2407-M10x30
AFM90C-TP16-D063-A22-Z06	●	63	6	22	45	12					2508-M10x30
AFM90C-TP16-D080-A27-Z07	●	80	7	27	50	12					2510-M12x35
AFM90C-TP16-D100-A32-Z08	●	100	8	32	50	12					2514-M16x35
AFM90C-TP16-D125-B40-Z08	●	125	8	40	63	12					-
AFM90C-TP22-D063-A22-Z05	●	63	5	22	45	18	TP. 2204..	ACK-11	AKV-14-M8x1x18	AAL-05-4	2508-M10x30
AFM90C-TP22-D080-A27-Z06	●	80	6	27	50	18					2510-M12x35
AFM90C-TP22-D100-A32-Z07	●	100	7	32	50	18					2514-M16x35
AFM90C-TP22-D125-B40-Z08	●	125	8	40	63	18					-
AFM90C-TP22-D160-C40-Z09	●	160	9	40	63	18					-
AFM90C-TP22-D200-C60-Z12	●	200	12	60	63	18					-
AFM90C-TP22-D250-C60-Z15	●	250	15	60	63	18					-
AFM90C-TP22-D315-D60-Z18	●	315	18	60	63	18					-

R: Sağ / Right / Rechts L: Sol/Left/Links  
● Stokta / In Stock / Auf Lager ○ Stokta Yok / Non Stock Item / Kein Lagerartikel, Lieferzeit auf Anfrage  
ISO Ucuna Uygunur. / Compatible with ISO Insert. Kompatibel mit ISO Wendeplatten.

Sipariş Örneği/Ordering Example/Bestellbeispiel  
1 ad./pcs./stück AFM88C-SN1204-D050-A22-Z05  
Kesme Hesabı : S 367 / Cutting Calculation : P 367 / Schnittberechnung : 367  
Montaj Ölçüleri : S 364 / Mounting Reference : P 364 / Montagehinweis : 364

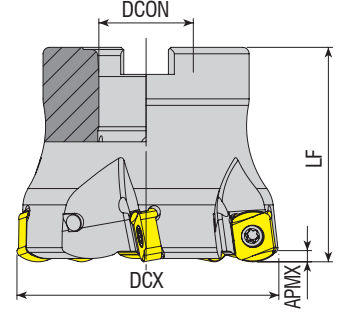

Takım Kodu Ordering Code Bestell-Bezeichnung	Stok Stock Lager	Takım Ölçüleri (mm) Dimension (mm) Abmessung (mm)					Kesici Uç Insert Wendeschneidplatte	Yedek Parçaları / Spare Parts / Ersatzteile		
		DCX	ZEFP	DCON	LF	APMX		Sıkma Vidası Screw Schraube	Tork Anahtar Torx Key Torx-Schlüssel	Montaj Vidası Mounting Screw Befestigungsschraube
AHFM-BL0603-D040-A16-Z06-H	●	40	6	16	40	1	BLMP 0603..	3008-M2.5x6	80-T08	2506-M8x30
AHFM-BL0603-D050-A22-Z07-H	●	50	7	22	40	1				
AHFM-BL0904-D040-A16-Z05-H	●	40	5	16	40	2	BLMP 0904..	3010-M3.5x9	80-T10	2508-M10x30
AHFM-BL0904-D050-A22-Z06-H	●	50	6	22	50	2				
AHFM-BL0904-D063-A22-Z05-H	●	63	5	22	50	2				
AHFM-BL0904-D063-A22-Z07-H	●	63	7	22	50	2				

TGTC Ucuna Uygunur. / Compatible with TGTC Insert. Kompatibel mit TGTC Wendeplatten.

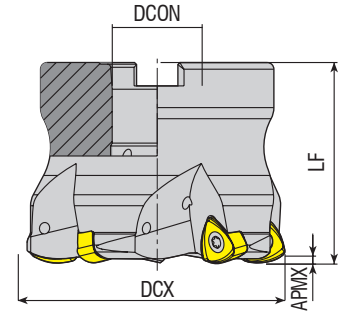

Takım Kodu Ordering Code Bestell-Bezeichnung	Stok Stock Lager	Takım Ölçüleri (mm) Dimension (mm) Abmessung (mm)					Kesici Uç Insert Wendeschneidplatte	Yedek Parçaları / Spare Parts / Ersatzteile		
		DCX	ZEFP	DCON	LF	APMX		Sıkma Vidası Screw Schraube	Tork Anahtar Torx Key Torx-Schlüssel	Montaj Vidası Mounting Screw Befestigungsschraube
AHFM-BL1205-D050-A22-Z03-H	●	50	3	22	40	2	BLMP 1205..	4015-M4x11	80-T15	2508-M10x30
AHFM-BL1205-D063-A22-Z04-H	●	63	4	22	40	2				
AHFM-BL1205-D080-A27-Z05-H	●	80	5	27	50	2				2510-M12x35

R: Sağ / Right / Rechts L: Sol/Left/Links

● Stokta / In Stock / Auf Lager ○ Stokta Yok / Non Stock Item / Kein Lagerartikel, Lieferzeit auf Anfrage  
TGTC Ucuna Uygunur. / Compatible with TGTC Insert. Kompatibel mit TGTC Wendeplatten.





Sipariş Örneği/Ordering Example/Bestellbeispiel

1 ad./pcs./stück AHFM-BL0603-D040-A16-Z06-H

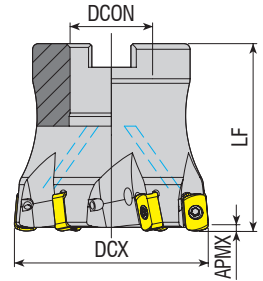
Kesme Hesabı : S 367 / Cutting Calculation : P 367 / Schnittberechnung : 367





Montaj Ölçüleri : S 364 / Mounting Reference : P 364 / Montagehinweis : 364

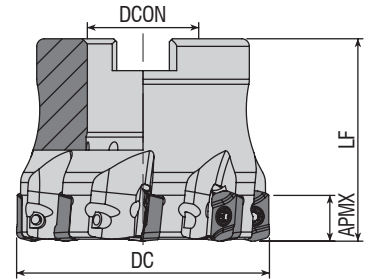

Takım Kodu Ordering Code Bestell-Bezeichnung	Stok Stock Lager	Takım Ölçüleri (mm) Dimension (mm) Abmessung (mm)					Kesici Uç Insert Wendeschneidplatte	Yedek Parçaları / Spare Parts / Ersatzteile		
		DCX	ZEFP	DCON	LF	APMX		Sıkma Vidası Screw Schraube	Tork Anahtar Torx Key Torx-Schlüssel	Montaj Vidası Mounting Screw Befestigungsschraube
AHFM-EN1004-D050-A22-Z05-H	●	50	5	22	50	1				
AHFM-EN1004-D050-A22-Z06-H	●	50	6	22	50	1				
AHFM-EN1004-D052-A22-Z06-H	●	52	6	22	50	1				
AHFM-EN1004-D063-A22-Z06-H	●	63	6	22	50	1				

DJT Ucuna Uygunur. / Compatible with DJT Insert. Kompatibel mit DJT Wendepplatten.



Takım Kodu Ordering Code Bestell-Bezeichnung	Stok Stock Lager	Takım Ölçüleri (mm) Dimension (mm) Abmessung (mm)					Kesici Uç Insert Wendeschneidplatte	Yedek Parçaları / Spare Parts / Ersatzteile		
		DC	ZEFP	DCON	LF	APMX		Sıkma Vidası Screw Schraube	Tork Anahtar Torx Key Torx-Schlüssel	Montaj Vidası Mounting Screw Befestigungsschraube
AHFM-EP1003-D050-A22-Z08-H	●	50	8	22	40	1				
AHFM-EP1003-D063-A22-Z08-H	●	63	8	22	40	1				

R: Sağ / Right / Rechts L: Sol/Left/Links

● Stokta / In Stock / Auf Lager ○ Stokta Yok / Non Stock Item / Kein Lagerartikel, Lieferzeit auf Anfrage  
DJT Ucuna Uygunur. / Compatible with DJT Insert. Kompatibel mit DJT Wendepplatten.

Sipariş Örneği/Ordering Example/Bestellbeispiel

1 ad./pcs./stück AHFM-EN1004-D050-A22-Z05-H

Kesme Hesabı : S 367 / Cutting Calculation : P 367 / Schnittberechnung : 367

Montaj Ölçüleri : S 364 / Mounting Reference : P 364 / Montagehinweis : 364

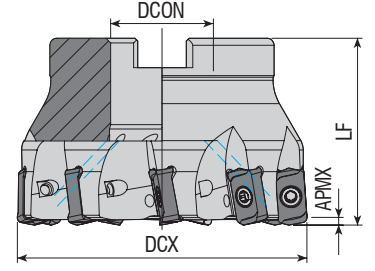

Takım Kodu Ordering Code Bestell-Bezeichnung	Stok Stock Lager	Takım Ölçüleri (mm) Dimension (mm) Abmessung (mm)					Kesici Uç Insert Wendeschneidplatte	Yedek Parçaları / Spare Parts / Ersatzteile		
		DCX	ZEPF	DCON	LF	APMX		Sıkma Vidası Screw Schraube	Tork Anahtar Torx Key Torx-Schlüssel	Montaj Vidası Mounting Screw Befestigungsschraube
AHFM-L003-D040-A16-Z06-H	●	40	6	16	40	1	LOGU 0303..		80-T08	2506-M8x30
AHFM-L003-D050-A22-Z07-H	●	50	7	22	40	1				2508-M10x30
AHFM-L003-D063-A22-Z09-H	●	63	9	22	40	1				

KYCR Ucuna Uygunur. / Compatiple with KYCR Insert. Kompatibel mit KYCR Wendepplatten.

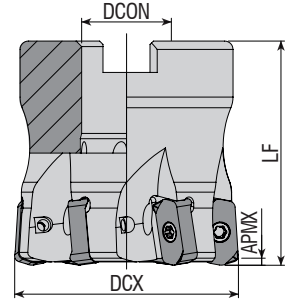

Takım Kodu Ordering Code Bestell-Bezeichnung	Stok Stock Lager	Takım Ölçüleri (mm) Dimension (mm) Abmessung (mm)					Kesici Uç Insert Wendeschneidplatte	Yedek Parçaları / Spare Parts / Ersatzteile		
		DCX	ZEPF	DCON	LF	APMX		Sıkma Vidası Screw Schraube	Tork Anahtar Torx Key Torx-Schlüssel	Montaj Vidası Mounting Screw Befestigungsschraube
AHFM-LN0303-D040-A16-Z06-H	●	40	6	16	40	12	LNMU 0303..		80-T08	2506-M8x30
AHFM-LN0303-D050-A22-Z07-H	●	50	7	22	50	12				2508-M10x30
AHFM-LN0303-D063-A22-Z09-H	●	63	9	22	50	12				

R: Sağ / Right / Rechts L: Sol/Left/Links

● Stokta / In Stock / Auf Lager ○ Stokta Yok / Non Stock Item / Kein Lagerartikel, Lieferzeit auf Anfrage  
TNGYL Ucuna Uygunur. / Compatiple with TNGYL Insert. Kompatibel mit TNGYL Wendepplatten.

Sipariş Örneği/Ordering Example/Bestellbeispiel

1 ad./pcs./stück AHFM-L003-D040-A16-Z06-H

Kesme Hesabı : S 367 / Cutting Calculation : P 367 / Schnittberechnung : 367

Montaj Ölçüleri : S 364 / Mounting Reference : P 364 / Montagehinweis : 364



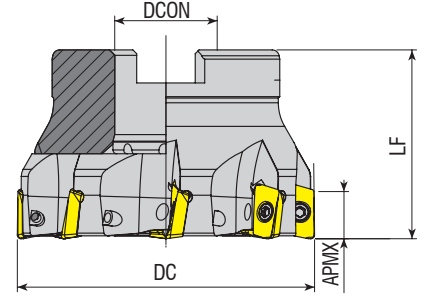

Takım Kodu Ordering Code Bestell-Bezeichnung	Stok Stock Lager	Takım Ölçüleri (mm) Dimension (mm) Abmessung (mm)					Kesici Uç Insert Wendeschneidplatte	Yedek Parçaları / Spare Parts / Ersatzteile			
		DC	ZEFP	DCON	LF	APMX		Sıkma Vidası Screw Schraube	Tork Anahtar Torx Key Torx-Schlüssel	Montaj Vidası Mounting Screw Befestigungsschraube	
AHFM-JD1003-D040-A16-Z06-H	●	40	6	16	40	9	JDMT 1003..	3008-M2.5x6	80-T08	2506-M8x30	
AHFM-JD1003-D063-A22-Z08-H	●	63	8	22	40	9				2508-M10x30	

MTSBH Ucuna Uygunur. / Compatiple with MTSBH Insert. Kompatibel mit MTSBH Wendeplatten.

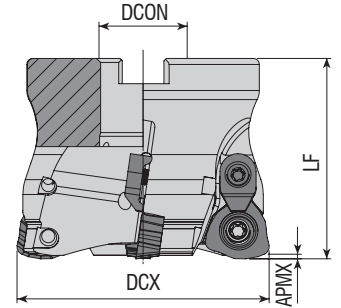

Takım Kodu Ordering Code Bestell-Bezeichnung	Stok Stock Lager	Takım Ölçüleri (mm) Dimension (mm) Abmessung (mm)					Kesici Uç Insert Wendeschneidplatte	Yedek Parçaları / Spare Parts / Ersatzteile				
		DCX	ZEFP	DCON	LF	APMX		Sıkma Vidası Screw Schraube	Baskı Pabucu Wedge Clamp Spannpratze	Baskı Vidası Clamp Screw Klemmschraube	Tork Anahtar Torx Key Torx-Schlüssel	Montaj Vidası Mounting Screw Befestigungsschraube
AHFMC-JD1204-D052-A22-Z03-H	●	52	3	22	50	1.5	JDMW 1204..	4615-M4x11	ACK-05	4015-M4x11	80-T15	2508-M10x30
AHFMC-JD1204-D052-A22-Z04-H	●	52	4	22	50	1.5						2510-M12x35
AHFMC-JD1204-D063-A22-Z05-H	●	63	5	22	50	1.5						2514-M16x35
AHFMC-JD1204-D080-A27-Z06-H	●	80	6	27	50	1.5						2408-M10x30
AHFMC-JD1204-D100-A32-Z07-H	●	100	7	32	50	1.5						2508-M10x30
AHFMC-JD1405-D052-A22-Z03-H	●	52	3	22	40	2						JDMW 1405..
AHFMC-JD1405-D063-A22-Z04-H	●	63	4	22	40	2				2508-M10x30		

R: Sağ / Right / Rechts L: Sol/Left/Links

● Stokta / In Stock / Auf Lager ○ Stokta Yok / Non Stock Item / Kein Lagerartikel, Lieferzeit auf Anfrage

MTSBH Ucuna Uygunur. / Compatiple with MTSBH Insert. Kompatibel mit MTSBH Wendeplatten.

Sipariş Örneği/Ordering Example/Bestelbeispiel

1 ad./pcs./stück AHFM-JD1003-D040-A16-Z06-H

Kesme Hesabı : S 367 / Cutting Calculation : P 367 / Schnittberechnung : 367

Montaj Ölçüleri : S 364 / Mounting Reference : P 364 / Montagehinweis : 364

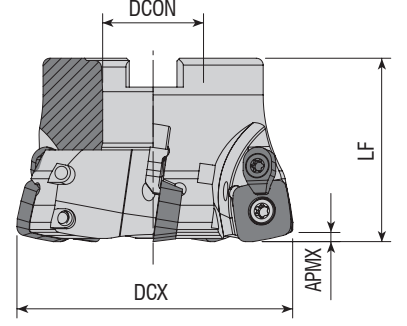

Takım Kodu Ordering Code Bestell-Bezeichnung	Stok Stock Lager	Takım Ölçüleri (mm) Dimension (mm) Abmessung (mm)					Kesici Uç Insert Wendeschneidplatte	Yedek Parçaları / Spare Parts / Ersatzteile				
		DCX	ZEFP	DCON	LF	APMX		Sıkma Vidası Screw Schraube	Baskı Pabucu Wedge Clamp Spannpratze	Baskı Vidası Clamp Screw Klemmschraube	Tork Anahtar Torx Key Torx-Schlüssel	Montaj Vidası Mounting Screw Befestigungsschraube
AHFMC-SD1204-D050-A22-Z04-H	●	50	4	22	40	1.8	SD.. 1204..	4015-M4x11	ACK-15	4015-M3.5x11	80-T15	2508-M10x30
AHFMC-SD1204-D063-A22-Z05-H	●	63	5	22	40	1.8						
AHFMC-SD1204-D080-A27-Z06-H	●	80	6	27	50	1.8						
AHFMC-SD1204-D100-A32-Z08-H	●	100	8	32	50	1.8						

ZCC Ucuna Uygun. / Compatible with ZCC Insert. Kompatibel mit ZCC Wendepalten.

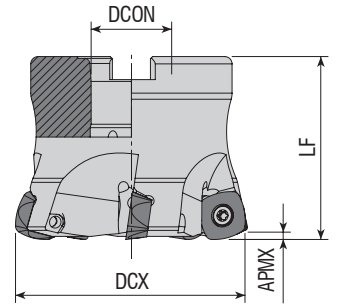
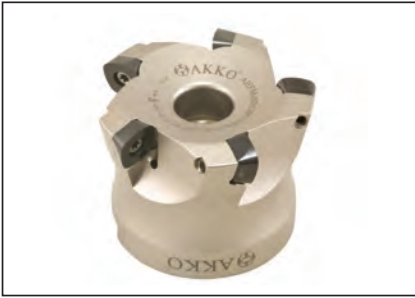

Takım Kodu Ordering Code Bestell-Bezeichnung	Stok Stock Lager	Takım Ölçüleri (mm) Dimension (mm) Abmessung (mm)					Kesici Uç Insert Wendeschneidplatte	Yedek Parçaları / Spare Parts / Ersatzteile		
		DCX	ZEFP	DCON	LF	APMX		Sıkma Vidası Screw Schraube	Tork Anahtar Torx Key Torx-Schlüssel	Montaj Vidası Mounting Screw Befestigungsschraube
AHFM-SD1205-D052-A22-Z04-H	●	52	4	22	50	2	SD.. 1205..	4015-M4x11	80-T15	2508-M10x30
AHFM-SD1205-D052-A22-Z05-H	●	52	5	22	50	2				
AHFM-SD1205-D066-A22-Z05-H	●	66	5	22	50	2				
AHFM-SD1205-D066-A22-Z06-H	●	66	6	22	50	2				
AHFM-SD1205-D080-A27-Z06-H	●	80	6	27	70	2				

R: Sağ / Right / Rechts L: Sol/Left/Links  
● Stokta / In Stock / Auf Lager ○ Stokta Yok / Non Stock Item / Kein Lagerartikel, Lieferzeit auf Anfrage  
HTCH Ucuna Uygun. / Compatible with HTCH Insert. Kompatibel mit HTCH Wendepalten.

Sipariş Örneği/Ordering Example/ Bestellbeispiel  
1 ad./pcs./stück AHFM-SD1204-D050-A22-Z04-H  
Kesme Hesabı : S 367 / Cutting Calculation : P 367 / Schnittberechnung : 367  
Montaj Ölçüleri : S 364 / Mounting Reference : P 364 / Montagehinweis : 364

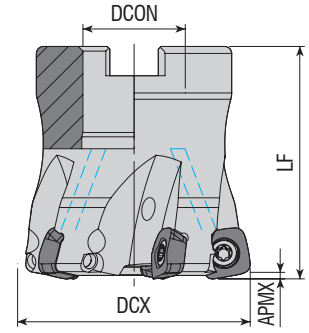

Takım Kodu Ordering Code Bestell-Bezeichnung	Stok Stock Lager	Takım Ölçüleri (mm) Dimension (mm) Abmessung (mm)					Kesici Uç Insert Wendeschneidplatte	Yedek Parçaları / Spare Parts / Ersatzteile		
		DCX	ZEFP	DCON	LF	APMX		Sıkma Vidası Screw Schraube	Tork Anahtar Torx Key Torx-Schlüssel	Montaj Vidası Mounting Screw Befestigungsschraube
AHFM-SO1004-D050-A22-Z05-H	●	50	5	22	50	1.5	SOMT 1004..	4015-M4x11	80-T15	2508-M10x30 2510-M12x35
AHFM-SO1004-D063-A22-Z06-H	●	63	6	22	50	1.5				
AHFM-SO1004-D080-A27-Z07-H	●	80	7	27	63	1.5				

KYCR Ucuna Uygunudur. / Compatible with KYCR Insert. Kompatibel mit KYCR Wendepfatten.

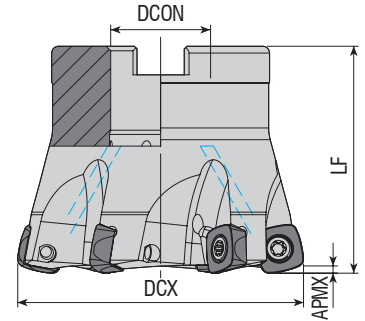

Takım Kodu Ordering Code Bestell-Bezeichnung	Stok Stock Lager	Takım Ölçüleri (mm) Dimension (mm) Abmessung (mm)					Kesici Uç Insert Wendeschneidplatte	Yedek Parçaları / Spare Parts / Ersatzteile		
		DCX	ZEFP	DCON	LF	APMX		Sıkma Vidası Screw Schraube	Tork Anahtar Torx Key Torx-Schlüssel	Montaj Vidası Mounting Screw Befestigungsschraube
AHFM-SP1004-D050-A22-Z05-H	●	50	5	22	50	1.5	SPNW 1004..	3015-M3.5x9	80-T15	2508-M10x30
AHFM-SP1004-D052-A22-Z05-H	●	52	5	22	50	1.5				
AHFM-SP1004-D063-A22-Z06-H	●	63	6	22	50	1.5				

R: Sağ / Right / Rechts L: Sol/Left/Links

● Stokta / In Stock / Auf Lager ○ Stokta Yok / Non Stock Item / Kein Lagerartikel, Lieferzeit auf Anfrage  
DJT Ucuna Uygunudur. / Compatible with DJT Insert. Kompatibel mit DJT Wendepfatten.

Sipariş Örneği/Ordering Example/Bestellbeispiel

1 ad./pcs./stück AHFM-SO1004-D050-A22-Z05-H

Kesme Hesabı : S 367 / Cutting Calculation : P 367 / Schnittberechnung : 367

Montaj Ölçüleri : S 364 / Mounting Reference : P 364 / Montagehinweis : 364

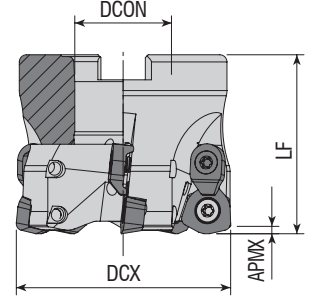

Takım Kodu Ordering Code Bestell-Bezeichnung	Stok Stock Lager	Takım Ölçüleri (mm) Dimension (mm) Abmessung (mm)					Kesici Uç Insert Wendeschneidplatte	Yedek Parçaları / Spare Parts / Ersatzteile				
		DCX	ZEFP	DCON	LF	APMX		Sıkma Vidası Screw Schraube	Baskı Pabucu Wedge Clamp Spannpratze	Baskı Vidası Clamp Screw Klemmschraube	Tork Anahtar Torx Key Torx-Schlüssel	Montaj Vidası Mounting Screw Befestigungsschraube
AHFMC-WD06T3D-D042-A16-Z04-H	●	42	4	16	45	1.5	WD.W 06T3..	3015-M3.5x9	ACK-15	4015-M3.5x11	80-T15	2506-M8x30
AHFMC-WD06T3D-D050-A22-Z05-H	●	50	5	22	50	1.5						
AHFMC-WD06T3D-D052-A22-Z05-H	●	52	5	22	50	1.5						
AHFMC-WD0805D-D052-A22-Z04-H	●	52	4	22	50	2	WD.W 0805..	4020-M4.5x12	ACK-19	4020-M4.5x12	80-T20	2508-M10x30
AHFMC-WD0805D-D063-A22-Z05-H	●	63	5	22	50	2						
AHFMC-WD0805D-D063-A27-Z05-H	●	63	5	27	50	2						
AHFMC-WD0805D-D066-A27-Z05-H	●	66	5	27	50	2						
AHFMC-WD0805D-D080-A27-Z05	●	80	5	27	50	2						
AHFMC-WD0805D-D100-A32-Z06	●	100	6	32	50	2						
AHFMC-WD10X6D-D125-B40-Z06	●	125	6	40	63	2.5	WD.W 10X6..					2510-M12x35
AHFMC-WD10X6D-D160-C40-Z07	●	160	7	40	63	2.5						

DJT Ucuna Uygundur. / Compatible with DJT Insert. Kompatibel mit DJT Wendepfatten.

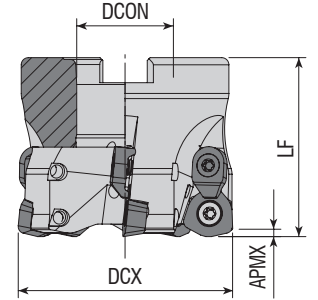

Takım Kodu Ordering Code Bestell-Bezeichnung	Stok Stock Lager	Takım Ölçüleri (mm) Dimension (mm) Abmessung (mm)					Kesici Uç Insert Wendeschneidplatte	Yedek Parçaları / Spare Parts / Ersatzteile				
		DCX	ZEFP	DCON	LF	APMX		Sıkma Vidası Screw Schraube	Baskı Pabucu Wedge Clamp Spannpratze	Baskı Vidası Clamp Screw Klemmschraube	Tork Anahtar Torx Key Torx-Schlüssel	Montaj Vidası Mounting Screw Befestigungsschraube
AHFMC-WD0804-D040-A16-Z04-H	●	40	4	16	40	1.5	WDMT 0804..	4010-M3x8	ACK-15	4010-M3x8	80-T10	2506-M8x30
AHFMC-WD0804-D050-A22-Z04-H	●	50	4	22	50	1.5						
AHFMC-WD1205-D050-A22-Z04-H	●	50	4	22	50	3	WDMT 1205..	1415-M4x11	ACK-05	4015-M4x11	80-T15	2508-M10x30
AHFMC-WD1205-D052-A22-Z04-H	●	52	4	22	50	3						
AHFMC-WD1205-D063-A22-Z05-H	●	63	5	22	50	3						
AHFMC-WD1205-D080-A27-Z06-H	●	80	6	27	63	3						

R: Sağ / Right / Rechts L: Sol/Left/Links

● Stokta / In Stock / Auf Lager ○ Stokta Yok / Non Stock Item / Kein Lagerartikel, Lieferzeit auf Anfrage  
SMTM Ucuna Uygundur. / Compatible with SMTM Insert. Kompatibel mit SMTM Wendepfatten.

Sipariş Örneği/Ordering Example/Bestellbeispiel

1 ad./pcs./stück AHFMC-WD06T3D-D042-A16-Z04-H

Kesme Hesabı : S 367 / Cutting Calculation : P 367 / Schnittberechnung : 367

Montaj Ölçüleri : S 364 / Mounting Reference : P 364 / Montagehinweis : 364



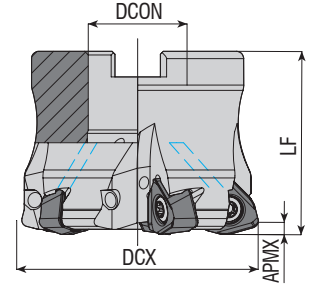

Takım Kodu Ordering Code Bestell-Bezeichnung	Stok Stock Lager	Takım Ölçüleri (mm) Dimension (mm) Abmessung (mm)					Kesici Uç Insert Wendeschneidplatte	Yedek Parçaları / Spare Parts / Ersatzteile		
		DCX	ZEFP	DCON	LF	APMX		Sıkma Vidası Screw Schraube	Tork Anahtar Torx Key Torx-Schlüssel	Montaj Vidası Mounting Screw Befestigungsschraube
AHFM-WN0907-D050-A22-Z04-H	●	50	4	22	50	3	WNMU 0907..	1020-M5x14	80-T20	2508-M10x30
AHFM-WN0907-D052-A22-Z04-H	●	52	4	22	50	3				
AHFM-WN0907-D063-A22-Z05-H	●	63	5	22	50	3				
AHFM-WN0907-D066-A27-Z05-H	●	66	5	27	50	3				
AHFM-WN0907-D080-A27-Z06-H	●	80	6	27	50	3				
AHFM-WN0907-D100-A32-Z07-H	●	100	7	32	50	3				

DJT Ucuna Uygundur. / Compatible with DJT Insert. Kompatibel mit DJT Wendeplatten.

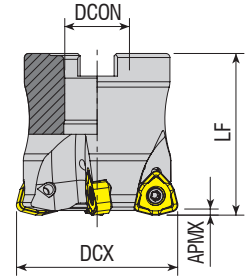

Takım Kodu Ordering Code Bestell-Bezeichnung	Stok Stock Lager	Takım Ölçüleri (mm) Dimension (mm) Abmessung (mm)					Kesici Uç Insert Wendeschneidplatte	Yedek Parçaları / Spare Parts / Ersatzteile		
		DCX	ZEFP	DCON	LF	APMX		Sıkma Vidası Screw Schraube	Tork Anahtar Torx Key Torx-Schlüssel	Montaj Vidası Mounting Screw Befestigungsschraube
AHFM-WN09T3-D040-A16-Z04-H	●	40	4	16	40	1.5	WNMX 09T3..	4010-M3x8	80-T10	2506-M8x30
AHFML-WN09T3-D040-A16-Z04-H	●	40	4	16	40	1.5				
AHFM-WN09T3-D050-A22-Z05-H	●	50	5	22	40	1.5				
AHFML-WN09T3-D050-A22-Z05-H	●	50	5	22	40	1.5				
AHFM-WN09T3-D063-A22-Z06-H	●	63	6	22	40	1.5				

R: Sağ / Right / Rechts L: Sol/Left/Links

● Stokta / In Stock / Auf Lager ○ Stokta Yok / Non Stock Item / Kein Lagerartikel, Lieferzeit auf Anfrage  
KRLY Ucuna Uygundur. / Compatible with KRLY Insert. Kompatibel mit KRLY Wendeplatten.

Sipariş Örneği/Ordering Example/Bestellbeispiel

1 ad./pcs./stück AHFM-WN0907-D050-A22-Z04-H

Kesme Hesabı : S 367 / Cutting Calculation : P 367 / Schnittberechnung : 367

Montaj Ölçüleri : S 364 / Mounting Reference : P 364 / Montagehinweis : 364

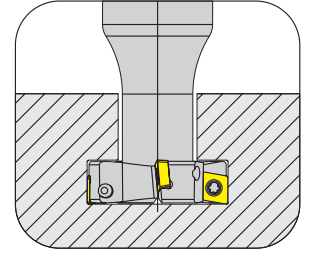
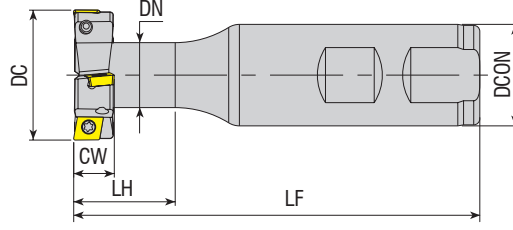

**Takım Kodu**  
**Ordering Code**  
*Bestell-Bezeichnung*

Stok  
Stock  
Lager

ZEPF  
Toplam  
Total  
Gesamt

Etikli  
Effective  
Effektiv

DC

CW

DCON

LF

DN

LH

Kesici Uç  
Insert  
Wendeschneidplatte

Sıkma Vidası  
Screw  
Schraube

Tork Anahtar  
Torx Key  
Torx-Schlüssel

Yedek Parçaları / Spare Parts / Ersatzteile

Takım Kodu Ordering Code Bestell-Bezeichnung	Stok Stock Lager	ZEPF		Takım Ölçüleri (mm) Dimension (mm) Abmessung (mm)						Kesici Uç Insert Wendeschneidplatte	Sıkma Vidası Screw Schraube	Tork Anahtar Torx Key Torx-Schlüssel
		Toplam Total Gesamt	Etikli Effective Effektiv	DC	CW	DCON	LF	DN	LH			
ATSM90-CC06-D17X8-W16-L85-Z02	●	2	1	17	8	16	85	10	16	CC.. 0602..	3008-M2.5x6	80-T08
ATSM90-CC06-D32X8-W25-L100-Z04	●	4	2	32	8	25	100	16	23			
ATSM90-CC06-D28X8-W20-L66-Z04	●	4	2	28	8	20	66	14	15.5			
ATSM90-CC06-D45.5X8-W25-L100-Z06	●	6	3	45.5	8	25	100	12	30			
ATSM90-CC06-D63X8-W32-L125-Z08	●	8	4	63	8	32	125	31.5	30			
ATSM90-CC06-D18X9-W16-L90-Z02	●	2	1	18	9	16	90	10	16			
ATSM90-CC06-D20X9-W16-L85-Z04	●	4	2	20	9	16	85	10	16			
ATSM90-CC06-D23X10-W20-L90-Z04	●	4	2	23	10	20	90	12	25			
ATSM90-CC06-D32X10-W25-L100-Z04	●	4	2	32	10	25	100	16	25			
ATSM90-CC06-D45X10-W32-L120-Z06	●	6	3	45	10	32	120	20	25			
ATSM90-CC06-D25X11-W25-L100-Z04	●	4	2	25	11	25	100	13	20	CC.. 09T3..	4015-M3.5x9	80-T15
ATSM90-CC09-D30X12-W25-L100-Z04	●	4	2	30	12	25	100	16	25			
ATSM90-CC09-D32X12-W25-L100-Z02	●	2	1	32	12	25	100	16	25			
ATSM90-CC09-D32X12-W25-L100-Z04	●	4	2	32	12	25	100	16	25			
ATSM90-CC09-D32X14-W25-L100-Z04	●	4	2	32	14	25	100	16	25			
ATSM90-CC09-D37X16-W32-L120-Z04	●	4	2	37	16	32	120	17	30			
ATSM90-CC09-D40X17-W32-L120-Z04-H	●	4	2	40	17	32	120	19	30			
ATSM90-CC09-D42X17-W32-L120-Z04	●	4	2	42	17	32	120	19	30	CC.. 1204..	1020-M5x11	80-T20
ATSM90-CC12-D47X20-W32-L120-Z04	●	4	2	47	20	32	120	25	45			
ATSM90-CC12-D52X21-W32-L120-Z04	●	4	2	52	21	32	120	25	45			
ATSM90-CC12-D50X22-W32-L120-Z04	●	4	2	50	22	32	120	25	45			
ATSM90-CC12-D55X22-W32-L120-Z04	●	4	2	55	22	32	120	25	45			

R: Sağ / Right / Rechts L: Sol/Left/Links

● Stokta / In Stock / Auf Lager ○ Stokta Yok / Non Stock Item / Kein Lagerartikel, Lieferzeit auf Anfrage

Sipariş Örneği/Ordering Example/Bestellbeispiel

1 ad./pcs./stück ATSM90-CC06-D17X8-W16-L85-Z02

Kesme Hesabı : S 367 / Cutting Calculation : P 367 / Schnittberechnung : 367



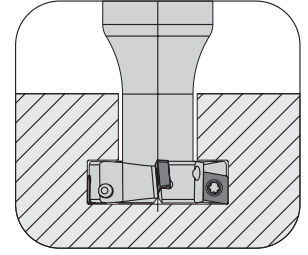
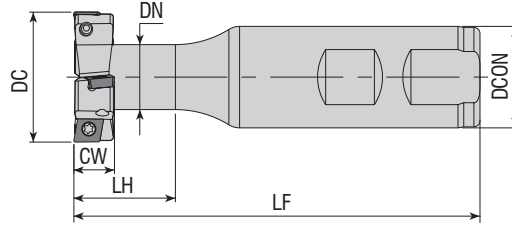

**Takım Kodu**  
**Ordering Code**  
*Bestell-Bezeichnung*

Stok  
Stock  
Lager

Takım Ölçüleri (mm)  
Dimension (mm)  
Abmessung (mm)

Kesici Uç  
Insert  
Wendeschneidplatte

Yedek Parçaları / Spare Parts / Ersatzteile

Sıkma Vidası  
Screw  
Schraube

Tork Anahtar  
Torx Key  
Torx-Schlüssel

ZEPF  
Toplam  
Total  
Gesamt

Etkili  
Effective  
Effektiv

DC CW DCON LF DN LH



ATSM90-SP..05-D22.5X5-W25-L100-Z04	●	4	2	22.5	5	25	100	12	25	SPMG 050204 TGTC UCUNA UYGUNDUR. FOR TGTC INSERT. Kompatibel mit TGTC Wendepfatten	3006-M2x4	80-T06
ATSM90-SP..05-D30X5-W25-L100-Z04	●	4	2	30	5	25	100	10	25			
ATSM90-SPGT0502-D63X6-W32-L125-Z10	●	10	5	63	6	32	125	31	30	SPGT 050204		
ATSM90-SPGT0904-D32X14-W32-L120-Z04-H	●	4	2	32	14	32	120	17.5	30	SPGT 090408 ZCC UCUNA UYGUNDUR. FOR ZCC INSERT. Kompatibel mit ZCC Wendepfatten	4015-M3.5x9	80-T15
ATSM90-SPGT0904-D37X16-W32-L120-Z04-H	●	4	2	37	16	32	120	21	40			
ATSM90-SPGT0904-D42X17-W32-L120-Z04-H	●	4	2	42	17	32	120	21	40			
ATSM90-SPGT1104-D47X20-W32-L120-Z04-H	●	4	2	47	20	32	120	24	45	SPGT 110408	4015-M4x11	
ATSM90-SP..06-D80X7-W32-L120-Z10	●	10	5	80	7	32	120	32	30	SPMG 060204 TGTC UCUNA UYGUNDUR. FOR TGTC INSERT. Kompatibel mit TGTC Wendepfatten	3007-M2.2x5	80-T07

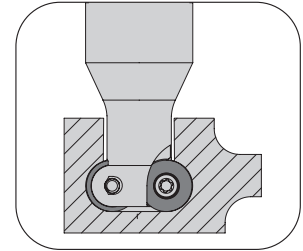
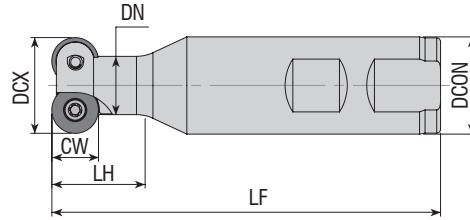

**Takım Kodu**  
**Ordering Code**  
*Bestell-Bezeichnung*

Stok  
Stock  
Lager

Takım Ölçüleri (mm)  
Dimension (mm)  
Abmessung (mm)

Kesici Uç  
Insert  
Wendeschneidplatte

Yedek Parçaları / Spare Parts / Ersatzteile

Sıkma Vidası  
Screw  
Schraube

Tork Anahtar  
Torx Key  
Torx-Schlüssel

ZEPF

DCX

CW

DCON

LF

DN

LH



ATSMR-RD0702-D17-W16-L90-Z02	●	2	17	7	16	90	10	12	RD.. 0702	3008-M2.5x6	80-T08
ATSMR-RD0702-D25-W16-L90-Z03	●	3	25	7	16	90	15	12			
ATSMR-RD0702-D35-W25-L100-Z05	●	5	35	7	25	100	20	20	RD.. 1003	4015-M3.5x9	80-T15
ATSMR-RD1003-D21-W25-L100-Z02	●	2	21	10	25	100	12	20			
ATSMR-RD1003-D80-W32-L165-Z06-H	●	6	80	10	32	165	30	31.5			
ATSMR-RD12T3-D25-W25-L100-Z02	●	2	25	12	25	100	15	24	RD.. 12T3		
ATSMR-RD12T3-D80-W32-L165-Z06-H	●	6	80	12	32	165	30	31.5			
ATSMR-RD1604-D34-W32-L110-Z02	●	2	34	16	32	110	20	30	RD.. 1604	4015-M4.5x11	

R: Sağ / Right / Rechts L: Sol/Left/Links

● Stokta / In Stock / Auf Lager ○ Stokta Yok / Non Stock Item / Kein Lagerartikel, Lieferzeit auf Anfrage  
ISO Ucuna Uygundur. / Compatible with ISO Insert. Kompatibel mit ISO Wendepfatten.

Sipariş Örneği/Ordering Example/Bestellbeispiel

1 ad./pcs./stück ATSM90-SP.05-D22.5X5-W25-L100-Z04

Kesme Hesabı : S 367 / Cutting Calculation : P 367 / Schnittberechnung : 367

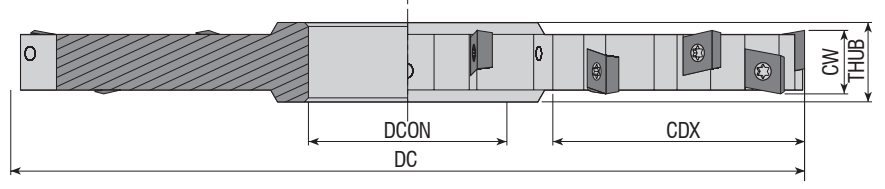

**Takım Kodu**  
**Ordering Code**  
*Bestell-Bezeichnung*

Stok  
Stock  
Lager

ZEFP		DC	CW	CDX	DCON	THUB
Toplam Total Gesamt	Etkili Effektiv Effektiv					

Takım Ölçüleri (mm)  
Dimension (mm)  
Abmessung (mm)

Kesici Uç  
Insert  
Wendeschneidplatte

Yedek Parçaları / Spare Parts / Ersatzteile

Sıkma Vidası  
Screw  
Schraube

Tork Anahtar  
Torx Key  
Torx-Schlüssel

ASDM-SPGT05-D80x6-d27-Z10	●	10	5	80	6	17	27	10
ASDM-SPGT05-D100x6-d32-Z12	●	12	6	100	6	25	32	10
ASDM-SPGT05-D125x6-d40-Z14	●	14	7	125	6	35	40	10
ASDM-SPGT05-D160x6-d40-Z18	●	18	9	160	6	52	40	10
ASDM-SPGT06-D80x7-d27-Z10	●	10	5	80	7	17	27	11
ASDM-SPGT06-D100x7-d32-Z12	●	12	6	100	7	25	32	11
ASDM-SPGT06-D125x7-d40-Z14	●	14	7	125	7	35	40	11
ASDM-SPGT06-D160x7-d40-Z16	●	16	8	160	7	52	40	11
ASDM-SPGT06-D200x7-d40-Z18	●	18	9	200	7	70	40	11
ASDM-SPGT07-D100x10-d32-Z12	●	12	6	100	10	25	32	11

<b>SPGT 050204</b> ZCC UCUNA UYGUNDUR. FOR ZCC INSERT. <i>Kompatibel mit ZCC Wendeschneidplatten</i>	3006-M2x4	80-T06
<b>SPGT 060204</b> ZCC UCUNA UYGUNDUR. FOR ZCC INSERT. <i>Kompatibel mit ZCC Wendeschneidplatten</i>	3007-M2.2x5	80-T07
<b>SPGT 07T308</b>	3008-M2.5x6	80-T08

R: Sağ / Right / Rechts L: Sol/Left/Links

● Stokta / In Stock / Auf Lager ○ Stokta Yok / Non Stock Item / Kein Lagerartikel, Lieferzeit auf Anfrage

Sipariş Örneği/Ordering Example/Bestellbeispiel

1 ad./pcs./stück ASDM-SPGT05-D80x6-d27-Z10

Kesme Hesabı : S 367 / Cutting Calculation : P 367 / Schnittberechnung : 367





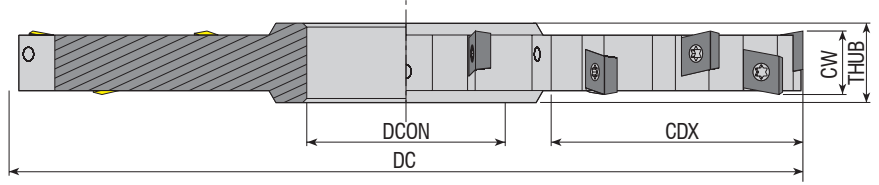

**Takım Kodu**  
**Ordering Code**  
*Bestell-Bezeichnung*

Stok  
Stock  
Lager

Takım Ölçüleri (mm)  
Dimension (mm)  
Abmessung (mm)

Kesici Uç  
Insert  
Wendeschneidplatte

Yedek Parçaları / Spare Parts / Ersatzteile

Sıkma Vidası  
Screw  
Schraube

Tork Anahtar  
Torx Key  
Torx-Schlüssel

ZEPF  
Toplam  
Total  
Gesamt

Etkili  
Effective  
Effektiv

DC

CW

CDX

DCON

THUB



ASDM-CC06-D80x8-d27-Z10	●	10	5	80	8	17	27	12
ASDM-CC06-D100x8-d32-Z12	●	12	6	100	8	25	32	12
ASDM-CC06-D125x8-d40-Z14	●	14	7	125	8	35	40	12
ASDM-CC06-D160x8-d40-Z16	●	16	8	160	8	52	40	12
ASDM-CC06-D200x8-d40-Z18	●	18	9	200	8	70	40	12
ASDM-CC06-D80x10-d27-Z10	●	10	5	80	10	17	27	14
ASDM-CC06-D100x10-d32-Z12	●	12	6	100	10	25	32	14
ASDM-CC06-D125x10-d40-Z14	●	14	7	125	10	35	40	14
ASDM-CC06-D160x10-d40-Z16	●	16	8	160	10	52	40	14
ASDM-CC06-D200x10-d40-Z18	●	18	9	200	10	70	40	14
ASDM-CC09-D80x12-d27-Z08	●	8	4	80	12	17	27	16
ASDM-CC09-D100x12-d32-Z10	●	10	5	100	12	25	32	16
ASDM-CC09-D125x12-d40-Z12	●	12	6	125	12	35	40	16
ASDM-CC09-D160x12-d40-Z14	●	14	7	160	12	52	40	16
ASDM-CC09-D200x12-d40-Z16	●	16	8	200	12	70	40	16
ASDM-CC09-D80x14-d27-Z08	●	8	4	80	14	17	27	18
ASDM-CC09-D100x14-d32-Z10	●	10	5	100	14	25	32	18
ASDM-CC09-D125x14-d40-Z12	●	12	6	125	14	35	40	18
ASDM-CC09-D160x14-d40-Z14	●	14	7	160	14	52	40	18
ASDM-CC09-D200x14-d40-Z16	●	16	8	200	14	70	40	18
ASDM-CC12-D80x16-d27-Z06	●	6	3	80	16	17	27	20
ASDM-CC12-D100x16-d32-Z08	●	8	4	100	16	25	32	20
ASDM-CC12-D125x16-d40-Z10	●	10	5	125	16	35	40	20
ASDM-CC12-D160x16-d40-Z12	●	12	6	160	16	52	40	20
ASDM-CC12-D200x16-d40-Z14	●	14	7	200	16	70	40	20
ASDM-CC12-D80x18-d27-Z06	●	6	3	80	18	17	27	22
ASDM-CC12-D100x18-d32-Z08	●	8	4	100	18	25	32	22
ASDM-CC12-D125x18-d40-Z10	●	10	5	125	18	35	40	22
ASDM-CC12-D160x18-d40-Z12	●	12	6	160	18	52	40	22
ASDM-CC12-D200x18-d40-Z14	●	14	7	200	18	70	40	22
ASDM-CC12-D250x18-d40-Z16	●	16	8	250	18	90	40	22
ASDM-CC12-D80x20-d27-Z06	●	6	3	80	20	17	27	24
ASDM-CC12-D100x20-d32-Z08	●	8	4	100	20	25	32	24
ASDM-CC12-D125x20-d40-Z10	●	10	5	125	20	35	40	24
ASDM-CC12-D160x20-d40-Z12	●	12	6	160	20	52	40	24
ASDM-CC12-D200x20-d40-Z14	●	14	7	200	20	70	40	24
ASDM-CC12-D250x20-d40-Z16	●	16	8	250	20	90	40	24

**CC.. 0602..**  
**ISO UCUNA**  
**UYGUNDUR.**  
FOR ISO INSERT.  
Kompatibel mit ISO Wendepfatten

3008-M2.5x6

80-T08

**CC.. 09T3..**  
**ISO UCUNA**  
**UYGUNDUR.**  
FOR ISO INSERT.  
Kompatibel mit ISO Wendepfatten

4015-M3.5x11

80-T15

**CC.. 1204..**  
**ISO UCUNA**  
**UYGUNDUR.**  
FOR ISO INSERT.  
Kompatibel mit ISO Wendepfatten

1020-M5x11

80-T20

R: Sağ / Right / Rechts L: Sol/Left/Links

● Stokta / In Stock / Auf Lager ○ Stokta Yok / Non Stock Item / Kein Lagerartikel, Lieferzeit auf Anfrage

Sipariş Örneği/Ordering Example/Bestellbeispiel

1 ad./pcs./stück ASDM-CC06-D80x8-d27-Z10

Kesme Hesabı : S 367 / Cutting Calculation : P 367 / Schnittberechnung : 367

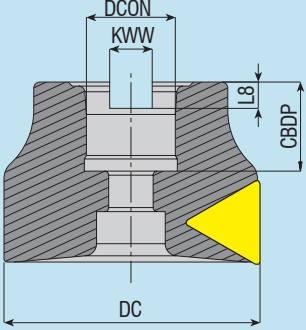
A TIP / A TYPE / A-Typ	DC	DCON	DBC	KWW	L8	CBDP
	40	16	-	8.4	5.6	20
	50	22	-	10.4	6.3	22
	63	22	-	10.4	6.3	22
	80	27	-	12.4	7	25
	100	32	-	14.4	8	26

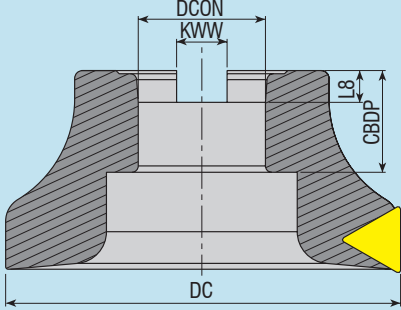
B TIP / B TYPE / B-Typ	DC	DCON	DBC	KWW	L8	CBDP
	125	40	-	16.4	9	32

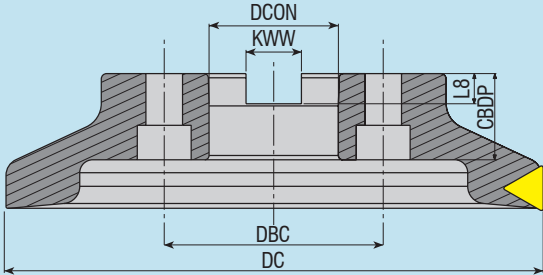
C TIP / C TYPE / C-Typ	DC	DCON	DBC	KWW	L8	CBDP
	160	40	66.7	16.4	9	32
	200	60	101.6	25.7	14	40
	250	60	101.6	25.7	14	40

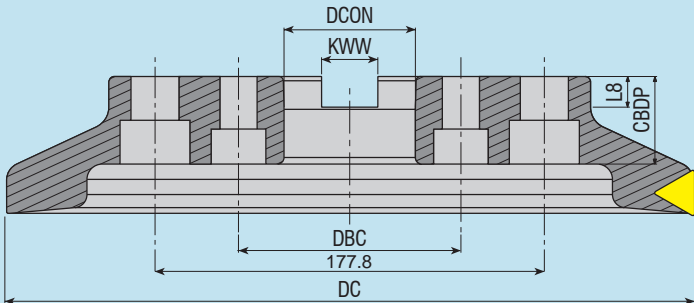
D TIP / D TYPE / D-Typ	DC	DCON	DBC	KWW	L8	CBDP
	315	60	101.6	25.7	14	40

## TAKMA UÇLU MATKAP (U-DRILL) KULLANMA KILAVUZU

Matkabınızı CNC torna tezgahına bağlamadan önce taretin merkezden kaçık olup olmadığını kontrol etmeniz gerekir. Şayet taretinizde kaçıklık varsa, takma uçlu matkabınızı kesinlikle kullanmayınız. Taretin düzeltilmesi için yapılması gereken işlemler ;

1. Taretin tutucusuna kullanacağınız takma uçlu matkabın çapında ve boyunda üzeri hassas olan silindirik bir parça bağlanır ve tezgahın X değeri sıfıra getirilir.
2. Tezgahın aynasına mıknatıslı komprotör saati yerleştirilir. Saatin uç kısmı tarete bağlanmış olduğumuz parçanın üstüne temas ettirilir.
3. Aynanın üzerine bağlanmış olduğumuz mıknatıslı komprotör ayna ile beraber 360 derece döndürülerek saatteki değişim oranına göre taretin sıfırlanması sağlanır.

### TAKMA UÇLU MATKABINIZI CNC TORNANIZDA DAHA VERİMLİ KULLANMANIZ İÇİN GEREKLİ OLAN KESME HIZLARI ve DEVİRLERİ :

Grup No.	Malzemenin Cinsi	Malzemenin Öz.	Kesme Hızı Vc (m/dk)
1	Çok Yumuşak İş Çelikleri	C1010, Otomat vb.	220
2	İmalat Çelik ve Döküm Malz.	C1030 - 106 vb.	200
3	Takım ve İmalat Çeşitleri	CK-45, 4140, 7131 vb.	170
4	Sıcak İş ve Paslanmaz Çelikler	İmpaks vb.	150

Devir hesabı yapabilmek için önce malzemeyi seçiniz. Seçtiğiniz malzemenin kesme hızını (Vc) 1000 ile çarpıp 3.14'e bölmeliyiz. Çıkan değeri matkap çapına bölmeliyiz. **ÖRNEK** : Malzememiz takım ve imalat çeliği (3. grup), matkap çapı 25 mm kesme hızı 170 ise  $170 \times 1000 = 170000 / 3.14 = 54140$ ,  $54140 / 25 = 2166$  devir çıkar (Tezgahın İş Mili Devri). Tezgahın ilerlemesi kullanacağınız uç ile de alakalı olup 0.05 ile 0.10 arasında değişim gösterir. Kullanıcı kesici ucun kesişine göre bunu ayarlar.

### İŞLEME MERKEZLERİ İÇİN İLERLEME HESABI :

Yukarıdaki hesaplamalarla bulmuş olduğunuz 2166 iş mili devrini, kesici uç ilerlemesi (mm/devir) 0.05 ile 0.10 arasındaki ilerleme seçenekleri ile çarpılır. **ÖRNEK 1** :  $2166 \times 0.05 = 108$  **ÖRNEK 2** :  $2116 \times 0.10 = 217$  çıkan sonuçlar 108 ve 217 işleme merkezleri için ilerleme mm/dakika hesabıdır.

Not: D4 ve üzeri takma uçlu matkaplarda tezgahın içten su verme basıncının en az 6 bar olması gerekmektedir.

## USER'S GUIDE FOR AKKO U-DRILLS

Before connecting your U-Drill to CNC lathe, you have to check if the turret is eccentric from the center or not. If there is any eccentricity in your turret, never use your U-Drill;

Processes that should be done to fix the turret :

1. A cylindrical part whose surface is precision and whose length and diameter is the same with the U-Drill that you will use, should be mounted to the holder of turret and X value of the lathe should be brought to zero ( 0 ).
2. Comparator should be mounted to chuck. The end of the comparator should be contacted ( touched ) to the surface of the part that we mounted on the turret.
3. The comparator that we mounted on the chuck should be turned 360-degree with the chuck and turret should be zeroed by that turning according to changing rate of comparator.

### CUTTING SPEED AND REVOLUTION THAT ARE NEEDED FOR USING ( RUNNING ) YOUR U-DRILLS MORE PRODUCTIVELY

Grup No.	Material	Material Type	Cutting Speed Vc ( m/m)
1	Non-alloy steel and free cutting steel	C1010. Automat etc.	220
2	Low alloy steel and cast steel	C1030 - 106 etc.	200
3	Alloy steel and tool steel	CK-45, 4140, 7131 etc.	170
4	Hot Work Steel and Stainless Steel	Impax etc.	150

P.S. : The cutting speed may be concerned with the type of the insert that you use.

Fistly, choose the material to make calculation of revolution. You should multiply the cutting speed (Vc) of the material that you chose by 1000 and divide by 3.14. You should divide the value that you found by the diameter of U-Drill. For Example : If our material is alloy steel and tool steel ( 3rd group ), diameter of the U-Drill is 25 mm, cutting speed is 170, we should calculate as following;  $170 \times 1000 = 170000 / 3.14 = 54140$ ,  $54140 / 25 = 2166$  rpm is the result that we found ( Spindle Speed ) Feed rate of the lathe is concerned with the U-Drill that you will use and changes between 0.05 and 0.10. The user sets it according to cut of cutting insert.

### FEED CALCULATION FOR CENTRAL MACHINE :

2166 spindle speed, that we found as a result of above mentioned calculation, should be multiplied by cutting insert feed ( mm/r ) between 0.05 and 0.10 feed choisses. Example 1 :  $2166 \times 0.05 = 108$

Example 2 :  $2116 \times 0.10 = 217$  The results 108 and 217 are the feed mm/m calculation for central machine.

Note: Cooling water pressure of lathe must be minimum 6 bar for our D4 u-drills and u-drills longer than D4.

## GEBRAUCHSANLEITUNG FÜR AKKO-VOLLBOHRER

Bevor Sie den Vollbohrer auf die Drehmaschine montieren, prüfen Sie bitte ob der Revolverkopf zentrisch sitzt. Sollte der Revolverkopf aus der Mitte stehen, benutzen Sie den Vollbohrer bitte nicht. Auf folgende Weise können Sie den Revolverkopf zentrieren:

1. Setzen Sie ein präzises Drehteil, das die gleiche Länge und den gleichen Durchmesser hat wie der eingesetzte Vollbohrer, in den Halter vom Revolverkopf und justieren Sie den X-Wert der Drehmaschine auf null.
2. Setzen Sie bitte einen Messtaster in das Spannfutter ein. Der Fühler des Messtasters sollte mit der Oberfläche des Präzisionsteils im Revolver Kontakt haben.
3. Drehen Sie nun das Spannfutter mit dem Messtaster um 360°. Die angezeigte Abweichung zwischen Futter und Revolver sollte null betragen.

### SNITTGESCHWINDIGKEIT UND DREHZAHL UM DIE VOLLBOHRER WIRTSCHAFTLICH EINZUSETZEN

Hauptgruppe	Hauptgruppe	Materialbezeichnung	Schnittgeschwindigkeit vc (m/min.)
1	Nicht Legierter Stahl und Automatenstahl	C1010. Automatenstahl	220
2	Niedrig Legierter Stahl und Stahlguss	C1030 - 106 vb.	200
3	Legierter Stahl und Werkzeugstahl	CK-45, 4140, 7131 vb.	170
4	Warmarbeitsstahl und Rostfreier Stahl	Impax und weitere Chrom-Nickel-Stähle	150

P.S.: Die genaue Schnittgeschwindigkeit hängt von der verwendeten Wendeschneidplatte ab. In Abhängigkeit vom Material wählen Sie die Schnittgeschwindigkeit vc. Diesen Wert multiplizieren Sie mit 1000 und teilen ihn durch 3,14 und den Durchmesser des Werkzeugs (in mm).

Beispiel: Rostfreier Stahl (Hauptgruppe 3), Werkzeugdurchmesser 25 mm, Schnittgeschwindigkeit vc=170 m/min. Die Berechnung sieht wie folgt aus:  $170 \times 1000 / 3,14 = 54140 / 25 = 2166$  U/min. (Spindeldrehzahl). Der Vorschub der Maschine hängt vom Vollbohrer und der verwendeten Wendeschneidplatte ab und variiert zwischen 0,05 mm und 0,1 mm / Umdrehung.

### VORSCHRUBBERECHNUNG :

Die oben berechnete Spindeldrehzahl von 2166 wird mit dem Vorschub 0,05 mm und 0,1 mm multipliziert.  $2166 \text{ Umdr./min.} \times 0,05 \text{ mm/Umdr.} = 108 \text{ mm/min.}$   $2166 \text{ Umdr./min.} \times 0,1 \text{ mm/Umdr.} = 216 \text{ mm/min.}$  D.h. der Vorschub liegt zwischen 108 mm/min. und 216 mm/min. Hinweis: Der Kühlmitteldruck muss mindestens 6 bar betragen für die Vollbohrer mit  $\geq 4 \times D$

## SIKMA TORKU TAVSİYELERİ - RECOMMENDED TIGHTENING TORQUE EMPFOHLENES ANZUGSMOMENT

- Takımı Sıkmadan Önce Aşağıdaki Bilgileri Okuyunuz.  
*Read below information before tightening the tool.*  
*Bitte lesen Sie die nachfolgenden Informationen bevor Sie das Werkzeug spannen.*
- Vidalı Takımın Vida Ölçüsü ile Tutucunun İç Vida Ölçüsünü Sıkmadan Önce Kontrol Ediniz.  
*Check screw set's the screw size and together with mounting arbor inner dimension of screws.*  
*Prüfen Sie, ob das Gewinde vom Werkzeug mit dem Gewinde in der Verlängerung identisch ist.*
- Takımı Tutucuya Sıkarken Tablodaki İlgili Değerlere Göre İşlem Yapınız.  
*When tightening head to an arbor, follow the related tightening torque in the table.*  
*Wenn Sie den Einschraubfräser festziehen, beachten Sie bitte die angegebenen Anzugsmomente.*

Vida Screw Schraube	Tork Torque (N.m) Anzugsmoment (N.m)
M6	8
M8	23
M10	46
M12	80
M16	90





## FREZELEME İŞLEMİNDE DEVİR ve İLERLEME HESABI

Vc.	S	D	F	Z	fz	FORMÜLLER
Kesme Hızı (Uç Kutusunun Arkasından Okuyunuz)	İş Mili Devir Sayısı	Tarama Kafası Çapı	İlerleme	Tarama Kafası Ağız Sayısı	Diş Başına Düşen İlerleme Miktarı (Uç Kutusunun Arkasından Okuyunuz)	Devir Hesabı : $S=(Vc \times 1000) / (3,14 \times D)$ İlerleme Hesabı : $F=S \times Z \times fz$

**Örnek :** D=50 mm çapında, Z=5 ağızlı tarama kafası ile frezeleme yapacağız. Kesici uç kutusunun arkasında kesme hızı Vc=200m/dk. olarak verilmiş olsun. Tezgaha girilecek devri hesaplayalım: **Vc=200 m/dk. D=50 mm S =** Öncelikle Kesme Hızı 1000 ile çarpılır, çıkan sonuç 3,14 sayısına bölünür, buradan çıkan sonuç da tarama kafası çapına bölünür.

$S=200 \times 1000 = 200000 \rightarrow 200000/3,14=63663 \rightarrow 63663/50=1273$  devir **S=1273 dev/dakika** deviri bulduktan sonra ilerlemeyi bulalım: **Z=5** ağızlı tarama kafası olsun **fz=0,12** olarak uç kutusunun arkasından okunmuş olsun F= yukarıda bulmuş olduğumuz devir sayısı ile ağız sayısı çarpılır, çıkan sonuç diş başına düşen ilerleme miktarı ile çarpılır.

$F=1273 \times 5 = 6365 \rightarrow 6365 \times 0,12 = 763$   $F=763$  mm/dakika

Tezgaha girilecek olan devir = S 1273 Tezgaha girilecek olan ilerleme : **F 763 ortalama değerdir.**

**Not:** Vc ve fz değerlerinin uç kutusunun arkasında verilmiş olması gerekir. Eğer bu değerler uç kutusunun üzerinde yoksa, kesici ucun katalogundan bulunuz. İşleyeceğiniz malzeme çelik ise P, paslanmaz çelik ise M, dökme demir ise K bölümünde yazılı olan Vc ve fz değerlerini okuyun.

## CALCULATING SPINDLE SPEED and FEED RATE FOR MILLING PROCESS

Vc.	S	D	F	Z	fz	FORMULAS
Cutting Speed (Please read from the back- side of cutting insert box)	Spindle Revolution rpm	Milling Tool Diameter	Feed Rate	Number of Effective Tooth	Feed Per Tooth (Please Read From The Back Side of Cutting Insert Box)	Calculation of Revolution : $S=(Vc \times 1000) / (3,14 \times D)$ Feed Rate Calculation : $F=S \times Z \times fz$

For Example : We will make milling with milling tool whose diameter is D 50 mm, whose teeth number is Z=5. The spindle revolution was written as Vc=200m/mn at the back side of cutting insert box. Let's calculate the revolution that should be entered to the milling machine : Vc=200 m/mn D=50 mm

S = Firstly Cutting Speed is multiplied with 1000, the result should be divided by 3.14 , the last result should be divided by diameter of milling tool.

$S = 200 \times 1000 = 200000 \rightarrow 200000/3,14 = 63663 \rightarrow 63663/50 = 1273$  rev  $S=1273$  rev / mn

After finding spindle revolution, let's find feed rate : milling tool with Z=5 teeth and we read fz=0,12 from the back side of cutting insert box.

F = Tooth number should be multiplied with revolution, the result should be multiplied with feed per tooth.

$F = 1273 \times 5 = 6365 \rightarrow 6365 \times 0,12 = 763$   $F = 763$  mm / mn

Revolution that should be entered to the milling machine = S 1273 Feed Rate that should be entered to the milling machine = F 763 average value.

P.S : The values Vc and fz has to be written at the back side of the cutting insert. If these values were not written on the cutting insert box, please find them from cutting insert catalogue. If the material that you will work is steel, please read Vc and fz values that were written on the part P, if it is stainless steel please read from the part M, if it is cast iron please read from the part K.

## BERECHNUNG VON DREHZAHL UND VORSCHUB FÜR FRÄSWERKZEUGE

Vc.	S	D	F	Z	fz	Formeln
Schnittgeschwindigkeit (finden Sie z.B. auf der Verpackung der Wendeschneidplatte)	Spindel Drehzahl	Fräswerkzeug Durchmesser	Vorschubgeschwindigkeit	Anzahl der effektiven Zähne	Vorschub pro Zahn (finden Sie z.B. auf der Verpackung der Wendeschneidplatte)	Berechnung der Drehzahl: $n=(vc \times 1000) / (3,14 \times D)$ Vorschubberechnung: $F=n \times Z \times fz$

Beispiel: Fräswerkzeug mit D=50 mm und Z=5. Schnittgeschwindigkeit vc=200 m/min. (laut Wendepplattenverpackung).

Berechnung der Drehzahl:  $n=200 \text{ m/min.} \times 1000 = 200000 / 3,14=63694 / 50 \text{ mm} = 1273$  Umdr./min.

Berechnung des Vorschubs: Ermittlung von fz (finden Sie z.B. auf der Verpackung der Wendeschneidplatte), für das Berechnungsbeispiel fz=0,12 mm  $F = n \times Z \times fz = 1273 \times 5 \times 0,12 = 763$  mm/min. D.h., Sie stellen an der Maschine folgende Werte ein: Drehzahl n = 1273 Umdr./min., Vorschub F = 763 mm/min.

P.S.: Die Werte für vc und fz finden Sie auf der Rückseite der Wendeschneidplattenverpackung. Sollten diese Werte dort nicht stehen, können Sie diese auch im Wendeschneidplattenkatalog finden. Für Stahl wählen Sie für vc und fz bitte die Werte aus dem Bereich P, für rostfreien Stahl aus dem Bereich M und für Guss aus dem Bereich K.

## Gövde Malzemesine Göre Delik İçi Kater Uygulama Kılavuzu

### Internal Boring Bars Application Guide, Related to Body Material

#### Anwendungshinweise für Bohrstangen, abhängig vom Bohrstangen-Material

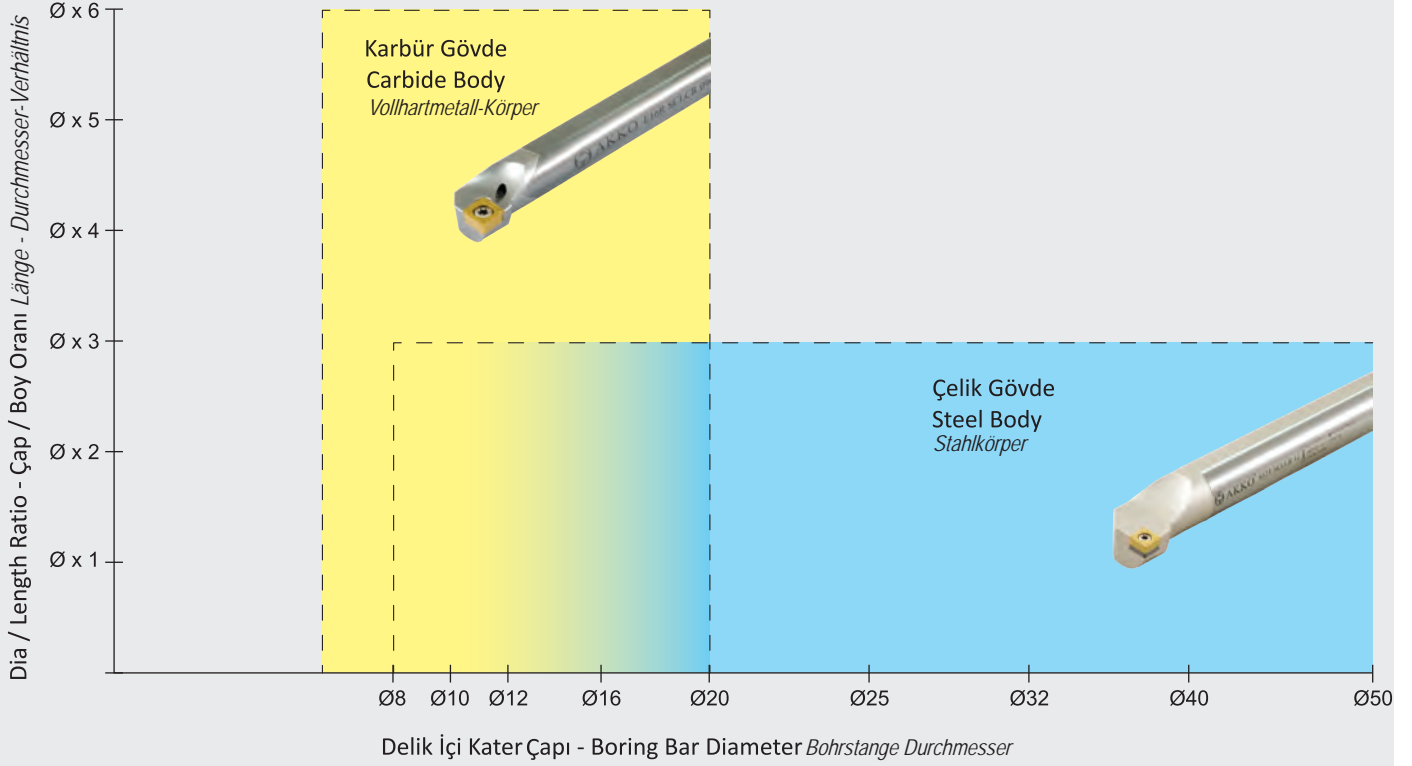

## T Kanal Freze Kullanım ve Ön Hazırlama Kılavuzu

### Application Guide For T-Slot Milling

#### Anwendungshinweise für T-Nutenfräser

T kanal frezelemede talaşın rahat boşaltılması için iş parçası resimde gösterildiği şekilde işlenmelidir.

Örnek: ATSM90-CC06- D32X10-W25- L100-Z04 kodlu T freze ile kanal açmadan önce, takımın boğazının çalışacağı kısmın parmak freze ile işlenmesi gerekir. Bu durumda kanalın tamamen işlenmesi çok yanlıştır. Tabanda ( $0.8 \times b = 0.8 \times 10$ ) 8mm işlenmeden bırakılmalıdır. Bu bölgeyi T frezinin işlemesi, takımın daha sağlıklı çalışması açısından gereklidir.

İşlenen kanallarda yumuşak kesim için talaşlar uzaklaştırılmış olmalıdır.

When T slot machining steel, the workpiece must be machined as shown in the drawing to ensure smooth chip evacuation.

Example: Before slotting with the T - slot milling cutter - code ATSM90-CC06-D32X10-W25-L100-Z04,

The area of the neck of the tools to be worked and must be machined by End-Mill.

In this case, it is very wrong to machining the slot completely.

Bottom area ( $0.8 \times b = 0.8 \times 10$ ) should be left 8 mm without machining.

This area's operation must be machined by the T - slot milling cutter which is also necessary for the healthier work of the tool holder.

Slots to be machined must be free from chips for smooth machining.

Beim Einsatz von T-Nutenfräsern muss das Werkstück so bearbeitet werden wie es in der Zeichnung dargestellt ist, um einen problemlosen Spänetransport zu gewährleisten.

Beispiel: Einsatz des T-Nutenfräasers ATSM90-CC06-D32X10-W25-L100-Z04

Die Aussparung für den Halsbereich des T-Nutenfräasers muss mit einem Schafffräser vorgearbeitet werden. Bitte beachten Sie dabei, dass die Aussparung nicht komplett bis auf den Grund gefräst wird, sondern eine Bodenstärke von  $0,8 \times b$  (im Beispiel  $0,8 \times 10 \text{ mm} = 8 \text{ mm}$ ) im Werkstück verbleibt.

Dieser Bereich soll mit dem T-Nutenfräser bearbeitet werden, da dies für die Stabilität und Standzeit des Werkzeugs besser ist.

In der zu bearbeitenden Nut sollten keine Späne mehr vorhanden sei.

### KULLANIM İÇİN UYARI

#### CAUTION FOR USE

Bitte beachten Sie!

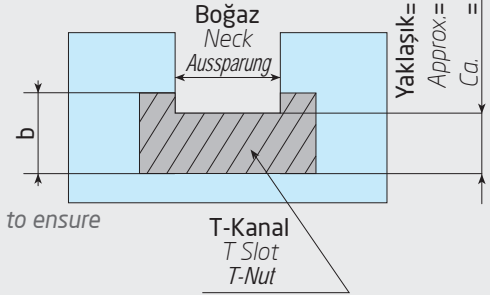

**α = 5 Kat Dayanıklılık****α = 5 Times Long Life****α = 5-Fache Standzeit**

## Alfa Kaplamanın Avantajları

Alpha Coating  
Advantages

Vorteile der  
Alpha-Beschichtung

- **Yüksek aşınma direnci**  
High resistance to abrasion  
Hoher Verschleißschutz
- **Yüksek yüzey sertliği**  
**750-800 Vickers**  
High surface hardness  
750-800 Vickers  
Hohe Oberflächenhärte von  
750-800 HV
- **Temperlemeye karşı yüksek direnç**  
High resistance to tempering  
Hoher Temperaturwiderstand
- **Yüksek yorulma mukavemeti**  
High fatigue strength  
Hohe Dauerfestigkeit
- **Yüksek çizik ve çentik direnci**  
High scratch and impact resistance  
Hoher Kratz- und Stoß-Widerstand
- **Paslanmaz olmayan çelikler için daha yüksek korozyon direnci**  
Resistant to corrosion of  
non-stainless steel  
Korrosionsschutz

takımınız neden  
**daha uzun ömürlü**  
olmasın? ...

**longer tool life...**

**längere Werkzeug-Standzeit**



**α Çevre Dostudur. α is eco friendly.**  
**α ist umweltfreundlich.**

**İnsan sağlığı açısından zararlı değildir. Is not harmful to human health.**  
**Nicht gesundheitsschädlich.**

**Gaz ve diğer atıkları çevreyi kirletmez. Gas and other wastes will not pollute the environment.**  
**Umweltverträgliches Beschichtungsverfahren.**



ALTLIKLAR / SHIMS / UNTERLAGE

ÜRÜN RESMİ/PICTURE BILD	ÜRÜN KODU/CODE BEZEICHNUNG	ÜRÜN DETAYI / PRODUCT DETAIL PRODUKTBESCHREIBUNG	
	<b>AATN-2-0001</b>	S-SİSTEM için / For S-SYSTEM / FÜR S-SYSTEM	
	<b>AATN-2-0002</b>	T-M SİSTEM için / For T-M SYSTEM / FÜR T-M-SYSTEM	
	<b>AATN-3-0025</b>	P-SİSTEM için / For P-SYSTEM / FÜR P-SYSTEM	
	<b>AATN-3-0015</b>	T-M-P SİSTEM için / For T-M SYSTEM / FÜR T-M-P-SYSTEM	
	<b>AATN-2-0020</b>	DİŞ VİDA 16 ALTLIK / For THREADING 16 SHIM / GEWINDE 16 UNTERLAGE	
	<b>AATN-2-0004</b>	DİŞ VİDA 22 ALTLIK / For THREADING 22 SHIM / GEWINDE 22 UNTERLAGE	
	<b>ATS-16E</b>	DİŞ VİDA 16, DİŞ ÇAP SAĞ - DELİK İÇİ SOL ALTLIK / For THREADING SYSTEM 16 SHIM, EXTERNAL RIGHT-INTERNAL LEFT / FÜR 16 ER-GEWINDEPLATTE, EXTERN RECHTS - INTERN LINKS	
	<b>ATS-16I</b>	DİŞ VİDA 16, DİŞ ÇAP SOL - DELİK İÇİ SAĞ ALTLIK / For THREADING SYSTEM 16 SHIM, EXTERNAL LEFT-INTERNAL RIGHT / FÜR 16 ER-GEWINDEPLATTE, EXTERN LINKS - INTERN RECHTS	
	<b>ATS-22E</b>	DİŞ VİDA 22, DİŞ ÇAP SAĞ - DELİK İÇİ SOL ALTLIK / For THREADING SYSTEM 22 SHIM, EXTERNAL RIGHT-INTERNAL LEFT / FÜR 22 ER-GEWINDEPLATTE, EXTERN RECHTS - INTERN LINKS	
	<b>ATS-22I</b>	DİŞ VİDA 22, DİŞ ÇAP SOL - DELİK İÇİ SAĞ ALTLIK / For THREADING SYSTEM 22 SHIM, EXTERNAL LEFT-INTERNAL RIGHT / FÜR 22 ER-GEWINDEPLATTE, EXTERN LINKS - INTERN RECHTS	
	<b>ATS-27E</b>	DİŞ VİDA 27, DİŞ ÇAP SAĞ - DELİK İÇİ SOL ALTLIK / For THREADING SYSTEM 27 SHIM, EXTERNAL RIGHT-INTERNAL LEFT / FÜR 27 ER-GEWINDEPLATTE, EXTERN RECHTS - INTERN LINKS	
	<b>ATS-27I</b>	DİŞ VİDA 27, DİŞ ÇAP SOL - DELİK İÇİ SAĞ ALTLIK / For THREADING SYSTEM 27 SHIM, EXTERNAL LEFT-INTERNAL RIGHT / FÜR 27 ER-GEWINDEPLATTE, EXTERN LINKS - INTERN RECHTS	
	<b>AACN-2-0001</b>	S-SİSTEM için / For S-SYSTEM / FÜR S-SYSTEM	
	<b>AACN-2-0002</b>	T-SİSTEM için / For T-SYSTEM / FÜR T-T-SYSTEM	
	<b>AACN-2-0003</b>	P-SİSTEM için / For P-SYSTEM / FÜR P-SYSTEM	
	<b>AACN-3-0001</b>	T-M-P SİSTEM için / For T-M-P SYSTEM / FÜR T-M-P-SYSTEM	
	<b>AACN-3-0002</b>	T-P SİSTEM için / For T-P SYSTEM / FÜR T-P-SYSTEM	
	<b>AACN-3-0003</b>	T-P SİSTEM için / For T-P SYSTEM / FÜR T-P-SYSTEM	
	<b>AACN-3-0008</b>	T-P SİSTEM için / For T-P SYSTEM / FÜR T-P-SYSTEM	
	<b>AACN-3-0003</b>	C-SİSTEM için / For C-SYSTEM / FÜR C-SYSTEM	
	<b>AAWN-2-0003</b>	T-M-P SİSTEM için / For T-M-P SYSTEM / FÜR T-M-P-SYSTEM	
	<b>AAWN-3-0001</b>	T-M-P SİSTEM için / For T-M-P SYSTEM / FÜR T-M-P-SYSTEM	
	<b>AAWN-SW317</b>	T-M-P SİSTEM için / For T-M-P SYSTEM / FÜR T-M-P-SYSTEM	
	<b>AKS-16L</b>	C-SİSTEM için / For C-SYSTEM / FÜR C-SYSTEM	
	<b>AKS-16R</b>	C-SİSTEM için / For C-SYSTEM / FÜR C-SYSTEM	
	<b>AASD-3-0001</b>	S-SİSTEM FREZELEME için / For S-SYSTEM MILLING / S-SYSTEM FÜR FRÄSER	
	<b>AASE-3-0001</b>	S-SİSTEM FREZELEME için / For S-SYSTEM MILLING / S-SYSTEM FÜR FRÄSER	
	<b>AASN-2-0001</b>	S-SİSTEM için / For S-SYSTEM / FÜR S-SYSTEM	
	<b>AASN-2-0002</b>	P-SİSTEM için / For P-SYSTEM / FÜR P-SYSTEM	
	<b>AASN-2-0004</b>	S-SİSTEM için / For S-SYSTEM / FÜR S-SYSTEM	
	<b>AASN-3-0004</b>	T-P SİSTEM için / For T-P SYSTEM / FÜR T-P-SYSTEM	
	<b>AASN-3-0023</b>	C-SİSTEM için / For C-SYSTEM / FÜR C-SYSTEM	
	<b>AASN-3-0023</b>	T-P SİSTEM için / For T-P SYSTEM / FÜR T-P-SYSTEM	
	<b>AASN-3-0005</b>	T-P SİSTEM için / For T-P SYSTEM / FÜR T-P-SYSTEM	
	<b>AASN-3-0020</b>	T-P SİSTEM için / For T-P SYSTEM / FÜR T-P-SYSTEM	
	<b>AASN-20020</b>	PSDNN KARTUŞ için / For PSDNN CARTRIDGE / FÜR PSDNN-KURZDREHHALTER	
		<b>AADN-2-0001</b>	S-SİSTEM için / For S-SYSTEM / FÜR S-SYSTEM
		<b>AADN-SD317</b>	T-SİSTEM için / For T-SYSTEM / FÜR T-SYSTEM
		<b>AADN-3-0001</b>	P-SİSTEM için / For P-SYSTEM / FÜR P-SYSTEM
<b>AADN-2-0003</b>		T-M-P SİSTEM için / For T-M-P SYSTEM / FÜR T-M-P-SYSTEM	
	<b>AAVN-2-0002</b>	C-SİSTEM için / For C-SYSTEM / FÜR C-SYSTEM	
	<b>AAVN-2-0003</b>	T-SİSTEM için / For T-SYSTEM / FÜR T-SYSTEM	
	<b>AAVN-2-0003</b>	S-SİSTEM için / For S-SYSTEM / FÜR S-SYSTEM	
	<b>AARC-3-0001</b>	T-SİSTEM için / For T-SYSTEM / FÜR T-SYSTEM	
	<b>AARC-3-0002</b>	S-SİSTEM için / For S-SYSTEM / FÜR S-SYSTEM	
	<b>AARC-3-0003</b>	C-SİSTEM için / For C-SYSTEM / FÜR C-SYSTEM	



BASKI PABUÇLARI / CLAMPS / SPANNSPRATZE

ÜRÜN RESMİ/PICTURE BILD	ÜRÜN KODU/CODE BEZEICHNUNG	ÜRÜN DETAYI / PRODUCT DETAIL PRODUKTBESCHREIBUNG
	<b>ATK-01</b>	T-SİSTEM için / For T-SYSTEM / FÜR T-SYSTEM DNMG 11, WNMG 06, TNMG 16, CNMG 09 BASKI PABUCU / CLAMP / PRATZE
	<b>ATK-02</b>	T-SİSTEM için / For T-SYSTEM / FÜR T-SYSTEM CNMG 12, WNMG 08, TNMG 22, DNMG 15, SNMG 12 BASKI PABUCU / CLAMP / PRATZE
	<b>ATK-03</b>	T-SİSTEM için / For T-SYSTEM / FÜR T-SYSTEM VNMG 16 BASKI PABUCU / CLAMP / PRATZE
	<b>ATK-04</b>	T-SİSTEM için / For T-SYSTEM / FÜR T-SYSTEM CNMG 16, SNMG 15 BASKI PABUCU / CLAMP / PRATZE
	<b>ATKH-01-R</b>	T-SİSTEM için / For T-SYSTEM / FÜR T-SYSTEM İÇTEN SOĞUTMA KANALLI BASKI PABUCU / WITH COOLANT TOOLS / MIT INNENKÜHLUNG
	<b>ATKH-02-L</b>	T-SİSTEM için / For T-SYSTEM / FÜR T-SYSTEM İÇTEN SOĞUTMA KANALLI BASKI PABUCU / WITH COOLANT TOOLS / MIT INNENKÜHLUNG
	<b>AMK-01</b>	M-SİSTEM için / For M-SYSTEM / FÜR M-SYSTEM WNMG 06 BASKI PABUCU / CLAMP / PRATZE
	<b>AMK-02</b>	M-SİSTEM için / For M-SYSTEM / FÜR M-SYSTEM DELİK İÇİ / INTERN / INNEN Ø20 TNMG 16, Ø25 MT-NR/L 16 BASKI PABUCU / CLAMP / PRATZE
	<b>AMK-03</b>	M-SİSTEM için / For M-SYSTEM / FÜR M-SYSTEM DNMG 11, CNMG 12 BASKI PABUCU / CLAMP / PRATZE
	<b>AMK-04</b>	M-SİSTEM için / For M-SYSTEM / FÜR M-SYSTEM DNMG 15, TNMG 16-22 BASKI PABUCU / CLAMP / PRATZE
	<b>AMK-05</b>	M-SİSTEM için / For M-SYSTEM / FÜR M-SYSTEM WNMG 08 BASKI PABUCU / CLAMP / PRATZE
	<b>AMK-07</b>	M-SİSTEM için / For M-SYSTEM / FÜR M-SYSTEM S20R MCLNR/L BASKI PABUCU / CLAMP / PRATZE
	<b>AMK-08</b>	M-SİSTEM için / For M-SYSTEM / FÜR M-SYSTEM TNMG 22 BASKI PABUCU / CLAMP / PRATZE
	<b>ACK-01-R</b>	C-SİSTEM için / For C-SYSTEM / FÜR C-SYSTEM KNUX-R BASKI PABUCU / CLAMP / PRATZE
	<b>ACK-02-L</b>	C-SİSTEM için / For C-SYSTEM / FÜR C-SYSTEM KNUX-L BASKI PABUCU / CLAMP / PRATZE
	<b>ACK-03</b>	C-SİSTEM için / For C-SYSTEM / FÜR C-SYSTEM 154.91 DIŞ ÇAP ve DELİK İÇİ/EXTERNAL and INTERNAL/ AUßEN-DREHHALTER Ø25-Ø32 / PABUCU / CLAMP / PRATZE
	<b>ACK-04</b>	P-C-SİSTEM için / For P-C-SYSTEM / FÜR P-C-SYSTEM CTFPR KARTUŞ BASKI PABUCU / CARTRIDGE CLAMP / PRATZE FÜR KASSETTE
	<b>ACK-05</b>	P-C-SİSTEM için / For P-C-SYSTEM / FÜR P-C-SYSTEM FREZELEME ve DIŞ VİDA AÇMA TAKIMLARINA GÖRE İLAVE BASKI PABUCU ADDITIONAL LITTLE CLAMP for MILLING and THREADING CLAMP KLEINE ZUSATZKLEMME FÜR FRÄSER UND GEWINDEWERKZEUGE
	<b>ACK-06</b>	C-SİSTEM için / For C-SYSTEM / FÜR C-SYSTEM 154.91 DELİK İÇİ / INTERNAL / INNEN Ø16-Ø20 BASKI PABUCU / CLAMP / PRATZE
	<b>ACK-07</b>	C-SİSTEM için / For C-SYSTEM / FÜR C-SYSTEM SERAMİK CNGN, SNGN, DNGN YEDEK TAKIMI SPARE PART SET of CERAMIC CNGN, SNGN, DNGN ERSATZTEILSATZ FÜR KERAMIKCNGN, SNGN, DNGN
	<b>ACK-08</b>	C-SİSTEM için / For C-SYSTEM / FÜR C-SYSTEM SERAMİK TNGN, YEDEK TAKIMI SPARE PART SET of CERAMIC TNGN ERSATZTEILSATZ FÜR KERAMIK TNGN
	<b>ACK-09</b>	P-SİSTEM için / For P-SYSTEM / FÜR P-SYSTEM CNMG 16-19, SNMG 15-19 İLAVE BÜYÜK BASKI PABUCU ADDITIONAL BIG CLAMP / ZUSÄTZLICHE GROSSE KLEMME
	<b>ACK-10</b>	C-SİSTEM FREZELEME için / For C-SYSTEM MILLING C-SYSTEM FÜR FRÄSER SPKN 12, Ø50-Ø63 TPKN 16 BASKI PABUCU / CLAMP / PRATZE (M8x8)
	<b>ACK-11</b>	C-SİSTEM FREZELEME için / For C-SYSTEM MILLING C-SYSTEM FÜR FRÄSER Ø80-Ø100 TPKN 16-TPKN 22, OFKR 07, HNMX 09 BASKI PABUCU / CLAMP / PRATZE (M8x10)
	<b>ACK-12</b>	C-SİSTEM için / For C-SYSTEM / FÜR C-SYSTEM CTSPR KARTUŞ BASKI PABUCU / CARTRIDGE CLAMP PRATZE FÜR KASSETTE
	<b>ACK-15</b>	S-SİSTEM FREZELEME için / For S-SYSTEM MILLING S-SYSTEM FÜR FRÄSER RD.. 10-12 BASKI PABUCU / CLAMP / PRATZE
	<b>ACK-19</b>	S-SİSTEM FREZELEME için / For S-SYSTEM MILLING S-SYSTEM FÜR FRÄSER WD0805D BASKI PABUCU / CLAMP / PRATZE
	<b>ACK-21</b>	C-SİSTEM için / For C-SYSTEM / FÜR C-SYSTEM SN.. 1204.. BASKI PABUCU / CLAMP / PRATZE
	<b>ACK-23</b>	C-SİSTEM için / For C-SYSTEM / FÜR C-SYSTEM SERAMİK DNGN 11, YEDEK TAKIMI SPARE PART SET of CERAMIC DNGN 11 ERSATZTEILSATZ FÜR KERAMIK DNGN 11
	<b>ACK-24</b>	S-SİSTEM FREZELEME için / For S-SYSTEM MILLING S-SYSTEM FÜR FRÄSER XD0806D BASKI PABUCU / CLAMP / PRATZE
	<b>ACK-26</b>	C-SİSTEM için / For C-SYSTEM / FÜR C-SYSTEM XNMM 0806.. BASKI PABUCU / CLAMP / PRATZE
	<b>ACK-27</b>	C-SİSTEM için / For C-SYSTEM / FÜR C-SYSTEM RCGX 06 BASKI PABUCU / CLAMP / PRATZE
	<b>ACK-28</b>	C-SİSTEM için / For C-SYSTEM / FÜR C-SYSTEM RCGX 09 BASKI PABUCU / CLAMP / PRATZE
	<b>ACK-29</b>	C-SİSTEM için / For C-SYSTEM / FÜR C-SYSTEM RCGX 12 BASKI PABUCU / CLAMP / PRATZE

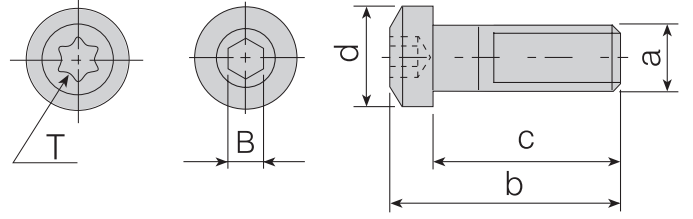

BASKI PABUÇ VIDALARI / CLAMP SCREWS / SCHRAUBEN FÜR PRATZEN

Takım Kodu Ordering Code Bestell-Bezeichnung	a (M)	b	c	d	B(T)	Ürün Detayı / Product Detail / Produkt-Details
AKV-01-M5X22	M5x0.8	25.1	22	11	3	T-SİSTEM için / For T-SYSTEM / FÜR T-SYSTEM DNMG 11, WNMG 06, TNMG 16
AKV-02-M6X22	M6x1.0	25.3	22	11	3	T-SİSTEM için / For T-SYSTEM / FÜR T-SYSTEM CNMG 12, WNMG 08, TNMG 22, DNMG 15, SNMG 12, VNMG 16
						M-SİSTEM için / For M-SYSTEM / FÜR M-SYSTEM TNMG 16, TNMG 22
AKV-03-M6X22	M6x1.0	25.3	22	10	3	M-SİSTEM için / For M-SYSTEM / FÜR M-SYSTEM WNMG 08
						KANAL KATERİ için / For EXTERNAL GROOVING 2mm Dış Çap Kanal Kater Vidası / External Grooving Tools Screw FÜR STECHWERKZEUGE 2 mm Schraube für Außen-Steckwerkzeuge
AKV-04-M5X17	M5x0.8	20	17	8.5	3	M-SİSTEM için / For M-SYSTEM / FÜR M-SYSTEM S20R MT-NR/L 16, S20R-S25S MWLNR/L 06, S25S MDUNR/L 11-Dış Çap / External / AUßEN MWLNR 06
AKV-05-M6X25	M6x1.0	29.5	25	13.8	4	T-SİSTEM için / For T-SYSTEM / FÜR T-SYSTEM Eski Ürün Vidası / Old Products Screws / Schraube für alles Produkt CNMG 16, SNMG 15
AKV-06-M6X20	M6x1.0	26.5	20	10.6	4	C-SİSTEM için / For C-SYSTEM / FÜR C-SYSTEM KNUX 16
AKV-07-M6X22	M6x1.0	23.5	22	8.5	3	C-SİSTEM için / For C-SYSTEM / FÜR C-SYSTEM ADKT-154.91, AIKT-154.91-R/L-32
AKV-10-M6X14	M6x1.0	16	14	8.8	4	C-SİSTEM için / For C-SYSTEM / FÜR C-SYSTEM AIKT-154.91-R/L-16, AIKT-154.91-R/L-20, AIKT-154.91-R/L-25
AKV-11-M8X29	M8X1.25	33.6	29	11	4	C-SİSTEM için / For C-SYSTEM / FÜR C-SYSTEM TNGN 16, CNGN 12, DNGN 15, SNGN 12
AKV-17-M5X15	M5X0.8	18	15	8.55	3	M-SİSTEM için / For M-SYSTEM / FÜR M-SYSTEM S16P MWLNR/L 06
AKV-19-M7X25	M7X1.0	29.6	25	14	4	T-SİSTEM için / For T-SYSTEM / FÜR T-SYSTEM Yeni / New / Neu CNMG 16, SNMG 15
AKV-20-M6X19	M6x1.0	22	19	11	3	M-SİSTEM için / For M-SYSTEM / FÜR M-SYSTEM S25S MDUNR/L 15
AKV-21-M6X18	M6x1.0	20	18	8.5	3	C-SİSTEM için / For C-SYSTEM / FÜR C-SYSTEM AIKT-154.91-R/L-25
AKV-23-M4X10	M4x0.7	12.2	10	7.4	15	KARTUŞ için / For CARTRIDGE / FÜR KASSETTE Montaj Vidası / Mounting Screw / Befestigungsschraube
AKV-27-M6X20	M6x1.0	23.3	20	10	3	M-SİSTEM için / For M-SYSTEM / FÜR M-SYSTEM S25S MWLNR/L 08
AKV-30-M6X22	M6x1.0	25.3	22	11	3	T-SİSTEM için / For T-SYSTEM / FÜR T-SYSTEM Baskı Pabucu / Wedge Clamp / Spannpratze
AKV-33-M6X22	M6x1.0	25.3	22	9.5	3	T-SİSTEM için / For T-SYSTEM / FÜR T-SYSTEM Baskı Pabucu / Wedge Clamp / Spannpratze

SOĞUTMA NOZULU / COOLANT NOZZLE / KÜHLMITTELDÜSE

Ürün Resmi Product Picture Produkt-Bild	Ürün Kodu Product Code / Code	Ürün Detayı / Product Detail / Produkt-Details
	AN-01	SOĞUTMA NOZULU / Coolant Nozzle / KÜHLMITTELDÜSE
		SOĞUTMA NOZULU / Coolant Nozzle / KÜHLMITTELDÜSE

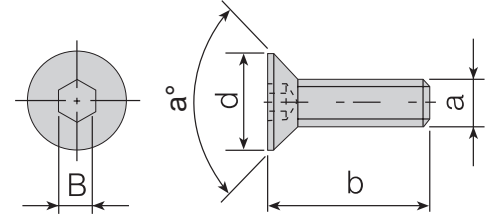

ALTLIK VİDALARI / SHIM SCREWS / SCHRAUBE FÜR UNTERLAGE						
Takım Kodu Ordering Code Bestell-Bezeichnung	a (M)	b	d	B	a°	Ürün Detayı / Product Detail / Produkt-Details
AAV-01-M3x10	M3X0.5	10	5.9	2	90°	T-SİSTEM için / For T-SYSTEM / FÜR T-SYSTEM WNMG 06, KNUX 16
AAV-02-M5X12	M5X0.8	12	7	3	56°	T-SİSTEM için / For T-SYSTEM / FÜR T-SYSTEM CNMG 12, WNMG 08, TNMG 22, DNMG 15, SNMG 12
AAV-05-M6X15	M6X1.0	15	9	4	60°	T-SİSTEM için / For T-SYSTEM / FÜR T-SYSTEM CNMG 16, SNMG 15
AKV-12-M5X12	M5X0.8	12	7.8	3	90°	C-SİSTEM için / For C-SYSTEM / FÜR C-SYSTEM CTSPR Baskı Pabuç Vidası / Clamp Screw / Klemmschraube
AKV-16-M6X16	M6X1.0	16	10	4	76°	C-SİSTEM için / For C-SYSTEM / FÜR C-SYSTEM CTFPR 13CS 16 Baskı Pabuç Vidası / Clamp Screw / Klemmschraube
AAV-13-M5X8	M5X0.8	8	7	3	56°	T-SİSTEM için / For T-SYSTEM / FÜR T-SYSTEM S25S TSKNR/L 12, S25S TCLNR/L 12, S25S TWLNR/L 08, S25S TDUNR/L 15
AAV-14-M5X14	M5X0.8	14	8.8	3	45°	ADCR için / For ADCR / FÜR ADCR ADCR Montaj Vidası / Mounting Screw / ADCR BEFESTIGUNGSSCHRAUBE

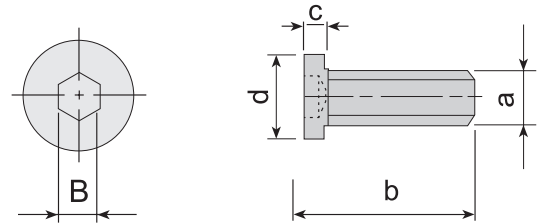

ALTLIK VİDALARI / SHIM SCREWS / SCHRAUBE FÜR UNTERLAGE						
Takım Kodu Ordering Code Bestell-Bezeichnung	a (M)	b	c	d	B	Ürün Detayı / Product Detail / Produkt-Details
AAV-03-M5X12	M5X0.8	12	1.4	6	3	T-SİSTEM için / For T-SYSTEM / FÜR T-SYSTEM CNMG 16 TNGN 16
AAV-04-M5X12	M5X0.8	12	1.2	6.5	3	T-SİSTEM için / For T-SYSTEM / FÜR T-SYSTEM VNMG 16, DNMG 11, CNMG 09
AAV-09-M5X9	M5X0.8	9	1.4	6	3	T-SİSTEM için / For T-SYSTEM / FÜR T-SYSTEM S25S TCLNR/L 09, S25S TDUNR/L 11, S25S TDQNR/L 11

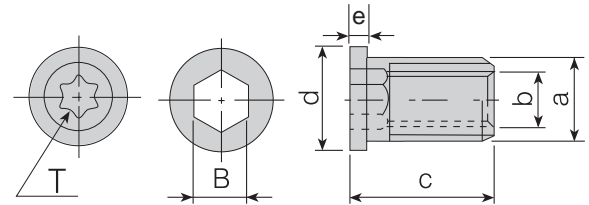

BUKSE VİDALAR / BUKSE SCREWS / SCHRAUBE FÜR UNTERLAGE							
Takım Kodu Ordering Code Bestell-Bezeichnung	a (M)	b	c	d	B(T)	e	Ürün Detayı / Product Detail / Produkt-Details
AAV-06-M3.5X11	M5x0.5	M3.5x0.6	11.3	6	3.5	1.2	S-SİSTEM için / For S-SYSTEM / FÜR S-SYSTEM CCMT 09, DCMT 11, VBMT 16, VCMT 16, TCMT 16, SCMT 09, 16 ER/L, 16 IR/L
AAV-07-M4.5X13	M6X0.75	M4.5X0.75	13	7.5	4.5	1.6	S-SİSTEM için / For S-SYSTEM / FÜR S-SYSTEM CCMT 12, SCMT 12, 22 ER/L, 22 IR/L
AAV-08-M3.5X8	M5X0.5	M3.5x0.6	8	6	20	1.2	S-SİSTEM için / For S-SYSTEM / FÜR S-SYSTEM Ø25 DCMT 11, Ø25-Ø32 CCMT 09, Ø25 TCMT 16, S25S-S32T SVJBR/L 16,
AAV-10-M4.5X8	M6X0.75	M4.5X0.75	8	7.5	4.5	1.05	S-SİSTEM için / For S-SYSTEM / FÜR S-SYSTEM Ø25-Ø32 CCMT 12, Ø25-Ø32 SCMT 12, SSDCN 1616 H12, SSSCR/L 1616 H12, SIR/L S25R 22
AAV-16-M3.5X8	M5X0.5	M3.5x0.6	8	6	20	1.1	S-SİSTEM için / For S-SYSTEM / FÜR S-SYSTEM SEMT 13

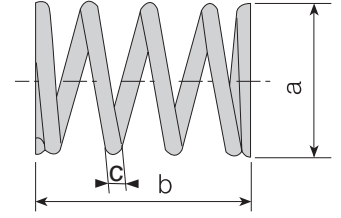
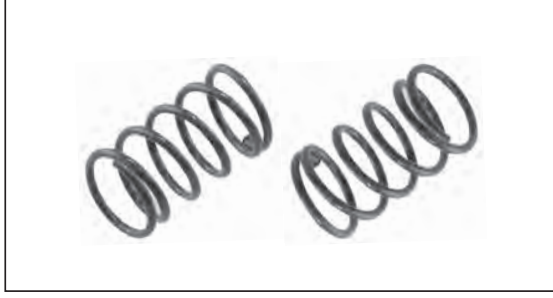

BASKI YAYI / CLAMP SPRING / FEDER FÜR KLEMME

Takım Kodu Ordering Code Bestell-Bezeichnung	a	b	c	Ürün Detayı / Product Detail / Produkt-Details	
AKY-01	7.7	11.2	0.9	T-SİSTEM için / For T-SYSTEM / FÜR T-SYSTEM	CNMG 12, WNMG 08, TNMG 22, DNMG 15, SNMG 12, VNMG 16
AKY-02	8.5	13.5	0.7	C-SİSTEM için / For C-SYSTEM / FÜR C-SYSTEM	KNUX 16

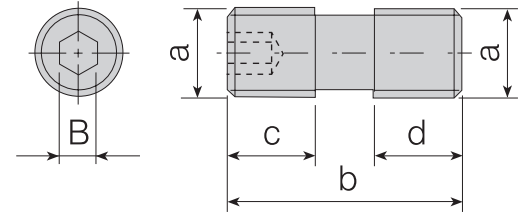

BASKI PABUÇ VIDALARI / CLAMP SCREWS / SCHRAUBEN FÜR PRATZEN

Takım Kodu Ordering Code Bestell-Bezeichnung	a (M)	b	c	d	B	Ürün Detayı / Product Detail / Produkt-Details	
AKV-13-M8X1X16	M8x1.0	16	6.8	6.8	4	C-SİSTEM FREZELEME için / MILLING For C- SYSTEM / C-SYSTEM FÜR FRÄSER	SPKN 12, Ø63 TPKN 16
AKV-14-M8X1X18	M8x1.0	18	8	8	4	C-SİSTEM FREZELEME için / MILLING For C- SYSTEM / C-SYSTEM FÜR FRÄSER	Ø80-Ø100 TPKN 16, Ø63-Ø315 TPKN 22
AKV-15-M8X1X20	M8x1.0	20	8.5	8.5	4	C-SİSTEM FREZELEME için / MILLING For C- SYSTEM / C-SYSTEM FÜR FRÄSER	OFKR 07, HNMX 09
AKV-18-M5X14	M5X0.8	15	5	6.8	2.5	C-SİSTEM FREZELEME için / MILLING For C- SYSTEM / C-SYSTEM FÜR FRÄSER	SN19
AKV-22-M8X1X14	M8x1.0	14	6.8	4.8	4	C-SİSTEM FREZELEME için / MILLING For C- SYSTEM / C-SYSTEM FÜR FRÄSER	Ø50 TPKN 16
AKV-24-M6X1X18	M6x1.0	18	7.5	7.5	3	C-SİSTEM FREZELEME için / MILLING For C- SYSTEM / C-SYSTEM FÜR FRÄSER	SN.. 1204
AKV-26-M6X0.75X20	M6x0.75	20	8.5	8.5	3	C-SİSTEM FREZELEME için / MILLING For C- SYSTEM / C-SYSTEM FÜR FRÄSER	AFM45C-XN0806
AKV-28-M10x1.5x43	M10x1.5	43	18	18	5	WNMU 0907.. Ø50 MONTAJ VIDASI / MOUNTING SCREW / BEFESTIGUNGSSCHRAUBE	WNMU 0907.. Ø50



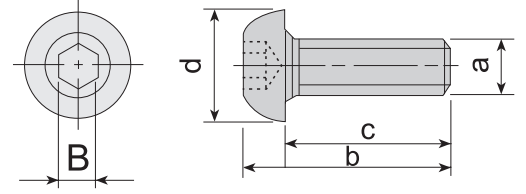

Takım Kodu  
Ordering Code  
Bestell-Bezeichnung

KANAL KATER ve MANTAR VİDALAR / GROOVING TOOL and CLAMP SCREWS / KLEMMSCHRAUBEN

	a (M)	b	c	d	B	Ürün Detayı / Product Detail / Produkt-Details
<b>1904-M8X1X20</b>	M8X1.0	25.9	20	11.3	4	S-SİSTEM için / For S-SYSTEM / FÜR S-SYSTEM RCMT 32 Sıkma Vidası / Clamp Screw / Klemmschraube
<b>2004-M8X1X20</b>	M8X1.0	25.9	20	11.4	4	KANAL KATERİ için / For EXTERNAL GROOVING / FÜR TMG-16, TMG-22 BOHRSTANGE Kanal Kater Vidası / External Grooving Tools Screw / SCHRAUBEN FÜR STECHHALTER
<b>2004-M8X20</b>	M8X1.25	30	25	25	4	KANAL KATERİ için / For EXTERNAL GROOVING / FÜR TMG-16, TMG-22 BOHRSTANGE Eski Kanal Kater Vidası / Old External Grooving Tools Screw Alte / Schraube für Stechhalter
<b>AKV-08-M6X12</b>	M6x1.0	17	12	14.3	4	C-SİSTEM FREZELEME için / MILLING For C-SYSTEM / C-SYSTEM FÜR FRÄSER Baskı ve Sıkma Vidası, Mantar Vida / Clamp Screw / Klemmschraube
<b>AKV-09-M8X18</b>	M8X1.0	24	18	17.2	5	C-SİSTEM FREZELEME için / MILLING For C-SYSTEM / C-SYSTEM FÜR FRÄSER Baskı ve Sıkma Vidası, Mantar Vida / Clamp Screw / Klemmschraube

Ürün Resmi  
Product Picture  
Produkt-Bild

LEVYELER / LEVERS / KNIEHEBEL

Ürün Kodu Product Code / Code	Ürün Detayı / Product Detail / Produkt-Details
<b>APL-01</b>	P-SİSTEM için / For P-SYSTEM / FÜR P-SYSTEM CNMG 09, DNMG 11, SNMG 09, TNMG 16, WNMG 06 LEVYESİ / LEVER / KNIEHEBEL
<b>APL-02</b>	P-SİSTEM için / For P-SYSTEM / FÜR P-SYSTEM CNMG 12, SNMG 12, TNMG 22, WNMG 08 LEVYESİ / LEVER / KNIEHEBEL
<b>APL-03</b>	P-SİSTEM için / For P-SYSTEM / FÜR P-SYSTEM DNMG 15 LEVYESİ / LEVER / KNIEHEBEL
<b>APL-04</b>	P-SİSTEM için / For P-SYSTEM / FÜR P-SYSTEM CNMG 16, SNMG 15 LEVYESİ / LEVER / KNIEHEBEL
<b>APL-05</b>	P-SİSTEM için / For P-SYSTEM / FÜR P-SYSTEM CNMG 19, SNMG 19 LEVYESİ / LEVER / KNIEHEBEL
<b>APL-06</b>	P-SİSTEM için / For P-SYSTEM / FÜR P-SYSTEM CNMG 25, SNMG 25 LEVYESİ / LEVER / KNIEHEBEL
<b>APL-07</b>	P-SİSTEM için / For P-SYSTEM / FÜR P-SYSTEM S16P PCLNR/L 09 LEVYESİ / LEVER / KNIEHEBEL
<b>APL-08</b>	P-SİSTEM için / For P-SYSTEM / FÜR P-SYSTEM S16P PTUNR/L 16 LEVYESİ / LEVER / KNIEHEBEL
<b>APL-11</b>	P-SİSTEM için / For P-SYSTEM / FÜR P-SYSTEM TNMG 11 LEVYESİ / LEVER / KNIEHEBEL

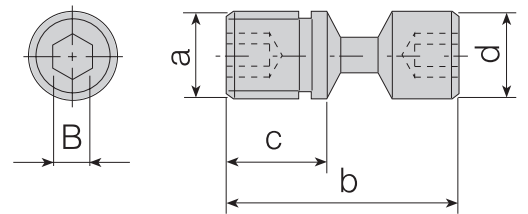

Takım Kodu  
Ordering Code  
Bestell-Bezeichnung

LEVYE VİDALARI / LEVER SCREWS / SCHRAUBEN FÜR KNIEHEBEL

	a (M)	b	c	d	B	Ürün Detayı / Product Detail / Produkt-Details
<b>ALV-01-M6X14</b>	M6x1.0	14	10	5.85	2.5	P-SİSTEM için / For P-SYSTEM / FÜR P-SYSTEM S20R PCLNR/L 09, S20R PDUNR/L 11, S20R PDQNR/L 11, S20R PVLNR/L 06, S20R PTUNR/L 16
<b>ALV-02-M6X17</b>	M6x1.0	17	10	5.85	2.5	P-SİSTEM için / For P-SYSTEM / FÜR P-SYSTEM CNMG 09, DNMG 11, SNMG 09, TNMG 16, WNMG 06
<b>ALV-03-M8X19</b>	M8X1.0	19.8	11	7.9	3	P-SİSTEM için / For P-SYSTEM / FÜR P-SYSTEM CNMG 12, SNMG 12, TNMG 22, WNMG 08, DNMG 15
<b>ALV-04-M8X22</b>	M8X1.0	21.5	13	7.75	3	P-SİSTEM için / For P-SYSTEM / FÜR P-SYSTEM CNMG 16, SNMG 15
<b>ALV-05-M10X27</b>	M10X1.0	27.5	15	9.9	4	P-SİSTEM için / For P-SYSTEM / FÜR P-SYSTEM CNMG 19, SNMG 19
<b>ALV-06-M12X36</b>	M12X1.0	36	20	12	5	P-SİSTEM için / For P-SYSTEM / FÜR P-SYSTEM CNMG 25, SNMG 25
<b>ALV-07-M6X13</b>	M6X0.1	12.6	6.5	5.9	2.5	P-SİSTEM için / For P-SYSTEM / FÜR P-SYSTEM S16P PCLNR/L 09, S16P PTUNR/L 16
<b>ALV-08-M8X16</b>	M8X1.0	16	10	7.9	3	P-SİSTEM için / For P-SYSTEM / FÜR P-SYSTEM S25S PCLNR/L 12, S25S PDUNR/L 15, S25S PSKNR/L 12
<b>ALV-10-M5X10</b>	M5x0.8	10	4.6	4.9	2.5	P-SİSTEM için / For P-SYSTEM / FÜR P-SYSTEM TNMG 11,

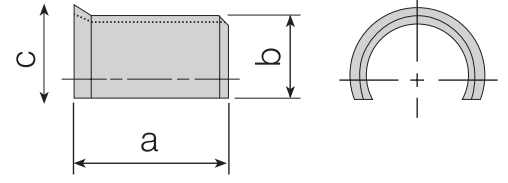

ALTLIK YAYLARI / SHIM SPRINGS / BEFESTIGUNGSFEDER

Takım Kodu Ordering Code Bestell-Bezeichnung	a	b	c	Ürün Detayı / Product Detail / Produkt-Details	
				Ürün Detayı / Product Detail / Produkt-Details	Ürün Detayı / Product Detail / Produkt-Details
AA-01	5.6	4.9	6	P-SİSTEM için / For P-SYSTEM / FÜR P-SYSTEM	CNMG 09 ,DNMG 11, SNMG 09, TNMG 16, WNMG 06
AA-02	6	6.9	7.9	P-SİSTEM için / For P-SYSTEM / FÜR P-SYSTEM	CNMG 12, SNMG 12, TNMG 22, WNMG 08, DNMG 15
AA-03	8.9	8	9.5	P-SİSTEM için / For P-SYSTEM / FÜR P-SYSTEM	CNMG 16, SNMG 15
AA-04	11	9.8	10.7	P-SİSTEM için / For P-SYSTEM / FÜR P-SYSTEM	CNMG 19, SNMG 19
AA-05	12	13	15	P-SİSTEM için / For P-SYSTEM / FÜR P-SYSTEM	CNMG 25, SNMG 25
AA-07	5.6	4.9	6	P-SİSTEM için / For P-SYSTEM / FÜR P-SYSTEM	CNMG 09, TNMG 16

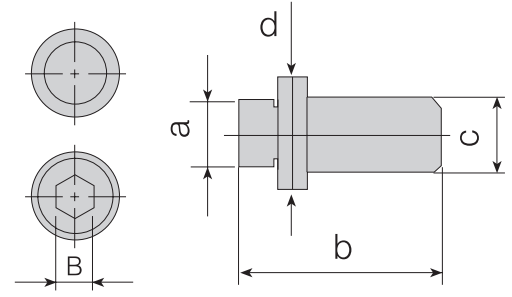

PİMLER / PINS / STIFT

Takım Kodu Ordering Code Bestell-Bezeichnung	a	b	c	d	B	Ürün Detayı / Product Detail / Produkt-Details	
						Ürün Detayı / Product Detail / Produkt-Details	Ürün Detayı / Product Detail / Produkt-Details
APM-01	3.55	18	5	6	-	M-SİSTEM için / For M-SYSTEM / FÜR T-SYSTEM	Delik İçi / Internal / Intern Ø32-Ø40 TNMG 16 Dış Çap / External / Externe TNMG 16
APM-02	5	18	6	7.3	-	M-SİSTEM için / For M-SYSTEM / FÜR T-SYSTEM	TNMG 22, WNMG 08
APM-03	3.5	12	5	6.5	-	M-SİSTEM için / For M-SYSTEM / FÜR T-SYSTEM	S20R MTFNR/L 16, S20R MT-NR/L 16, S20R MTUNR/L 16, S20R MTQNR/L 16, S20R MDUNR/L 11
APM-04	5	15	6	7.3	-	M-SİSTEM için / For M-SYSTEM / FÜR T-SYSTEM	S32T MCLNR/L 12, DNMG 15, S25S MWLNR/L 08
APM-05	5	11.5	6.5	6.5	3	M-SİSTEM için / For M-SYSTEM / FÜR T-SYSTEM	MSYNR 11.5CS 12 Kartuş için / for Cartridge / FÜR KASSETTE
APM-06	3	15.7	-	-	-	C-SİSTEM için / For C-SYSTEM / FÜR T-SYSTEM	154.91
APM-07	3.5	11.5	6.5	6.5	3	M-SİSTEM için / For M-SYSTEM / FÜR T-SYSTEM	S20R ET-NR 16
APM-08	3.5	12	5	5.4	-	M-SİSTEM için / For M-SYSTEM / FÜR T-SYSTEM	S25S MWLNR/L 06, Dış Çap / External / Externe
APM-09	3.5	10	5	5.4	-	M-SİSTEM için / For M-SYSTEM / FÜR T-SYSTEM	S16P MWLNR/L 06
APM-10	3.5	11	5	5.4	-	M-SİSTEM için / For M-SYSTEM / FÜR T-SYSTEM	S20R MWLNR/L 06
APM-11	3.5	11	5	6.5	-	M-SİSTEM için / For M-SYSTEM / FÜR T-SYSTEM	S20R MTQNR/L 16
APM-12	5	12	6	7.3	-	M-SİSTEM için / For M-SYSTEM / FÜR T-SYSTEM	S20R MCLNR/L 12, S25S MCLNR/L 12-Z
APM-13	5	14	6	7.3	-	M-SİSTEM için / For M-SYSTEM / FÜR T-SYSTEM	S25S MCLNR/L 12
APM-14	3.55	15	5	6	-	M-SİSTEM için / For M-SYSTEM / FÜR T-SYSTEM	S25S MTFNR/L 16, S25S MT-NR/L 16, S25S MTUNR/L 16, S25S MTQNR/L 16
APM-15	4.40	16	6.40	6.40	3	M-SİSTEM için / For M-SYSTEM / FÜR T-SYSTEM	MSYNR 16CS 12 Kartuş için / for Cartridge / FÜR KASSETTE

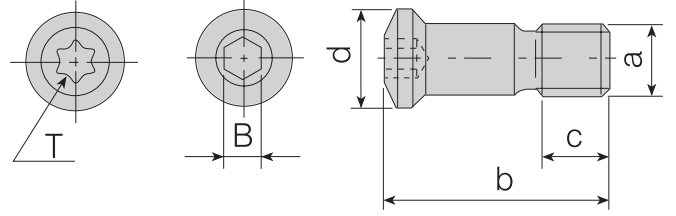

KÜRESEL FİNİŞ VİDALARI / BALL NOSE SCREWS / SCHRAUBE FÜR KUGELKOPFFRÄSER

Takım Kodu Ordering Code Bestell-Bezeichnung	a (M)	b	c	d	B(T)	Ürün Detayı / Product Detail / Produkt-Details	
1208-M3x7	M3x0.5	6.9	2.7	4.1	8	KÜRESEL FREZE VİDASI / BALL NOSE SCREW / SCHRAUBE FÜR KUGELFRÄSER	P3208
1215-M4X0.5X9	M4X0.5	8.6	3.2	5.75	15	KÜRESEL FREZE VİDASI / BALL NOSE SCREW / SCHRAUBE FÜR KUGELFRÄSER	P3210-ROHX 12
1220-M5X0.5X9	M5X0.5	9.6	3.4	6.8	20	KÜRESEL FREZE VİDASI / BALL NOSE SCREW / SCHRAUBE FÜR KUGELFRÄSER	P3212
1220-M5X0.5X12	M5X0.5	12.9	4.4	7.4	20	KÜRESEL FREZE VİDASI / BALL NOSE SCREW / SCHRAUBE FÜR KUGELFRÄSER	P3216-ROHX 16
1220-M5X0.5X15	M5X0.5	16.4	6	7.8	20	KÜRESEL FREZE VİDASI / BALL NOSE SCREW / SCHRAUBE FÜR KUGELFRÄSER	P3220-ROHX 20
1220-M6X0.75X20	M6X0.75	20	6	9.4	20	KÜRESEL FREZE VİDASI / BALL NOSE SCREW / SCHRAUBE FÜR KUGELFRÄSER	P3225
1204-M8X0.75X26	M8X0.75	26	7.5	12	4	KÜRESEL FREZE VİDASI / BALL NOSE SCREW / SCHRAUBE FÜR KUGELFRÄSER	P3232
1210-M3.5X9.6	M3.5X0.6	9.6	4	4.7	10	KÜRESEL FREZE VİDASI / BALL NOSE SCREW / SCHRAUBE FÜR KUGELFRÄSER	BNM 12
1215-M4X13.5	M4X0.7	13.5	5	5.8	15	KÜRESEL FREZE VİDASI / BALL NOSE SCREW / SCHRAUBE FÜR KUGELFRÄSER	BNM 16

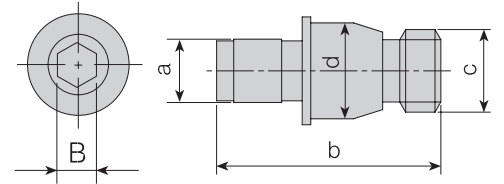
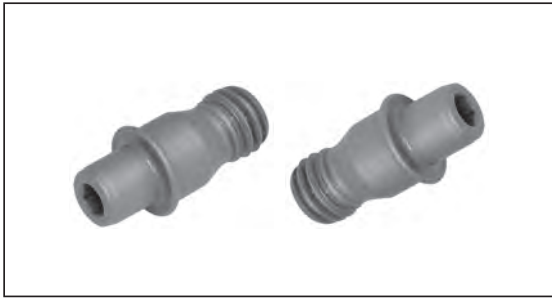

EKSANTRİK VİDA / ECCENTRIC SCREW / EXZENTERSCHRAUBEN

Takım Kodu Ordering Code Bestell-Bezeichnung	a	b	c	d	B	Ürün Detayı / Product Detail / Produkt-Details	
AEV-01-M6x16	4.85	16	M6x1.0	6.5	2.5	Eksantrik Vida / Eccentric Screw / EXZENTERSCHRAUBEN	PSDNN Kartuş için / for Cartridge / FÜR KASSETTE



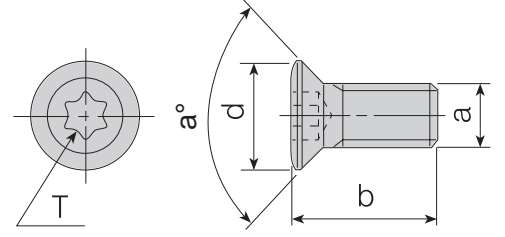

TORK VİDALARI / TORX SCREWS / TORX-SCHRAUBEN

Takım Kodu Ordering Code Bestell-Bezeichnung	a (M)	b	T	d	a°	Ürün Detayı / Product Detail / Produkt-Detaİls
4006-M1.6x3.2	M1.6X0.35	3.2	6	2.50	60	S-SİSTEM için / For S-SYSTEM / FÜR S-SYSTEM TORK VİDA / TORX SCREW / TORX-SCHRAUBEN
3006-M1.8x4	M1.8X0.35	4	6	2.45	60	S-SİSTEM için / For S-SYSTEM / FÜR S-SYSTEM TORK VİDA / TORX SCREW / TORX-SCHRAUBEN
3006-M2x3.1	M2X0.4	3.1	6	2.7	60	S-SİSTEM için / For S-SYSTEM / FÜR S-SYSTEM TORK VİDA / TORX SCREW / TORX-SCHRAUBEN
3006-M2x3.3	M2X0.4	3.3	6	2.7	60	S-SİSTEM için / For S-SYSTEM / FÜR S-SYSTEM TORK VİDA / TORX SCREW / TORX-SCHRAUBEN
3006-M2x3.6	M2X0.4	3.6	6	2.7	60	S-SİSTEM için / For S-SYSTEM / FÜR S-SYSTEM TORK VİDA / TORX SCREW / TORX-SCHRAUBEN
3006-M2x4	M2X0.4	4.3	6	2.7	60	S-SİSTEM için / For S-SYSTEM / FÜR S-SYSTEM TORK VİDA / TORX SCREW / TORX-SCHRAUBEN
4006-M2x5	M2X0.4	5	6	3	55	S-SİSTEM için / For S-SYSTEM / FÜR S-SYSTEM TORK VİDA / TORX SCREW / TORX-SCHRAUBEN
3007-M2.2x5	M2.2X0.45	5.2	7	3.15	60	S-SİSTEM için / For S-SYSTEM / FÜR S-SYSTEM TORK VİDA / TORX SCREW / TORX-SCHRAUBEN
4006-M2.2x5	M2.2X0.45	5	6	2.8	55	S-SİSTEM için / For S-SYSTEM / FÜR S-SYSTEM TORK VİDA / TORX SCREW / TORX-SCHRAUBEN
1008-M2.5x5	M2.5X0.45	5.5	8	3.5	45	S-SİSTEM için / For S-SYSTEM / FÜR S-SYSTEM TORK VİDA / TORX SCREW / TORX-SCHRAUBEN
1008-M2.5x7	M2.5X0.45	7	8	3.6	45	S-SİSTEM için / For S-SYSTEM / FÜR S-SYSTEM TORK VİDA / TORX SCREW / TORX-SCHRAUBEN
1108-M2.5x6	M2.5X0.45	6	8	3.9	R	S-SİSTEM için / For S-SYSTEM / FÜR S-SYSTEM TORK VİDA / TORX SCREW / TORX-SCHRAUBEN
3008-M2.5x5	M2.5X0.45	5	8	3.5	60	S-SİSTEM için / For S-SYSTEM / FÜR S-SYSTEM TORK VİDA / TORX SCREW / TORX-SCHRAUBEN
3008-M2.5x6	M2.5X0.45	6	8	3.5	60	S-SİSTEM için / For S-SYSTEM / FÜR S-SYSTEM TORK VİDA / TORX SCREW / TORX-SCHRAUBEN
3008-M2.5x8	M2.5X0.45	8	8	3.5	50	S-SİSTEM için / For S-SYSTEM / FÜR S-SYSTEM TORK VİDA / TORX SCREW / TORX-SCHRAUBEN
4008-M2.5x4	M2.5X0.45	4	8	3.5	45	S-SİSTEM için / For S-SYSTEM / FÜR S-SYSTEM TORK VİDA / TORX SCREW / TORX-SCHRAUBEN
4008-M2.5x4.5	M2.5X0.45	4.5	8	3.5	45	S-SİSTEM için / For S-SYSTEM / FÜR S-SYSTEM TORK VİDA / TORX SCREW / TORX-SCHRAUBEN
4008-M2.5x6	M2.5X0.45	5.8	8	3.5	45	S-SİSTEM için / For S-SYSTEM / FÜR S-SYSTEM TORK VİDA / TORX SCREW / TORX-SCHRAUBEN
4008-M2.5x6.5	M2.5X0.45	6.5	8	4	60	S-SİSTEM için / For S-SYSTEM / FÜR S-SYSTEM TORK VİDA / TORX SCREW / TORX-SCHRAUBEN
4108-M2.5x6.5	M2.5X0.45	6.5	8	3.5	50	S-SİSTEM için / For S-SYSTEM / FÜR S-SYSTEM TORK VİDA / TORX SCREW / TORX-SCHRAUBEN
4108-M2.5x8	M2.5X0.45	8	8	3.5	50	S-SİSTEM için / For S-SYSTEM / FÜR S-SYSTEM TORK VİDA / TORX SCREW / TORX-SCHRAUBEN
1008-M3x6	M3X0.5	6	8	4	60	S-SİSTEM için / For S-SYSTEM / FÜR S-SYSTEM TORK VİDA / TORX SCREW / TORX-SCHRAUBEN
1008-M3x8	M3X0.5	8	8	3.9	60	S-SİSTEM için / For S-SYSTEM / FÜR S-SYSTEM TORK VİDA / TORX SCREW / TORX-SCHRAUBEN
1108-M3x6.8	M3X0.5	6.8	8	4	60	S-SİSTEM için / For S-SYSTEM / FÜR S-SYSTEM TORK VİDA / TORX SCREW / TORX-SCHRAUBEN
3008-M3x6	M3X0.5	6	8	4	45	S-SİSTEM için / For S-SYSTEM / FÜR S-SYSTEM TORK VİDA / TORX SCREW / TORX-SCHRAUBEN
3008-M3x7	M3X0.5	7	8	4	55	S-SİSTEM için / For S-SYSTEM / FÜR S-SYSTEM TORK VİDA / TORX SCREW / TORX-SCHRAUBEN
3008-M3x8	M3X0.5	8	8	4	45	S-SİSTEM için / For S-SYSTEM / FÜR S-SYSTEM TORK VİDA / TORX SCREW / TORX-SCHRAUBEN
3108-M3x6	M3X0.5	6	8	3.8	60	S-SİSTEM için / For S-SYSTEM / FÜR S-SYSTEM TORK VİDA / TORX SCREW / TORX-SCHRAUBEN
3108-M3x8	M3X0.5	8	8	3.8	60	S-SİSTEM için / For S-SYSTEM / FÜR S-SYSTEM TORK VİDA / TORX SCREW / TORX-SCHRAUBEN
4008-M3x8	M3X0.5	8	8	4	60	S-SİSTEM için / For S-SYSTEM / FÜR S-SYSTEM TORK VİDA / TORX SCREW / TORX-SCHRAUBEN
4010-M3x6	M3X0.5	6	10	4.2	45	S-SİSTEM için / For S-SYSTEM / FÜR S-SYSTEM TORK VİDA / TORX SCREW / TORX-SCHRAUBEN
4010-M3x8	M3X0.5	8	10	4.2	45	S-SİSTEM için / For S-SYSTEM / FÜR S-SYSTEM TORK VİDA / TORX SCREW / TORX-SCHRAUBEN
1015-M3.5x9	M3.5X0.6	9	15	5.3	60	S-SİSTEM için / For S-SYSTEM / FÜR S-SYSTEM TORK VİDA / TORX SCREW / TORX-SCHRAUBEN
1015-M3.5x11	M3.5X0.6	11.1	15	5.3	60	S-SİSTEM için / For S-SYSTEM / FÜR S-SYSTEM TORK VİDA / TORX SCREW / TORX-SCHRAUBEN
1015-M3.5x14	M3.5X0.6	14	15	5.3	66	S-SİSTEM için / For S-SYSTEM / FÜR S-SYSTEM TORK VİDA / TORX SCREW / TORX-SCHRAUBEN
1315-M3.5x11	M3.5X0.6	10.6	15	7.9	-	S-SİSTEM için / For S-SYSTEM / FÜR S-SYSTEM TORK VİDA / TORX SCREW / TORX-SCHRAUBEN
1510-M3.5x7	M3.5X0.6	7.1	10	5.1	55	S-SİSTEM için / For S-SYSTEM / FÜR S-SYSTEM TORK VİDA / TORX SCREW / TORX-SCHRAUBEN
1510-M3.5x9	M3.5X0.6	9.1	10	5	55	S-SİSTEM için / For S-SYSTEM / FÜR S-SYSTEM TORK VİDA / TORX SCREW / TORX-SCHRAUBEN
1615-M3.5x10	M3.5X0.6	10	15	5.8	60	S-SİSTEM için / For S-SYSTEM / FÜR S-SYSTEM TORK VİDA / TORX SCREW / TORX-SCHRAUBEN
1615-M3.5x11	M3.5X0.6	11	15	5.8	60	S-SİSTEM için / For S-SYSTEM / FÜR S-SYSTEM TORK VİDA / TORX SCREW / TORX-SCHRAUBEN
1615-M3.5x15	M3.5X0.6	15	15	5.8	60	S-SİSTEM için / For S-SYSTEM / FÜR S-SYSTEM TORK VİDA / TORX SCREW / TORX-SCHRAUBEN
3010-M3.5x7	M3.5X0.6	7	10	5	55	S-SİSTEM için / For S-SYSTEM / FÜR S-SYSTEM TORK VİDA / TORX SCREW / TORX-SCHRAUBEN
3010-M3.5x9	M3.5X0.6	9	10	5	55	S-SİSTEM için / For S-SYSTEM / FÜR S-SYSTEM TORK VİDA / TORX SCREW / TORX-SCHRAUBEN
3015-M3.5x9	M3.5X0.6	8.8	15	5.4	60	S-SİSTEM için / For S-SYSTEM / FÜR S-SYSTEM TORK VİDA / TORX SCREW / TORX-SCHRAUBEN
4015-M3.5x8	M3.5X0.6	7.9	15	5.3	55	S-SİSTEM için / For S-SYSTEM / FÜR S-SYSTEM TORK VİDA / TORX SCREW / TORX-SCHRAUBEN
4015-M3.5x9	M3.5X0.6	8.7	15	5.3	60	S-SİSTEM için / For S-SYSTEM / FÜR S-SYSTEM TORK VİDA / TORX SCREW / TORX-SCHRAUBEN
4015-M3.5x10	M3.5X0.6	12	15	5.3	60	S-SİSTEM için / For S-SYSTEM / FÜR S-SYSTEM TORK VİDA / TORX SCREW / TORX-SCHRAUBEN



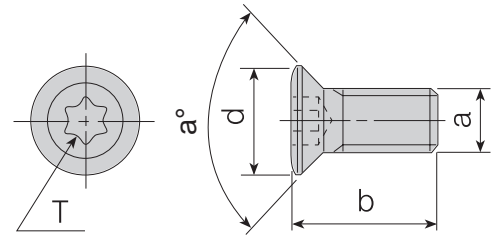

TORK VİDALARI / TORX SCREWS / TORX-SCHRAUBEN

Takım Kodu Ordering Code Bestell-Bezeichnung	a (M)	b	T	d	a°	Ürün Detayı / Product Detail / Produkt-Details
4015-M3.5x11	M3.5X0.6	13.7	15	5.3	60	S-SİSTEM için / For S-SYSTEM / FÜR S-SYSTEM TORK VİDA / TORX SCREW / TORX-SCHRAUBEN
4015-M3.5x12	M4X0.7	8	15	5.3	60	S-SİSTEM için / For S-SYSTEM / FÜR S-SYSTEM TORK VİDA / TORX SCREW / TORX-SCHRAUBEN
4015-M3.5x14	M4X0.7	9	15	5.3	60	S-SİSTEM için / For S-SYSTEM / FÜR S-SYSTEM TORK VİDA / TORX SCREW / TORX-SCHRAUBEN
1015-M4x8	M4X0.7	9	15	6.8	R	S-SİSTEM için / For S-SYSTEM / FÜR S-SYSTEM TORK VİDA / TORX SCREW / TORX-SCHRAUBEN
1015-M4x9	M4X0.7	10.8	15	6.8	R	S-SİSTEM için / For S-SYSTEM / FÜR S-SYSTEM TORK VİDA / TORX SCREW / TORX-SCHRAUBEN
1515-M4x9	M4X0.7	10	15	5.7	50	S-SİSTEM için / For S-SYSTEM / FÜR S-SYSTEM TORK VİDA / TORX SCREW / TORX-SCHRAUBEN
1015-M4x11	M4X0.7	11.1	15	6.8	R	S-SİSTEM için / For S-SYSTEM / FÜR S-SYSTEM TORK VİDA / TORX SCREW / TORX-SCHRAUBEN
1115-M4x10	M4X0.7	11	15	5.9	R	S-SİSTEM için / For S-SYSTEM / FÜR S-SYSTEM TORK VİDA / TORX SCREW / TORX-SCHRAUBEN
1315-M4x11	M4X0.7	11.1	15	5	45	S-SİSTEM için / For S-SYSTEM / FÜR S-SYSTEM TORK VİDA / TORX SCREW / TORX-SCHRAUBEN
1415-M4x11	M4X0.7	11.1	15	5.6	50	S-SİSTEM için / For S-SYSTEM / FÜR S-SYSTEM TORK VİDA / TORX SCREW / TORX-SCHRAUBEN
1515-M4x11	M4X0.7	9	15	5.6	50	S-SİSTEM için / For S-SYSTEM / FÜR S-SYSTEM TORK VİDA / TORX SCREW / TORX-SCHRAUBEN
1615-M4x11	M4X0.7	11	15	6	50	S-SİSTEM için / For S-SYSTEM / FÜR S-SYSTEM TORK VİDA / TORX SCREW / TORX-SCHRAUBEN
3015-M4x9	M4X0.7	8	15	5.6	50	S-SİSTEM için / For S-SYSTEM / FÜR S-SYSTEM TORK VİDA / TORX SCREW / TORX-SCHRAUBEN
3015-M4x11	M4X0.7	9	15	5.6	50	S-SİSTEM için / For S-SYSTEM / FÜR S-SYSTEM TORK VİDA / TORX SCREW / TORX-SCHRAUBEN
4015-M4x8	M4X0.7	10	15	5.6	50	S-SİSTEM için / For S-SYSTEM / FÜR S-SYSTEM TORK VİDA / TORX SCREW / TORX-SCHRAUBEN
4015-M4x9	M4X0.7	11	15	5.6	50	S-SİSTEM için / For S-SYSTEM / FÜR S-SYSTEM TORK VİDA / TORX SCREW / TORX-SCHRAUBEN
4015-M4x10	M4X0.7	12	15	5.6	50	S-SİSTEM için / For S-SYSTEM / FÜR S-SYSTEM TORK VİDA / TORX SCREW / TORX-SCHRAUBEN
4015-M4x11	M4X0.7	12	15	5.6	50	S-SİSTEM için / For S-SYSTEM / FÜR S-SYSTEM TORK VİDA / TORX SCREW / TORX-SCHRAUBEN
4015-M4x12	M4X0.7	8	15	5.7	50	S-SİSTEM için / For S-SYSTEM / FÜR S-SYSTEM TORK VİDA / TORX SCREW / TORX-SCHRAUBEN
4115-M4x12	M4X0.7	11	15	5.6	55	S-SİSTEM için / For S-SYSTEM / FÜR S-SYSTEM TORK VİDA / TORX SCREW / TORX-SCHRAUBEN
4515-M4x8	M4X0.7	11	15	5.1	50	S-SİSTEM için / For S-SYSTEM / FÜR S-SYSTEM TORK VİDA / TORX SCREW / TORX-SCHRAUBEN
4515-M4x11	M4.5X0.75	14	15	5.1	50	S-SİSTEM için / For S-SYSTEM / FÜR S-SYSTEM TORK VİDA / TORX SCREW / TORX-SCHRAUBEN
4615-M4x11	M4.5X0.75	16	15	6	50	S-SİSTEM için / For S-SYSTEM / FÜR S-SYSTEM TORK VİDA / TORX SCREW / TORX-SCHRAUBEN
1020-M4.5x14	M4.5X0.75	12.1	20	6.5	45	S-SİSTEM için / For S-SYSTEM / FÜR S-SYSTEM TORK VİDA / TORX SCREW / TORX-SCHRAUBEN
1020-M4.5x16	M4.5X0.75	11	20	6.5	45	S-SİSTEM için / For S-SYSTEM / FÜR S-SYSTEM TORK VİDA / TORX SCREW / TORX-SCHRAUBEN
1120-M4.5x12	M4.5X0.75	11	20	7.9	R	S-SİSTEM için / For S-SYSTEM / FÜR S-SYSTEM TORK VİDA / TORX SCREW / TORX-SCHRAUBEN
1515-M4.5x11	M4.5X0.75	10	15	6.4	45	S-SİSTEM için / For S-SYSTEM / FÜR S-SYSTEM TORK VİDA / TORX SCREW / TORX-SCHRAUBEN
4015-M4.5x11	M4.5X0.75	12	15	6.4	45	S-SİSTEM için / For S-SYSTEM / FÜR S-SYSTEM TORK VİDA / TORX SCREW / TORX-SCHRAUBEN
4020-M4.5x10	M5X0.8	7.5	20	6.5	55	S-SİSTEM için / For S-SYSTEM / FÜR S-SYSTEM TORK VİDA / TORX SCREW / TORX-SCHRAUBEN
4020-M4.5x12	M5X0.8	11	20	6.5	55	S-SİSTEM için / For S-SYSTEM / FÜR S-SYSTEM TORK VİDA / TORX SCREW / TORX-SCHRAUBEN
1020-M5x7.5	M5X0.8	14.1	20	6.6	50	S-SİSTEM için / For S-SYSTEM / FÜR S-SYSTEM TORK VİDA / TORX SCREW / TORX-SCHRAUBEN
1020-M5x11	M5X0.8	13	20	6.6	50	S-SİSTEM için / For S-SYSTEM / FÜR S-SYSTEM TORK VİDA / TORX SCREW / TORX-SCHRAUBEN
1020-M5x14	M5X0.8	14	20	6.8	50	S-SİSTEM için / For S-SYSTEM / FÜR S-SYSTEM TORK VİDA / TORX SCREW / TORX-SCHRAUBEN
1120-M5x13	M5X0.8	18	20	7	R	S-SİSTEM için / For S-SYSTEM / FÜR S-SYSTEM TORK VİDA / TORX SCREW / TORX-SCHRAUBEN
1615-M5x14	M5X0.8	22	15	7.3	50	S-SİSTEM için / For S-SYSTEM / FÜR S-SYSTEM TORK VİDA / TORX SCREW / TORX-SCHRAUBEN
1620-M5x18	M5X0.8	14	20	8.15	50	S-SİSTEM için / For S-SYSTEM / FÜR S-SYSTEM TORK VİDA / TORX SCREW / TORX-SCHRAUBEN
1620-M5x22	M6X1.0	16	20	8.15	50	S-SİSTEM için / For S-SYSTEM / FÜR S-SYSTEM TORK VİDA / TORX SCREW / TORX-SCHRAUBEN
4420-M5x14	M6X1.0	16	20	6.60	60	S-SİSTEM için / For S-SYSTEM / FÜR S-SYSTEM TORK VİDA / TORX SCREW / TORX-SCHRAUBEN
1020-M6x16	M6X1.0	16	20	8.5	50	S-SİSTEM için / For S-SYSTEM / FÜR S-SYSTEM TORK VİDA / TORX SCREW / TORX-SCHRAUBEN
1420-M6x16	UNC 5-40	12.2	20	7.6	50	S-SİSTEM için / For S-SYSTEM / FÜR S-SYSTEM TORK VİDA / TORX SCREW / TORX-SCHRAUBEN
1520-M6x16	UNC 8-32	10	20	8.2	50	S-SİSTEM için / For S-SYSTEM / FÜR S-SYSTEM TORK VİDA / TORX SCREW / TORX-SCHRAUBEN
1710-U5-40x12.2	UNC 8-32	15	10	5.6	60	S-SİSTEM için / For S-SYSTEM / FÜR S-SYSTEM TORK VİDA / TORX SCREW / TORX-SCHRAUBEN
1720-U8-32x10	UNF 4-48	6	20	7.5	60	S-SİSTEM için / For S-SYSTEM / FÜR S-SYSTEM TORK VİDA / TORX SCREW / TORX-SCHRAUBEN
1720-U8-32x15	UNF 4-48	6.5	20	7.5	60	S-SİSTEM için / For S-SYSTEM / FÜR S-SYSTEM TORK VİDA / TORX SCREW / TORX-SCHRAUBEN
1707-U4-48x6	UNF 4-48	8.2	7	3.27	60	S-SİSTEM için / For S-SYSTEM / FÜR S-SYSTEM TORK VİDA / TORX SCREW / TORX-SCHRAUBEN
1707-U4-48x6.5	M3.5X0.6	9.8	7	3.27	60	S-SİSTEM için / For S-SYSTEM / FÜR S-SYSTEM TORK VİDA / TORX SCREW / TORX-SCHRAUBEN
1707-U4-48x8.2	M3.5X0.6	10.7	7	3.27	60	S-SİSTEM için / For S-SYSTEM / FÜR S-SYSTEM TORK VİDA / TORX SCREW / TORX-SCHRAUBEN

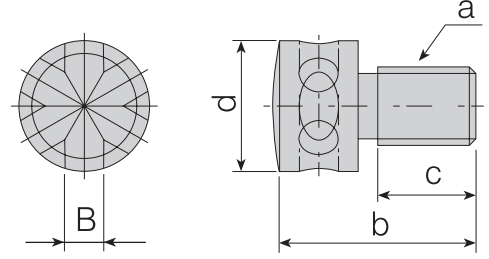

EKSENEL AYAR VİDALARI / AXIAL ADJUSTING SCREWS / AXIAL-EINSTELLSCHRAUBE

Takım Kodu Ordering Code Bestell-Bezeichnung	a (M)	b	c	d	B	Ürün Detayı / Product Detail / Produkt-Details
2600-M4x9.5	M4x0.5	5.5	4	4	1.5	Kartuş için / for Cartridge / FÜR KASSETTE   Eksenel Ayar Vida / Axial Adjust Screw / Axial-Einstellschraube
2600-M5x13	M5x0.5	12.8	7	8.7	2.5	Kartuş için / for Cartridge / FÜR KASSETTE   Eksenel Ayar Vida / Axial Adjust Screw / Axial-Einstellschraube
2600-M6x18	M6x1.0	18.2	9	10	3.5	Kartuş için / for Cartridge / FÜR KASSETTE   Eksenel Ayar Vida / Axial Adjust Screw / Axial-Einstellschraube

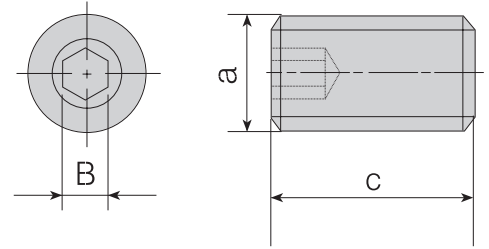

RADYAL AYAR VİDALARI / RADIAL ADJUSTING SCREWS / AXIAL-EINSTELLSCHRAUBE

Takım Kodu Ordering Code Bestell-Bezeichnung	a (M)	c	B	Ürün Detayı / Product Detail / Produkt-Details
2715-M3x4	M3x0.5	4	1.5	KABA BARA için / for ROUGH BORING HEADS FÜR SCHRUPP-SPINDELKOPF   KABA BARA KARTUŞU için / for ROUGH BORING HEADS CARTRIDGE FÜR KASSETTEN DER SCHRUPP-SPINDELKÖPFE
2715-M3x5	M3x0.5	5	1.5	KABA BARA için / for ROUGH BORING HEADS FÜR SCHRUPP-SPINDELKOPF   KABA BARA KARTUŞU için / for ROUGH BORING HEADS CARTRIDGE FÜR KASSETTEN DER SCHRUPP-SPINDELKÖPFE
2715-M3x8	M3x0.5	8	1.5	KABA BARA için / for ROUGH BORING HEADS FÜR SCHRUPP-SPINDELKOPF   KABA BARA KARTUŞU için / for ROUGH BORING HEADS CARTRIDGE FÜR KASSETTEN DER SCHRUPP-SPINDELKÖPFE
2702-M4x4	M4x0.7	4	2	KARTUŞ için / for CARTRIDGE / FÜR KASSETTE   KARTUŞ için / for CARTRIDGE / FÜR KASSETTE
2702-M4x10	M4x0.7	10	2	KARTUŞ için / for CARTRIDGE / FÜR KASSETTE   KARTUŞ için / for CARTRIDGE / FÜR KASSETTE
2702-M4x12	M4x0.7	12	2	KABA BARA için / for ROUGH BORING HEADS FÜR SCHRUPP-SPINDELKOPF   KABA BARA KARTUŞU için / for ROUGH BORING HEADS CARTRIDGE FÜR KASSETTEN DER SCHRUPP-SPINDELKÖPFE
2725-M5x6	M5x0.8	5	2.5	KARTUŞ için / for CARTRIDGE / FÜR KASSETTE   KARTUŞ için / for CARTRIDGE / FÜR KASSETTE
2725-M5x10	M5x0.8	10	2.5	KARTUŞ için / for CARTRIDGE / FÜR KASSETTE   KARTUŞ için / for CARTRIDGE / FÜR KASSETTE
2725-M5x12	M5x0.8	12	2.5	KABA BARA için / for ROUGH BORING HEADS FÜR SCHRUPP-SPINDELKOPF   KABA BARA KARTUŞU için / for ROUGH BORING HEADS CARTRIDGE FÜR KASSETTEN DER SCHRUPP-SPINDELKÖPFE
2725-M5x14	M5x0.8	14	2.5	KABA BARA için / for ROUGH BORING HEADS FÜR SCHRUPP-SPINDELKOPF   KABA BARA KARTUŞU için / for ROUGH BORING HEADS CARTRIDGE FÜR KASSETTEN DER SCHRUPP-SPINDELKÖPFE
2703-M6x16	M6x1	16	3	KABA BARA için / for ROUGH BORING HEADS FÜR SCHRUPP-SPINDELKOPF   KABA BARA KARTUŞU için / for ROUGH BORING HEADS CARTRIDGE FÜR KASSETTEN DER SCHRUPP-SPINDELKÖPFE
2704-M8x25	M8x1.25	25.9	4	KABA BARA için / for ROUGH BORING HEADS FÜR SCHRUPP-SPINDELKOPF   KABA BARA KARTUŞU için / for ROUGH BORING HEADS CARTRIDGE FÜR KASSETTEN DER SCHRUPP-SPINDELKÖPFE
2704-M8x1x5	M8x1	5	4	İÇTEN SOĞUTMA KANALLI TAKIMLAR için / for COOLANT TOOLS / FÜR AUSSEN-DREHHALTER   JET TAKIMLAR için / For JET TOOLS / FÜR JET WERKZEUGE
2705-G1/8x5.5	G1/8	5.5	5	İÇTEN SOĞUTMA KANALLI TAKIMLAR için / for COOLANT TOOLS / FÜR AUSSEN-DREHHALTER   JET TAKIMLAR için / For JET TOOLS / FÜR JET WERKZEUGE



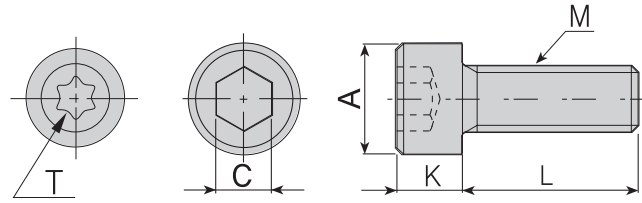

İNBUS CİVATALAR / INBUS SCREWS / INNENSECHSKANT-SCHRAUBE

Takım Kodu Ordering Code Bestell-Bezeichnung	M	A	C	K	L	Ürün Detayı / Product Detail / Produkt-Details	
						Ürün Detayı / Product Detail / Produkt-Details	SCHRAUBEN FÜR STECHHALTER
2503-M4x10	M4x0.7	6.85	3	4	10	KANAL KATER VİDASI / SOME GROOVING TOOLS SCREW	SCHRAUBEN FÜR STECHHALTER
2525-M3X14	M3X0.5	5.4	2.5	2.9	14	BARA KARTUŞU için SIKMA VİDASI / for BORING HEADS CARTRIDGE SCREW	SCHRAUBE FÜR KASSETTE DER SCHRUPP-SPINDELKÖPFE
2503-M4X20	M4x0.7	7	3	3.9	20	BARA KARTUŞU için SIKMA VİDASI / for BORING HEADS CARTRIDGE SCREW	SCHRAUBE FÜR KASSETTE DER SCHRUPP-SPINDELKÖPFE
2503-M4X12	M4x0.7	6.85	3	4	12	KANAL KATER VİDASI / SOME GROOVING TOOLS SCREW	SCHRAUBEN FÜR STECHHALTER
2503-M4X15	M4x0.7	6.85	3	4	15	BARA KARTUŞU için SIKMA VİDASI / for BORING HEADS CARTRIDGE SCREW	SCHRAUBE FÜR KASSETTE DER SCHRUPP-SPINDELKÖPFE
2504-M5X16	M5X0.8	8.5	4	5	16	KANAL KATER VİDASI / SOME GROOVING TOOLS SCREW	SCHRAUBEN FÜR STECHHALTER
2504-M5X12	M5X0.8	8.5	4	5	12	KANAL KATER VİDASI / SOME GROOVING TOOLS SCREW	SCHRAUBEN FÜR STECHHALTER
2504-M5X25	M5X0.8	8.5	4	5	25	BARA KARTUŞU için SIKMA VİDASI / for BORING HEADS CARTRIDGE SCREW	SCHRAUBE FÜR KASSETTE DER SCHRUPP-SPINDELKÖPFE
2505-M6X16	M6X1	9.9	5	6	16	KANAL KATER VİDASI / SOME GROOVING TOOLS SCREW	SCHRAUBEN FÜR STECHHALTER
2505-M6X20	M6X1	9.9	5	6	20	KANAL KATER VİDASI / SOME GROOVING TOOLS SCREW	SCHRAUBEN FÜR STECHHALTER
2505-M6X25	M6X1	9.9	5	6	25	BLOK BASKI PABUÇ VİDASI / for BLOCK CLAMP SCREW	SCHRAUBE FÜR SPANNBLOCK
2505-M6X30	M6X1	9.9	5	6	30	BARA KARTUŞU için SIKMA VİDASI / for BORING HEADS CARTRIDGE SCREW	SCHRAUBE FÜR KASSETTE DER SCHRUPP-SPINDELKÖPFE
2306-M8X37	M8X1.25	13	6	6.4	31.5	MONTAJ VİDASI (KAFASI KÜÇÜK) / MOUNTING SCREW (SMALL HEAD)	BEFESTIGUNGSSCHRAUBE
2405-M8X30	M8X1.25	13	5	5	30	A16 MONTAJ VİDASI (KAFASI KÜÇÜK) / MOUNTING SCREW (SMALL HEAD)	BEFESTIGUNGSSCHRAUBE (KLEINER KOPF)
2506-M8X20	M8X1.25	13	6	7.9	20	KARTUŞ MONTAJ VİDASI / CARTRIDGE MOUNTING SCREW	BEFESTIGUNGSSCHRAUBE FÜR KASSETTE
2506-M8X30	M8X1.25	13	6	7.9	30	A16 MONTAJ VİDASI / MOUNTING SCREW	BEFESTIGUNGSSCHRAUBE
2506-M8X35	M8X1.25	13	6	7.9	35	BARA KARTUŞU için SIKMA VİDASI / for BORING HEADS CARTRIDGE SCREW	SCHRAUBE FÜR KASSETTE DER SCHRUPP-SPINDELKÖPFE
2406-M8X30	M8X1.25	12	6	7.9	30	A16 MONTAJ VİDASI / MOUNTING SCREW	BEFESTIGUNGSSCHRAUBE
2407-M10X30	M10X1.5	16	7	6	30	A16 MONTAJ VİDASI / MOUNTING SCREW	BEFESTIGUNGSSCHRAUBE
2408-M10X30	M10X1.5	13	8	10	30	A22 MONTAJ VİDASI / MOUNTING SCREW	BEFESTIGUNGSSCHRAUBE
2508-M10X30	M10X1.5	16	8	10	30	A22 MONTAJ VİDASI / MOUNTING SCREW	BEFESTIGUNGSSCHRAUBE
2508-M10X40	M10X1.5	16	8	10	40	BARA KARTUŞU için SIKMA VİDASI / for BORING HEADS CARTRIDGE SCREWS	SCHRAUBE FÜR KASSETTE DER SCHRUPP-SPINDELKÖPFE
2408-M12X35	M12X1.75	18	8	7	35	A27 MONTAJ VİDASI / MOUNTING SCREW	BEFESTIGUNGSSCHRAUBE
2510-M12X35	M12X1.75	18	10	12	35	A27 MONTAJ VİDASI / MOUNTING SCREW	BEFESTIGUNGSSCHRAUBE
2514-M16X35	M16X2.0	23.7	14	16	35	A32 MONTAJ VİDASI / MOUNTING SCREW	BEFESTIGUNGSSCHRAUBE
AAV-11-U5-40x4.5	UNC 5-40	5.4	T10	2.8	4.5	16 ER/L, 16 IR/L ALTLIK VİDASI / SHIM SCREW	SCHRAUBE FÜR UNTERLAGE
AAV-12-U8-32x5.5	UNC 8-32	6.7	T20	3.8	5.5	22 ER/L, 22 IR/L ALTLIK VİDASI / SHIM SCREW	SCHRAUBE FÜR UNTERLAGE
AAV-15-M5x5.7	M5X0.8	8.5	T20	3.15	5.7	27 ER/L, 27 IR/L ALTLIK VİDASI / SHIM SCREW	SCHRAUBE FÜR UNTERLAGE

SEKMAN / RING / RING

Ürün Resmi Product Picture Produkt-Bild	Ürün Detayı / Product Detail / Produkt-Details	
	Ürün Kodu Product Code / Code	Ürün Detayı / Product Detail / Produkt-Details
	ACS-01	C-SİSTEM için / For C-SYSTEM / FÜR C-SYSTEM
	AS-01	T-M-SİSTEM için / For T-M-SYSTEM / FÜR T-M-SYSTEM
	AS-02	T SİSTEM için / For T SYSTEM / FÜR T SYSTEM
	TNGN, CNGN, DNGN, SNGN SEKMANI / RING	
	AKV-30-M6x22 SEKMANI / RING	
	AKV-19-M7x25 SEKMANI / RING	

ORING / ORING / ORING

Ürün Resmi Product Picture Produkt-Bild	ORING / ORING / ORING		
	Ürün Kodu Product Code / Code	Ürün Detayı / Product Detail / Produkt-Details	
	<b>AOR-01</b>	P-SİSTEM için / For P-SYSTEM / FÜR P-SYSTEM ORING	
	<b>AXR-01</b>	T-P SİSTEM için / For T-P SYSTEM / FÜR T-P-SYSTEM ORING	

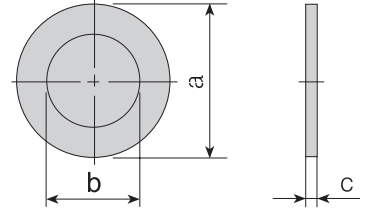
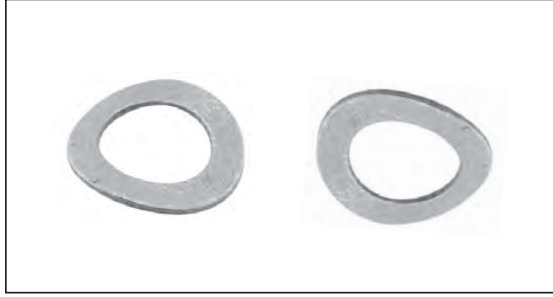

BASKI VE ALTLIK VİDASI PULU / STAMP / UNTERLEGSCHIEBE

Takım Kodu Ordering Code Bestell-Bezeichnung	a	b	c	Ürün Detayı / Product Detail / Produkt-Details	
				<b>ABPL-01</b>	10.5
<b>ABPL-02</b>	12.75	7.1	0.45	PUL/STAMP/RING	BASKI PULU / STAMP / RING
<b>ABPL-03</b>	5.3	3.2	0.5	PUL/STAMP/RING	TER - TIR 16 ER/EL - IR/İL ALTLIK VİDA PULU / SHIM SCREW RING / SCHRAUBE FÜR UNTERLAGENRING
<b>ABPL-04</b>	6.9	4.2	0.5	PUL/STAMP/RING	TER - TIR 22 ER/EL - IR/İL ALTLIK VİDA PULU / SHIM SCREW RING / SCHRAUBE FÜR UNTERLAGENRING
<b>ABPL-05</b>	8.5	5	0.5	PUL/STAMP/RING	TER - TIR 27 ER/EL - IR/İL ALTLIK VİDA PULU / SHIM SCREW RING / SCHRAUBE FÜR UNTERLAGENRING

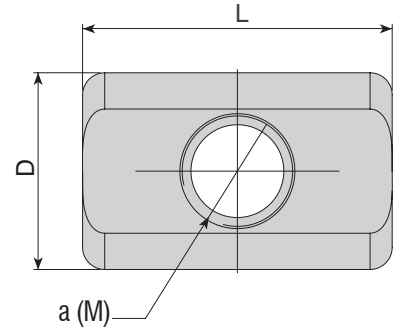



BARA PABUÇLARI / BORING HEADS CARTRIDGE / KASSETTE FÜR SPINDELKOPF

Takım Kodu Ordering Code Bestell-Bezeichnung	a (M)	D	L	Ürün Detayı / Product Detail / Produkt-Details	
				<b>ABKS-D16</b>	M3x0.5
<b>ABKS-D20</b>	M4x0.7	5.9	9	KABA BARA için / for ROUGH BORING HEADS / FÜR SCHRUPP-SPINDELKOPF	ABHR-D20x50-W20-L100
<b>ABKS-D25</b>	M4x0.7	5.9	12	KABA BARA için / for ROUGH BORING HEADS / FÜR SCHRUPP-SPINDELKOPF	ABHR-D25x60-W20-L110
<b>ABKS-D32</b>	M5x0.8	8.9	14	KABA BARA için / for ROUGH BORING HEADS / FÜR SCHRUPP-SPINDELKOPF	ABHR-D32x64-W25-L120
<b>ABKS-D40</b>	M6x1	10.9	18	KABA BARA için / for ROUGH BORING HEADS / FÜR SCHRUPP-SPINDELKOPF	ABHR-D40x80-W32-L140
<b>ABKS-D50</b>	M8x1.25	13.9	28	KABA BARA için / for ROUGH BORING HEADS / FÜR SCHRUPP-SPINDELKOPF	ABHR-D50x100-W32-L160
<b>ABKS-D63</b>	M10x1.5	15.9	35	KABA BARA için / for ROUGH BORING HEADS / FÜR SCHRUPP-SPINDELKOPF	ABHR-D63x80-W32-L140, ABHR-D63x130-W40-L200
<b>ABKS-D80</b>	M12x1.75	17.9	45	KABA BARA için / for ROUGH BORING HEADS / FÜR SCHRUPP-SPINDELKOPF	ABHR-D80x140-W40-L210, ABHR-D80x140-W40-L210-B





Ürün Resmi Product Picture Produkt-Bild	KESME ve KANAL LAMA AÇMA BLOK PABUÇLARI / BLOCKS FOR PARTING AND DEEP GROOVING BLADES CLAMPS KLEMMLEISTE FÜR SCHWERT-SPANNBLOCK		
	Ürün Kodu Product Code / Code	Ürün Detayı / Product Detail / Produkt-Details	
	<b>ABK-01</b>	LAMA BLOĞU için / For BLADE BLOCK / FÜR SCHWERT-SPANNBLOCK	ALBU-20-26 BASKI PABUCU / CLAMP / PRATZE
	<b>ABK-02</b>	LAMA BLOĞU için / For BLADE BLOCK / FÜR SCHWERT-SPANNBLOCK	ALBU-25-26 BASKI PABUCU / CLAMP / PRATZE
	<b>ABK-03</b>	LAMA BLOĞU için / For BLADE BLOCK / FÜR SCHWERT-SPANNBLOCK	ALBU-20-32 BASKI PABUCU / CLAMP / PRATZE
	<b>ABK-04</b>	LAMA BLOĞU için / For BLADE BLOCK / FÜR SCHWERT-SPANNBLOCK	ALBU-25-32, ALBU-32-32 BASKI PABUCU / CLAMP / PRATZE

Ürün Resmi Product Picture Produkt-Bild	LAMA ANAHTARI / BLADE KEY / SCHWERT-SCHLÜSSEL	
	Ürün Kodu Product Code / Code	Ürün Detayı / Product Detail / Produkt-Details
	<b>ALA-01</b>	AKL LAMA ANAHTARI / for BLADE KEY / SCHWERT-SCHLÜSSEL
	<b>ALA-02</b>	AKL LAMA ANAHTARI / for BLADE KEY / SCHWERT-SCHLÜSSEL

Ürün Resmi Product Picture Produkt-Bild	ALYAN ANAHTARLARI / ALLEN KEYS / INNENSECHSKANT-SCHLÜSSEL	
	Ürün Kodu Product Code / Code	Ürün Detayı / Product Detail / Produkt-Details
	<b>AAL-01-2</b>	2 mm ALYAN ANAHTARI / ALLEN KEYS / INNENSECHSKANT-SCHLÜSSEL
	<b>AAL-02-2.5</b>	2.5 mm ALYAN ANAHTARI / ALLEN KEYS / INNENSECHSKANT-SCHLÜSSEL
	<b>AAL-03-3</b>	3 mm ALYAN ANAHTARI / ALLEN KEYS / INNENSECHSKANT-SCHLÜSSEL
	<b>AAL-05-4</b>	4 mm ALYAN ANAHTARI / ALLEN KEYS / INNENSECHSKANT-SCHLÜSSEL
	<b>AAL-07-5</b>	5 mm ALYAN ANAHTARI / ALLEN KEYS / INNENSECHSKANT-SCHLÜSSEL
	<b>AAL-08-6</b>	6 mm ALYAN ANAHTARI / ALLEN KEYS / INNENSECHSKANT-SCHLÜSSEL
	<b>AAL-09-1.5</b>	1.5 mm ALYAN ANAHTARI / ALLEN KEYS / INNENSECHSKANT-SCHLÜSSEL
	<b>AAL-11-8</b>	8 mm ALYAN ANAHTARI / ALLEN KEYS / INNENSECHSKANT-SCHLÜSSEL
	<b>AAL-12-10</b>	10 mm ALYAN ANAHTARI / ALLEN KEYS / INNENSECHSKANT-SCHLÜSSEL

Ürün Resmi Product Picture Produkt-Bild	TORK ANAHTARLARI / TORX KEYS / TORX-SCHLÜSSEL	
	Ürün Kodu Product Code / Code	Ürün Detayı / Product Detail / Produkt-Details
	<b>80-T06</b>	T06 TORK ANAHTARI / TORX KEY / TORX-SCHLÜSSEL
	<b>80-T07</b>	T07 TORK ANAHTARI / TORX KEY / TORX-SCHLÜSSEL
	<b>80-T08</b>	T08 TORK ANAHTARI / TORX KEY / TORX-SCHLÜSSEL
	<b>80-T10</b>	T10 TORK ANAHTARI / TORX KEY / TORX-SCHLÜSSEL
	<b>80-T15</b>	T15 TORK ANAHTARI / TORX KEY / TORX-SCHLÜSSEL
	<b>80-T20</b>	T20 TORK ANAHTARI / TORX KEY / TORX-SCHLÜSSEL
	<b>81-T15</b>	T15 T-TİP TORK ANAHTARI / T-TYPE TORX KEY / T-TYP-TORX-SCHLÜSSEL
	<b>81-T20</b>	T20 T-TİP TORK ANAHTARI / T-TYPE TORX KEY / T-TYP-TORX-SCHLÜSSEL

KOD / CODE	AÇIKLAMA / DESCRIPTION	BESCHREIBUNG	S.N. / P.N. SEITE
A/PTFNR/L ..	Boring Bars	Bohstangen	108
A/SCLCR/L ..	Boring Bars SET	Bohstangen Set	127
A/SDUCR/L ..	Boring Bars SET	Bohstangen Set	128
AAKT-IG-R/L ..	Face External Grooving Tool Holders	Axial Stechhalter	179
AAKT-KG-R/L ..	Face External Grooving Tool Holders	Axial Stechhalter	178
AAKT-K-R/L ..	Face External Grooving Tool Holders	Axial Stechhalter	177
AAKT-ZCC2-R/L ..	Face External Grooving Tool Holders	Axial Stechhalter	178
AAUT-T20-R/L	Corner Reliefs Grooving Toolholders	Stechwerkzeug für Freistiche	16
ABHR ..	Adjustable Rough Boring Heads	Einstellbare Schrupp-Spindelköpfe	237
ABHRS ..	Adjustable Rough Boring Heads Body	Trägerwerkzeug für einstellbare Schrupp-Spindelköpfe	238
ABT-B4..	Broaching Toolholders	Räumwerkzeug	18
ACBM ..	Countersink Open Milling Tools	Senkwerkzeug f.Zylinderkopfschrauben	245
ACM ..	Chamfering End Mills	Fasfräser	243
ACM45-SP.	Chamfering End Mills	Fasfräser	244
ACPBT-..	Pipe Beveling Tools	Rohrendenanfaswerkzeug	147
ADCR	Drill Chamfering Ring Tools	Fasring für Vollbohrer	228
ADKT-123-R/L ..	External Grooving Tool Holders	Außen - Stechhalter	165
ADKT-151.22-R/L ..	External Grooving Tool Holders	Außen - Stechhalter	166
ADKT-151.23-R/L ..	External Grooving Tool Holders	Außen - Stechhalter	166
ADKT-154.91-R/L ..	External Grooving Tool Holders	Außen - Stechhalter	167
ADKT-ARN-R/L ..	External Grooving Tool Holders	Außen - Stechhalter	167
ADKT-CD-R/L ..	External Grooving Tool Holders	Außen - Stechhalter	172
ADKT-GP-R/L ..	External Grooving Tool Holders	Außen - Stechhalter	171
ADKT-H22-R/L ..	External Grooving Tool Holders	Außen - Stechhalter	170
ADKT-HK-R/L ..	External Grooving Tool Holders	Außen - Stechhalter	161
ADKT-H-R/L ..	External Grooving Tool Holders	Außen - Stechhalter	160
ADKT-HS223-R/L ..	External Grooving Tool Holders	Außen - Stechhalter	160
ADKT-IDC-R/L ..	External Grooving Tool Holders	Außen - Stechhalter	164
ADKT-IGI-R/L ..	External Grooving Tool Holders	Außen - Stechhalter	164
ADKT-IG-R/L ..	External Grooving Tool Holders	Außen - Stechhalter	164
ADKT-IGTN-R/L ..	External Grooving Tool Holders	Außen - Stechhalter	164
ADKT-I-R/L ..	External Grooving Tool Holders	Außen - Stechhalter	164
ADKT-I-R/L ..S	External Grooving (Swiss Type) Tool Holders	Außen - Stechhalter ( Swiss Type )	174
ADKT-ITG-R/L ..	External Grooving Tool Holders	Außen - Stechhalter	163
ADKT-KG-R/L ..	External Grooving Tool Holders	Außen - Stechhalter	159
ADKT-KG-R/L ..S	External Grooving (Swiss Type) Tool Holders	Außen - Stechhalter ( Swiss Type )	175
ADKT-KM-R/L ..	External Grooving Tool Holders	Außen - Stechhalter	163
ADKT-K-R/L ..	External Grooving Tool Holders	Außen - Stechhalter	158
ADKT-K-R/L .. -H	External Grooving Tool Holders With Coolant Tools	Externe Nutwerkzeughalter Mit Kühlwerkzeug	185
ADKT-K-R/L ..S	External Grooving (Swiss Type) Tool Holders	Außen - Stechhalter ( Swiss Type )	175
ADKT-LGC-R/L ..	External Grooving Tool Holders	Außen - Stechhalter	169
ADKT-RD-R/L ..	External Grooving Tool Holders	Außen - Stechhalter	169
ADKT-RD-R/L .. -S	External Grooving (Swiss Type) Tool Holders	Außen - Stechhalter ( Swiss Type )	173

KOD / CODE	AÇIKLAMA / DESCRIPTION	BESCHREIBUNG	S.N. / P.N. SEITE
ADKT-SGC-R/L ..	External Grooving Tool Holders	Außen - Stechhalter	160
ADKT-SWC-R/L ..	External Grooving Tool Holders	Außen - Stechhalter	172
ADKT-T12P-R/L	Poly-V Grooving Toolholders	Poly-V Riemenmuten	12
ADKT-TD-R/L ..	External Grooving Tool Holders	Außen - Stechhalter	168
ADKT-TD-R/L ..S	External Grooving (Swiss Type) Tool Holders	Außen - Stechhalter ( Swiss Type )	173
ADKT-TD-R/L..-H	External Grooving Tool Holders With Coolant Tools	Externe Nutwerkzeughalter Mit Kühlwerkzeug	185
ADKT-TG-R/L ..	External Grooving Tool Holders	Außen - Stechhalter	170
ADKT-TG-R/L .. -S	External Grooving (Swiss Type) Tool Holders	Außen - Stechhalter ( Swiss Type )	176
ADKT-WGX..-R/L ..	External Grooving Tool Holders	Außen - Stechhalter	171
ADKT-WGX..-R/L ..S	External Grooving (Swiss Type) Tool Holders	Außen - Stechhalter ( Swiss Type )	176
ADKT-ZCC1-R/L ..	External Grooving Tool Holders	Außen - Stechhalter	161
ADKT-ZCC2-R/L ..	External Grooving Tool Holders	Außen - Stechhalter	162
ADKT-ZCC2-R/L ..S	External Grooving (Swiss Type) Tool Holders	Außen - Stechhalter ( Swiss Type )	174
AEKR/L ..	Economic Cutting Tools	Multifunktionales Werkzeug	234
AEM90-3P..	End Mills	Schafffräser	270
AEM90-3P..	Modular End Mills	Einschraubfräser	291
AEM90-4N..	End Mills	Schafffräser	271
AEM90-AD..	End Mills	Schafffräser	246-247-248
AEM90-AD..	Modular End Mills	Einschraubfräser	286
AEM90-AN..	End Mills	Schafffräser	248-249
AEM90-AO..	End Mills	Schafffräser	255
AEM90-AO..	Modular End Mills	Einschraubfräser	285
AEM90-AP..	End Mills	Schafffräser	250-251-252-253-254-255
AEM90-AP..	Modular End Mills	Einschraubfräser	287
AEM90-AX..	End Mills	Schafffräser	256-257
AEM90-AX..	Modular End Mills	Einschraubfräser	286
AEM90-AZ..	End Mills	Schafffräser	258
AEM90-BD..	End Mills	Schafffräser	259
AEM90-BD.. -H	Modular End Mills ( Screw Type Tools )	Einschraubfräser	288
AEM90-DC..	Modular End Mills	Einschraubfräser	288
AEM90-ED..	End Mills	Schafffräser	260
AEM90-LN..	End Mills	Schafffräser	260-261-262
AEM90-R390..	End Mills	Schafffräser	262
AEM90-R390..	Modular End Mills	Einschraubfräser	289
AEM90-RT..	End Mills	Schafffräser	263
AEM90-RT..	Modular End Mills	Einschraubfräser	289
AEM90-SE..	End Mills	Schafffräser	264
AEM90-SO..	End Mills	Schafffräser	264
AEM90-SPGT..	End Mills	Schafffräser	265
AEM90-TNG..	End Mills	Schafffräser	265
AEM90-TNG.. -H	Modular End Mills ( Screw Type Tools )	Einschraubfräser	290
AEM90-VC2205.. -H	End Mills	Schafffräser	266

KOD / CODE	AÇIKLAMA / DESCRIPTION	BESCHREIBUNG	SN. / PN. SEITE	KOD / CODE	AÇIKLAMA / DESCRIPTION	BESCHREIBUNG	SN. / PN. SEITE
AEM90-WN..	End Mills	Schafffräser	267	AFM90(S)-SD..	Face Milling	Plan-und Eckmesserköpfe	339
AEM90-WN..	Modular End Mills	Einschraubfräser	290	AFM90-3P..	Face Milling	Plan-und Eckmesserköpfe	346
AEM90-WNG.. -H	End Mills	Schafffräser	266	AFM90-490..	Face Milling	Plan-und Eckmesserköpfe	338
AEM90-XC..	End Mills	Schafffräser	268	AFM90-4N..	Face Milling	Plan-und Eckmesserköpfe	346
AEM90-XD..	End Mills	Schafffräser	267	AFM90-AD..	Face Milling	Plan-und Eckmesserköpfe	324-325
AEM90-XN..	End Mills	Schafffräser	269	AFM90-AN..	Face Milling	Plan-und Eckmesserköpfe	327-328-329
AEM90-XO..	End Mills	Schafffräser	268	AFM90-AO..	Face Milling	Plan-und Eckmesserköpfe	329
AEM90-ZC..	End Mills	Schafffräser	269	AFM90-AP..	Face Milling	Plan-und Eckmesserköpfe	330-331
AEM90-ZP..	End Mills	Schafffräser	270	AFM90-AX..	Face Milling	Plan-und Eckmesserköpfe	331
AEM95(C)-XD..	Modular End Mills	Einschraubfräser	291	AFM90-BD..	Face Milling	Plan und Eckmesserköpfe	332
AEMR(C)-RD..	Face and Copy End Mills	Kopier - und Schafffräser	271	AFM90C-TP..	Face Milling	Plan-und Eckmesserköpfe	353
AEMR-QP..	Face and Copy Mills	Kopier - und Schafffräser	274	AFM90-LO..	Face Milling	Plan-und Eckmesserköpfe	335-336
AEMR-QP..	Modular End Mills	Einschraubfräser	295	AFM90-R290..	Face Milling	Plan-und Eckmesserköpfe	337
AEMR-RC..	Modular End Mills	Einschraubfräser	292	AFM90-R390..	Face Milling	Plan-und Eckmesserköpfe	337
AEMR-RD..	Face and Copy Mills	Kopier - und Schafffräser	273	AFM90-RT..	Face Milling	Plan-und Eckmesserköpfe	338
AEMR-RD..	Modular End Mills	Einschraubfräser	294	AFM90-SE..	Face Milling	Plan-und Eckmesserköpfe	340
AEMR-RP..	Face and Copy Mills	Kopier - und Schafffräser	271-272	AFM90-SP..	Face Milling	Plan-und Eckmesserköpfe	341
AEMR-RP..	Modular End Mills	Einschraubfräser	292-293	AFM90-TN..	Face Milling	Plan-und Eckmesserköpfe	342
AEMR-RY..	Face and Copy End Mills	Kopier - und Schafffräser	272	AFM90-TP..	Face Milling	Plan-und Eckmesserköpfe	342
AEMR-RY..	Modular End Mills	Einschraubfräser	293	AFM90-VC2205.. -H	Face Milling	Plan-und Eckmesserköpfe	343
AET	Eccentric Adaptör For U-Drill	Exzentrischer Adapter für Vollbohrer	230	AFM90-WN..	Face Milling	Plan-und Eckmesserköpfe	344
AFM42C-XD..	Face Milling	Plan und Eckmesserköpfe	312	AFM90-WNG0.. -H	Face Milling	Plan-und Eckmesserköpfe	343
AFM43(C)-OD..	Face Milling	Plan-und Eckmesserköpfe	312-313	AFM90-XN..	Face Milling	Plan-und Eckmesserköpfe	345
AFM43(C)-OF..	Face Milling	Plan-und Eckmesserköpfe	313-351	AFM90-XO..	Face Milling	Plan-und Eckmesserköpfe	345
AFM43-ON..	Face Milling	Plan-und Eckmesserköpfe	314	AFMR(C)-RD..	Face and Copy Milling	Kopier - und Schafffräser	348
AFM44-ON..	Face Milling	Plan-und Eckmesserköpfe	314	AFMR-QP..	Face and Copy Milling	Kopier - und Schafffräser	350
AFM45(L)-HN..	Face Milling	Plan-und Eckmesserköpfe	315	AFMR-RC..	Face and Copy Milling	Kopier - und Schafffräser	347
AFM45(L)-SE..	Face Milling	Plan-und Eckmesserköpfe	316-317	AFMR-RP..	Face and Copy Milling	Kopier - und Schafffräser	349
AFM45(S)-SE	Face Milling	Plan-und Eckmesserköpfe	316	AFMR-RY..	Face and Copy Milling	Kopier - und Schafffräser	350
AFM45C(L)-HN..	Face Milling	Plan-und Eckmesserköpfe	351	AHFM(C)-JD..	High Feed Milling Tools	Hochvorschubfräser	357
AFM45C(L)-SN..	Face Milling	Plan-und Eckmesserköpfe	317-318-319	AHFM(C)-SD..	High Feed End Mills	Hochvorschubschafffräser	280
AFM45C-ON..	Face Milling	Plan-und Eckmesserköpfe	320	AHFM(C)-SD..	High Feed Milling Tools	Hochvorschubfräser	358
AFM45C-XN..	Face Milling	Plan-und Eckmesserköpfe	352	AHFM(C)-SD..	Modular High Feed End Mills	Hochvorschubeinschraubfräser	300
AFM45-NN..	Face Milling	Plan-und Eckmesserköpfe	315	AHFM(C)-WD..	High Feed End Mills	Hochvorschubschafffräser	283-284
AFM45-ON..	Face Milling	Plan-und Eckmesserköpfe	319	AHFM(C)-WD..	High Feed Milling Tools	Hochvorschubfräser	360
AFM45-SA..	Face Milling	Plan-und Eckmesserköpfe	318	AHFM(L)-WN..	High Feed Milling Tools	Hochvorschubfräser	361
AFM45-XN..	Face Milling	Plan-und Eckmesserköpfe	320	AHFM-BL..	High Feed End Mills	Hochvorschubschafffräser	276
AFM66-PN..	Face Milling	Plan-und Eckmesserköpfe	321	AHFM-BL..	High Feed Milling Tools	Hochvorschubfräser	354
AFM67-PN..	Face Milling	Plan-und Eckmesserköpfe	321	AHFM-BL..	Modular High Feed End Mills	Hochvorschubeinschraubfräser	295
AFM75-AP..	Face Milling	Plan-und Eckmesserköpfe	322	AHFM-BN..	High Feed End Mills	Hochvorschubschafffräser	274
AFM75C-SP..	Face Milling	Plan-und Eckmesserköpfe	352	AHFM-C-JD..	High Feed End Mills	Hochvorschubschafffräser	276
AFM75-XO..	Face Milling	Plan-und Eckmesserköpfe	322	AHFM-C-JD..	Modular High Feed End Mills	Hochvorschubeinschraubfräser	299
AFM88C-SN..	Face Milling	Plan-und Eckmesserköpfe	323-324-325-353	AHFM-C-WD..	Modular High Feed End Mills	Hochvorschubeinschraubfräser	302-303
AFM88-SN..	Face Milling	Plan-und Eckmesserköpfe	321	AHFM-ED..	Modular High Feed End Mills	Hochvorschubeinschraubfräser	296
AFM89-SN..	Face Milling	Plan-und Eckmesserköpfe	325	AHFM-EN..	High Feed End Mills	Hochvorschubschafffräser	277
AFM90(L)-LN..	Face Milling	Plan-und Eckmesserköpfe	332-333-334-335-336	AHFM-EN..	High Feed Milling Tools	Hochvorschubfräser	355
				AHFM-EN..	Modular High Feed End Mills	Hochvorschubeinschraubfräser	297
				AHFM-EO..	High Feed End Mills	Hochvorschubschafffräser	275

KOD / CODE	AÇIKLAMA / DESCRIPTION	BESCHREIBUNG	S.N. / P.N. SEITE
AHFM-EP..	High Feed End Mills	Hochvorschubschafffräser	275
AHFM-EP..	High Feed Milling Tools	Hochvorschubfräser	355
AHFM-EP..	Modular High Feed End Mills	Hochvorschubeinschraubfräser	296
AHFM-JD..	High Feed Milling Tools	Hochvorschubfräser	278
AHFM-JD..	Modular High Feed End Mills	Hochvorschubeinschraubfräser	299
AHFM-LN..	High Feed End Mills	Hochvorschubschafffräser	278
AHFM-LN..	Modular High Feed End Mills	Hochvorschubeinschraubfräser	298
AHFM-LN0303.. -H	Modular End Mills	Hochvorschubschafffräser	276
AHFM-LN0303.. -H	Modular ( Screw Type ) Highfeed End Mills	Hochvorschubschafffräser	296
AHFM-LN0303.. -H	High Feed Milling Tools	Hochvorschubfräser	356
AHFM-LO..	High Feed End Mills	Hochvorschubschafffräser	279
AHFM-LO..	High Feed Milling Tools	Hochvorschubfräser	356
AHFM-LO..	Modular High Feed End Mills	Hochvorschubeinschraubfräser	298
AHFM-LP..	High Feed End Mills	Hochvorschubschafffräser	280
AHFM-SO..	High Feed End Mills	Hochvorschubschafffräser	281
AHFM-SO..	High Feed Milling Tools	Hochvorschubfräser	359
AHFM-SO..	Modular High Feed End Mills	Hochvorschubeinschraubfräser	300-301
AHFM-SP..	High Feed End Mills	Hochvorschubschafffräser	281
AHFM-SP..	High Feed Milling Tools	Hochvorschubfräser	359
AHFM-SP..	Modular High Feed End Mills	Hochvorschubeinschraubfräser	302
AHFM-WN..	High Feed End Mills	Hochvorschubschafffräser	284
AHFM-WN..	Modular High Feed End Mills	Hochvorschubeinschraubfräser	303
AHFM-WO..	High Feed End Mills	Hochvorschubschafffräser	285
AHFM-YO..	High Feed End Mills	Hochvorschubschafffräser	283
AHFM-YP..	High Feed End Mills	Hochvorschubschafffräser	282
AHFM-YP..	Modular High Feed End Mills	Hochvorschubeinschraubfräser	301
AHM ..	Helix Chamfer Milling Tools	Helix-Fasfräser	244
AHM90-AP..	Helix End Mills	Wendelschafffräser	310
AHM90-AP1204.. -H	Helix End Mills	Wendelschafffräser	310
AIKT-123-R/L ..	Internal Grooving Tool Holders	Innen - Stechhalter	190
AIKT-154.91-R/L ..	Internal Grooving Tool Holders	Innen - Stechhalter	190
AIKT-GP-R/L ..	Internal Grooving Tool Holders	Innen - Stechhalter	194
AIKT-HK-R/L ..	Internal Grooving Tool Holders	Innen - Stechhalter	189
AIKT-H-R/L ..	Internal Grooving Tool Holders	Innen - Stechhalter	188
AIKT-HS223-R/L ..	Internal Grooving Tool Holders	Innen - Stechhalter	189
AIKT-IGE-R/L ..	Internal Grooving Tool Holders	Innen - Stechhalter	192
AIKT-IGI-R/L ..	Internal Grooving Tool Holders	Innen - Stechhalter	192
AIKT-IG-R/L ..	Internal Grooving Tool Holders	Innen - Stechhalter	193
AIKT-I-R/L ..	Internal Grooving Tool Holders	Innen - Stechhalter	193
AIKT-ITG-R/L ..	Internal Grooving Tool Holders	Innen - Stechhalter	194
AIKT-KG-R/L ..	Internal Grooving Tool Holders	Innen - Stechhalter	188
AIKT-KM-R/L ..	Internal Grooving Tool Holders	Innen - Stechhalter	189
AIKT-K-R/L ..	Internal Grooving Tool Holders	Innen - Stechhalter	187
AIKT-MB..	Mini Grooving Tool	Mini - Stechwerkzeuge	197
AIKT-QC..-R/L ..	Internal Grooving Tool Holders	Innen - Stechhalter	195
AIKT-RD-R/L ..	Internal Grooving Tool Holders	Innen - Stechhalter	191
AIKT-SGC-R ..	Internal Grooving Tool Holders	Innen - Stechhalter	196
AIKT-TD-R/L ..	Internal Grooving Tool Holders	Innen - Stechhalter	191
AIKT-TG-R/L ..	Internal Grooving Tool Holders	Innen - Stechhalter	195
AIKT-ZCC2-R/L ..	Internal Grooving Tool Holders	Innen - Stechhalter	196

KOD / CODE	AÇIKLAMA / DESCRIPTION	BESCHREIBUNG	S.N. / P.N. SEITE
AKCR ..	Adjustable Rough Boring Heads Cartridge	Einstellbare Schrupp - Spindelkopf Kurzdrehhalter	239
AKL-123 ..	Blades	Stechschwert	182
AKL-I ..	Blades	Stechschwert	181
AKL-SGC ..	Blades	Stechschwert	180
AKL-TD ..	Blades	Stechschwert	181
AKSR ..	Adjustable Rough Boring Heads Cartridge	Einstellbare Schrupp - Spindelkopf Kurzdrehhalter	239
ALBU ..	Blocks For Blades	Spannblock für Stechschwert	182
ALKT-ZCC2-R/L ..	Face External Grooving Tool Holders	Axial-Stechhalter L-Type	180
APMR-BNM..	Ball Nose End Mills	Kopier-Schafffräser	304
APMR-BNM.. -H	Modular ( Screw Type ) End Mills	Einschraubfräser	306
APMR-P32..	Ball Nose End Mills	Kopier-Schafffräser	305
APMR-P32..	Ball Nose Modular End Mills	Modulare Einschraub - Kugelfräser	306
APMR-RO..	Ball Nose End Mills	Kopier-Schafffräser	304
APMR-SWB..	Ball Nose Modular End Mills	Modulare Einschraub - Kugelfräser	307
APMR-XP..	Ball Nose End Mills	Kopier-Schafffräser	305
APMR-XP..	Ball Nose Modular End Mills	Modulare Einschraub - Kugelfräser	307
ASDM-CC..	Disc Milling	Scheibenfräser	365
ASDM-SPGT..	Disc Milling	Scheibenfräser	364
ASTB-..	Swiss Easy Change Tools	Swiss Easy Change Tools	87
ATM..	Thread Milling Tools	Gewindefräswerkzeuge	308
ATM60..	Thread Milling Tools	Gewindefräswerkzeuge	309
ATSM90-CC..	T Slot Milling	T Nutenfräser	362
ATSM90-SP..	T Slot Milling	T Nutenfräser	363
ATSMR-RD..	T Slot Milling	T Nutenfräser	363
ATTB ..	Anti Vibration Tool	Schwingungsgedämpfte Bohrstangen	131
ATTC ..	Anti Vibration Tool	Schwingungsgedämpfte Bohrstangen	134
ATTC- .. SCLCR/L ..	Anti Vibration Tool	Schwingungsgedämpfte Bohrstangen	132
ATTC- .. SDUCR/L ..	Anti Vibration Tool	Schwingungsgedämpfte Bohrstangen	132
ATTC- .. SVUCR/L ..	Anti Vibration Tool	Schwingungsgedämpfte Bohrstangen	133
ATTC- .. TCLNR/L ..	Anti Vibration Tool	Schwingungsgedämpfte Bohrstangen	134
ATTC- .. TDUNR/L ..	Anti Vibration Tool	Schwingungsgedämpfte Bohrstangen	133
ATUM .. xD2 KDR ..	U-Drill	Vollbohrer	221
ATUM .. xD2 SP ..	U-Drill	Vollbohrer	209-210
ATUM .. xD2 SPGT ..	U-Drill	Vollbohrer	215
ATUM .. xD2 WCM ..	U-Drill	Vollbohrer	202-203
ATUM .. xD3 KDR ..	U-Drill	Vollbohrer	222
ATUM .. xD3 SO ..	U-Drill	Vollbohrer	219
ATUM .. xD3 SP ..	U-Drill	Vollbohrer	211-212
ATUM .. xD3 SPGT ..	U-Drill	Vollbohrer	216-217
ATUM .. xD3 WCM ..	U-Drill	Vollbohrer	204-205
ATUM .. xD4 KDR ..	U-Drill	Vollbohrer	221
ATUM .. xD4 SO ..	U-Drill	Vollbohrer	220
ATUM .. xD4 SP ..	U-Drill	Vollbohrer	214



KOD / CODE	AÇIKLAMA / DESCRIPTION	BESCHREIBUNG	S.N. / PN. SEITE
ATUM .. xD4 SPGT ..	U-Drill	Vollbohrer	218
ATUM .. xD4 WCM ..	U-Drill	Vollbohrer	206-207
ATUM .. xD5 SP ..	U-Drill	Vollbohrer	214
ATUM .. xD5 WCM ..	U-Drill	Vollbohrer	208
ATUM xD2 SOMT ..	U-Drill	Vollbohrer	223
ATUM xD3 880 ..	U-Drill	Vollbohrer	227
ATUM xD3 SOMT ..	U-Drill	Vollbohrer	224
ATUM xD4 SOMT ..	U-Drill	Vollbohrer	225
ATUM xD5 SOMT ..	U-Drill	Vollbohrer	226
ATW-..	Whirling Toolholders	Wirbelnde Werkzeughalter	27
AVTT..	Screwed Tool Holders	Aufnahme für Einschraubfräser	308
B11..	Valve Seat Inserts	Wendeplatten für Ventilsitzbearbeitung	24-25
B41.. - B42..	Broaching Inserts	Wendplatten für Nutbearbeitung	18-19-20
CCLNR/L ..	External Tool Holders	Außen-Drehhalter	65
CDJNR/L ..	External Tool Holders	Außen-Drehhalter	65
CDNNN ..	External Tool Holders	Außen-Drehhalter	66
CKJNR/L ..	External Tool Holders	Außen-Drehhalter	64
CKUNR/L ..	Internal Tool Holders	Außen-Drehhalter	98
CRDCN ..	External Tool Holders	Außen-Drehhalter	66
CRDCR/L ..	External Tool Holders	Außen-Drehhalter	67
CSDNN ..	External Tool Holders	Außen-Drehhalter	67
CSKNR/L ..	External Tool Holders	Außen-Drehhalter	68
CSRNR/L ..	External Tool Holders	Außen-Drehhalter	68
CSSNR/L ..	External Tool Holders	Außen-Drehhalter	69
CTJNR/L ..	External Tool Holders	Außen-Drehhalter	69
E/SCLCR/L ..	Boring Bars SET	Bohrstangen Set	127
E/SDUCR/L ..	Boring Bars SET	Bohrstangen Set	128
E/STFCR/L ..	Boring Bars	Bohstangen	126
E/STUPR/L ..	Boring Bars	Bohstangen	126
MCLNR/L ..	Internal Tool Holders	Innen-Drehhalter	100
MDUNR/L ..	Internal Tool Holders	Innen-Drehhalter	100
MTENN ..	External Tool Holders	Außen-Drehhalter	49
MTFNR/L ..	Internal Tool Holders	Innen-Drehhalter	101
MTJNR/L ..	External Tool Holders	Außen-Drehhalter	49
MT-NR/L ..	Internal Tool Holders	Innen-Drehhalter	101
MTQNR/L ..	Internal Tool Holders	Innen-Drehhalter	102
MTUNR/L ..	Internal Tool Holders	Innen-Drehhalter	102
MWLNR/L ..	External Tool Holders	Außen-Drehhalter	50
MWLNR/L ..	Internal Tool Holders	Innen-Drehhalter	103
MWMNN ..	External Tool Holders	Außen-Drehhalter	50
PCBNR/L ..	External Tool Holders	Außen-Drehhalter	52
PCLNR/L ..	External Tool Holders	Außen-Drehhalter	52
PCLNR/L ..	Internal Tool Holders	Innen-Drehhalter	105
PCLNR/L...-H	External Turning Toolholders With Coolant Tools	Interne Kühlung Aussen - Drehhalter	60
PCMNN ..	External Tool Holders	Außen-Drehhalter	53
PDJNR/L ..	External Tool Holders	Außen-Drehhalter	53
PDJNR/L ..-H	External Turning Toolholders With Coolant Tools	Interne Kühlung Aussen - Drehhalter	60

KOD / CODE	AÇIKLAMA / DESCRIPTION	BESCHREIBUNG	S.N. / PN. SEITE
PDNNN ..	External Tool Holders	Außen-Drehhalter	54
PDNNN-H	External Turning Toolholders With Coolant Tools	Interne Kühlung Aussen - Drehhalter	61
PDQNR/L ..	Internal Tool Holders	Innen-Drehhalter	106
PDUNR/L ..	Internal Tool Holders	Innen-Drehhalter	107
PDXNR/L ..	Internal Tool Holders	Innen-Drehhalter	106
PSBNR/L ..	External Tool Holders	Außen-Drehhalter	54
PSDNN ..	Cartridge	Kassette	146
PSDNN ..	External Tool Holders	Außen-Drehhalter	55
PSKNR/L ..	Cartridge	Kassette	144
PSKNR/L ..	External Tool Holders	Außen-Drehhalter	55
PSKNR/L ..	Internal Tool Holders	Innen-Drehhalter	108
PSRNR/L ..	Cartridge	Kassette	145
PSSNR/L ..	External Tool Holders	Außen-Drehhalter	56
PTFNR/L ..	Cartridge	Kassette	145
PTFNR/L ..	External Tool Holders	Außen-Drehhalter	56
PTGNR/L ..	External Tool Holders	Außen-Drehhalter	57
PTJNR/L ..	External Tool Holders	Außen-Drehhalter	57
PTTNR/L ..	External Tool Holders	Außen-Drehhalter	58
PTUNR/L ..	Internal Tool Holders	Innen-Drehhalter	109
PWLNRL ..	External Tool Holders	Außen-Drehhalter	58
PWLNRL ..	Internal Tool Holders	Innen-Drehhalter	110
PWLNRL/L ..-H	External Turning Toolholders With Coolant Tools	Interne Kühlung Aussen - Drehhalter	61
S/SCLCR/L ..	Boring Bars SET	Bohrstangen Set	127
S/SDUCR/L ..	Boring Bars SET	Bohrstangen Set	128
SCACR/L ..	Engine Overhaul Cartridge	Motorüberholungskassette	139
SCACR/L ..	External Tool Holders	Außen-Drehhalter	71
SCACR/L ..-S	External Tool Holders Swiss Type	Außen-Drehhalter Swiss Type	83
SCFCR/L	Spare Parts Of Cartridge	Ersatzteile für Kassette	146
SCFCR/L ..	Cartridge	Kassette	141
SCFCR/L ..	Internal Tool Holders	Innen-Drehhalter	113
SCLCR/L ..	Boring Bars With Carbide Shank	Bohrstangen mit Hartmetallschaft	125
SCLCR/L ..	External Tool Holders	Außen-Drehhalter	71
SCLCR/L ..	Internal Tool Holders	Innen-Drehhalter	112
SCLCR/L ..-S	External Tool Holders Swiss Type	Außen-Drehhalter Swiss Type	84
SCMCN ..	Engine Overhaul Cartridge	Motorüberholungskassette	140
SCMCN ..	External Tool Holders	Außen-Drehhalter	72
SCSCR/L	Spare Parts Of Cartridge	Ersatzteile für Kassette	146
SCSCR/L ..	Cartridge	Kassette	142
SDACR/L ..-S	External Tool Holders Swiss Type	Außen-Drehhalter Swiss Type	84
SD-CR/L ..	Internal Tool Holders	Innen-Drehhalter	113
SDHCR/L ..	External Tool Holders	Außen-Drehhalter	72
SDJCR/L ..	External Tool Holders	Außen-Drehhalter	73
SDJCR/L ..	Sec Tools	Sec Tools	88
SDJCR/L ..-S	External Tool Holders Swiss Type	Außen-Drehhalter Swiss Type	85
SDJCR/L..	Swiss Easy Change Tools	Swiss Easy Change Tools	88
SDNCN ..	External Tool Holders	Außen-Drehhalter	73
SDPCR/L ..	Internal Tool Holders	Innen-Drehhalter	114
SDQCR/L ..	Internal Tool Holders	Innen-Drehhalter	114

KOD / CODE	AÇIKLAMA / DESCRIPTION	BESCHREIBUNG	S.N. / P.N. SEITE
SDUCR/L ..	Boring Bars With Carbide Shank	Bohrstangen mit Hartmetall-schaft	125
SDUCR/L ..	Internal Tool Holders	Innen-Drehhalter	115
SDXCR/L ..	Internal Tool Holders	Innen-Drehhalter	116
SER/L ..	External Threading Tool Holders	Werkzeughalter für Außen-gewinde	150
SER/L ..	Sec Tools	Sec Tools	89
SIR/L ..	Internal Threading Tool Holders	Werkzeughalter für Innen-gewinde	151
SRDCN ..	External Tool Holders	Außen-Drehhalter	74
SRDCR/L ..	External Tool Holders	Außen-Drehhalter	75
SRGCR/L ..	External Tool Holders	Außen-Drehhalter	75
SRGCR/L ..	Internal Tool Holders	Innen-Drehhalter	117
SRHCR/L ..	External Tool Holders	Außen-Drehhalter	76
SRSCN..	Engine Overhaul Cartridge	Motorüberholungskassette	140
SRXCR/L ..	External Tool Holders	Außen-Drehhalter	76
SSDCN ..	External Tool Holders	Außen-Drehhalter	77
SSKCR/L ..	Cartridge	Kassette	142
SSSCR/L ..	External Tool Holders	Außen-Drehhalter	77
SSSCR/L ..	Internal Tool Holders	Innen-Drehhalter	117
STCCN ..	External Tool Holders	Außen-Drehhalter	79
ST-CR/L ..	Internal Tool Holders	Innen-Drehhalter	118
STFCR/L	Spare Parts Of Cartridge	Ersatzteile für Kassette	146
STFCR/L ..	Cartridge	Kassette	143
STFCR/L ..	External Tool Holders	Außen-Drehhalter	78
STFCR/L ..	Internal Tool Holders	Innen-Drehhalter	118
STGCR/L ..	External Tool Holders	Außen-Drehhalter	78
STGCR/L ..S	External Tool Holders Swiss Type	Außen-Drehhalter Swiss Type	85
STJCR/L ..	External Tool Holders	Außen-Drehhalter	79
STSCR/L	Spare Parts Of Cartridge	Ersatzteile für Kassette	146
STSCR/L ..	Cartridge	Kassette	143
STTCR/L	Spare Parts Of Cartridge	Ersatzteile für Kassette	146
STTCR/L ..	Cartridge	Kassette	144
STUCR/L ..	External Tool Holders	Außen-Drehhalter	80
STUCR/L ..	Internal Tool Holders	Innen-Drehhalter	119
STUPR/L ..	Internal Tool Holders	Innen-Drehhalter	120
STXCR/L ..	Engine Overhaul Cartridge	Motorüberholungskassette	141
SVACR/L ..S	External Tool Holders Swiss Type	Außen-Drehhalter Swiss Type	86
SVHBR/L ..	External Tool Holders	Außen-Drehhalter	80
SVHCR/L ..	External Tool Holders	Außen-Drehhalter	81
SVJBR/L ..	External Tool Holders	Außen-Drehhalter	81
SVJBR/L ..	Internal Tool Holders	Innen-Drehhalter	120
SVJBR/L ..S	External Tool Holders Swiss Type	Außen-Drehhalter Swiss Type	86
SVJCR/L	Swiss Easy Change Tools	Swiss Easy Change Tools	88
SVJCR/L ..	External Tool Holders	Außen-Drehhalter	82
SVJCR/L ..	Internal Tool Holders	Innen-Drehhalter	123
SVJCR/L ..	Sec Tools	Sec Tools	88
SVJCR/L ..S	External Tool Holders Swiss Type	Außen-Drehhalter Swiss Type	87
SVQBR/L ..	Internal Tool Holders	Innen-Drehhalter	121
SVQCR/L ..	Internal Tool Holders	Innen-Drehhalter	121
SVUBR/L ..	Internal Tool Holders	Innen-Drehhalter	122

KOD / CODE	AÇIKLAMA / DESCRIPTION	BESCHREIBUNG	S.N. / P.N. SEITE
SVUCR/L ..	Internal Tool Holders	Innen-Drehhalter	122
SVVBN ..	External Tool Holders	Außen-Drehhalter	82
SVVCN ..	External Tool Holders	Außen-Drehhalter	83
SVXBR/L ..	Internal Tool Holders	Innen-Drehhalter	123
SWLCR ..	Internal Tool Holders	Innen-Drehhalter	124
SWUBR ..	Internal Tool Holders	Innen-Drehhalter	124
T09..	Whirling Inserts	Gewindewirbelplatte	28-29
T12.10	Poly-V Grooving Inserts	Poly-V Riemennuten	12
T20	Corner Reliefs Grooving Inserts	Eckreliefs Einstechplatten	16
TCBNR/L ..	External Tool Holders	Außen-Drehhalter	35
TCKNR/L ..	External Tool Holders	Außen-Drehhalter	35
TCLNR/L ..	External Tool Holders	Außen-Drehhalter	36
TCLNR/L ..	Internal Tool Holders	Innen-Drehhalter	94
TCLNR/L .. -H	External Turning Toolholders With Coolant Tools	Interne Kühlung Aussen - Drehhalter	45
TCMNN ..	External Tool Holders	Außen-Drehhalter	36
TCZNN ..	External Tool Holders	Außen-Drehhalter	37
TDHNR/L ..	External Tool Holders	Außen-Drehhalter	37
TDJNR/L ..	External Tool Holders	Außen-Drehhalter	38
TDJNR/L .. -H	External Turning Toolholders With Coolant Tools	Interne Kühlung Aussen - Drehhalter	45
TDNNN ..	External Tool Holders	Außen-Drehhalter	38
TDNHN-H	External Turning Toolholders With Coolant Tools	Interne Kühlung Aussen - Drehhalter	46
TD-NR/L ..	Internal Tool Holders	Innen-Drehhalter	94
TDQNR/L ..	Internal Tool Holders	Innen-Drehhalter	95
TDUNR/L ..	Internal Tool Holders	Innen-Drehhalter	95
TER/L ..	External Threading Tool Holders	Werkzeughalter für Außen-gewinde	152
TER/L ..	Sec Tools	Sec Tools	89
TIR/L ..	Internal Threading Tool Holders	Werkzeughalter für Innen-gewinde	153
TSDNN ..	External Tool Holders	Außen-Drehhalter	39
TSKNR/L ..	External Tool Holders	Außen-Drehhalter	39
TSKNR/L ..	Internal Tool Holders	Innen-Drehhalter	96
TSSNR/L ..	External Tool Holders	Außen-Drehhalter	40
TTENN ..	External Tool Holders	Außen-Drehhalter	40
TTGNR/L ..	External Tool Holders	Außen-Drehhalter	41
TTJNR/L ..	External Tool Holders	Außen-Drehhalter	41
TT-NR/L ..	Internal Tool Holders	Innen-Drehhalter	96
TTUNR/L ..	Internal Tool Holders	Innen-Drehhalter	97
TVHNR/L ..	External Tool Holders	Außen-Drehhalter	42
TVJNR/L ..	External Tool Holders	Außen-Drehhalter	42
TVUNR/L ..	Internal Tool Holders	Innen-Drehhalter	97
TVVNN ..	External Tool Holders	Außen-Drehhalter	43
TWLNLR/L ..	External Tool Holders	Außen-Drehhalter	43
TWLNLR/L ..	Internal Tool Holders	Innen-Drehhalter	98
TWLNLR/L .. -H	External Turning Toolholders With Coolant Tools	Interne Kühlung Aussen - Drehhalter	46
VST-B11..	Valve Seat Toolholders	Werkzeuge für Ventilsitzbe-arbeitung	23-24

KOD / CODE	AÇIKLAMA / DESCRIPTION	BESCHREIBUNG	S.N. / P.N. SEITE
AACN-..	Spare Parts	Ersatzteile	372
AADN-..	Spare Parts	Ersatzteile	372
AAL-..	Spare Parts	Ersatzteile	385
AARC-..	Spare Parts	Ersatzteile	372
AASD-..	Spare Parts	Ersatzteile	372
AASE-..	Spare Parts	Ersatzteile	372
AASN-..	Spare Parts	Ersatzteile	372
AATN-..	Spare Parts	Ersatzteile	372
AAV-..	Spare Parts	Ersatzteile	375-383
AAVN-..	Spare Parts	Ersatzteile	372
AAWN-..	Spare Parts	Ersatzteile	372
AAV-..	Spare Parts	Ersatzteile	378
ABK-..	Spare Parts	Ersatzteile	385
ABKS-..	Spare Parts	Ersatzteile	384
ABPL-..	Spare Parts	Ersatzteile	384
ACK-..	Spare Parts	Ersatzteile	373
ACS-..	Spare Parts	Ersatzteile	383
AEV-..	Spare Parts	Ersatzteile	379
AKS-..	Spare Parts	Ersatzteile	372
AKV-..	Spare Parts	Ersatzteile	374-375-376-377
AKY-..	Spare Parts	Ersatzteile	376
ALA-..	Spare Parts	Ersatzteile	385
ALV-..	Spare Parts	Ersatzteile	377
AMK-..	Spare Parts	Ersatzteile	373
AN-01..	Spare Parts	Ersatzteile	374
AOR-01	Spare Parts	Ersatzteile	384
APL-..	Spare Parts	Ersatzteile	377
APM-..	Spare Parts	Ersatzteile	378
AS-01	Spare Parts	Ersatzteile	383
ATK-..	Spare Parts	Ersatzteile	373
ATKH-..	Spare Parts	Ersatzteile	373
ATS-..	Spare Parts	Ersatzteile	372
AXR-01	Spare Parts	Ersatzteile	384
1008-..	Spare Parts	Ersatzteile	380
1015-..	Spare Parts	Ersatzteile	380-381
1020-..	Spare Parts	Ersatzteile	379
1108-..	Spare Parts	Ersatzteile	380
1120-..	Spare Parts	Ersatzteile	381
1204-..	Spare Parts	Ersatzteile	379
1208-..	Spare Parts	Ersatzteile	379
1210-..	Spare Parts	Ersatzteile	379
1215-..	Spare Parts	Ersatzteile	379
1220-..	Spare Parts	Ersatzteile	379
1315-..	Spare Parts	Ersatzteile	380-381
1415-..	Spare Parts	Ersatzteile	379
1420-..	Spare Parts	Ersatzteile	381
1510-..	Spare Parts	Ersatzteile	380
1515-..	Spare Parts	Ersatzteile	381
1520-..	Spare Parts	Ersatzteile	381

KOD / CODE	AÇIKLAMA / DESCRIPTION	BESCHREIBUNG	S.N. / P.N. SEITE
1615-..	Spare Parts	Ersatzteile	380-381
1620-..	Spare Parts	Ersatzteile	381
1707-..	Spare Parts	Ersatzteile	381
1710-..	Spare Parts	Ersatzteile	381
1720-..	Spare Parts	Ersatzteile	379
1904-..	Spare Parts	Ersatzteile	377
2004-..	Spare Parts	Ersatzteile	377
2306-..	Spare Parts	Ersatzteile	383
2405-..	Spare Parts	Ersatzteile	383
2406-..	Spare Parts	Ersatzteile	383
2407-..	Spare Parts	Ersatzteile	383
2408-..	Spare Parts	Ersatzteile	383
2503-..	Spare Parts	Ersatzteile	383
2504-..	Spare Parts	Ersatzteile	383
2505-..	Spare Parts	Ersatzteile	383
2506-..	Spare Parts	Ersatzteile	383
2508-..	Spare Parts	Ersatzteile	381
2510-..	Spare Parts	Ersatzteile	383
2514-..	Spare Parts	Ersatzteile	383
2525-..	Spare Parts	Ersatzteile	383
2600-..	Spare Parts	Ersatzteile	382
2702-..	Spare Parts	Ersatzteile	382
2703-..	Spare Parts	Ersatzteile	382
2704-..	Spare Parts	Ersatzteile	382
2705-..	Spare Parts	Ersatzteile	382
2715-..	Spare Parts	Ersatzteile	382
2725-..	Spare Parts	Ersatzteile	382
3006-..	Spare Parts	Ersatzteile	380
3007-..	Spare Parts	Ersatzteile	380
3008-..	Spare Parts	Ersatzteile	380
3010-..	Spare Parts	Ersatzteile	380
3015-..	Spare Parts	Ersatzteile	380-381
3108-..	Spare Parts	Ersatzteile	380
4006-..	Spare Parts	Ersatzteile	380
4008-..	Spare Parts	Ersatzteile	380
4010-..	Spare Parts	Ersatzteile	380
4015-..	Spare Parts	Ersatzteile	380-381
4020-..	Spare Parts	Ersatzteile	381
4108-..	Spare Parts	Ersatzteile	380
4115-..	Spare Parts	Ersatzteile	381
4420-..	Spare Parts	Ersatzteile	381
4515-..	Spare Parts	Ersatzteile	381
4615-..	Spare Parts	Ersatzteile	381
80-..	Spare Parts	Ersatzteile	385
81-..	Spare Parts	Ersatzteile	385





*konusulan*  
*the spoken kalite...*  
*quality...*



[www.akko.com.tr](http://www.akko.com.tr)



***konusulan***  
***the spoken kalite...***  
***quality...***









AKKO®



KATALOĞU  
CATALOGUE

18. VERSİYON  
VERSION

TÜRKÇE  
ENGLISH  
DEUTSCH



AKKO®  
MAKİNA TAKİM SAN. TİC. LTD. ŞTİ.

Konya Organize Sanayi Bölgesi  
Işıktepe Sk. No:6 P.K. 42250  
Selçuklu / KONYA / TÜRKİYE

Tel : +90 332 239 17 57 (pbx)  
Fax : +90 332 239 17 52  
GPS: 37.973262 N / 32.604158 E

www.akk.com.tr  
akko@akk.com.tr  
export@akk.com.tr



/akk.com.tr  
Yenilikler için bizi takip edin!  
Follow us for news!  
Für Neuheiten bitte uns folgen